

**MEDID**

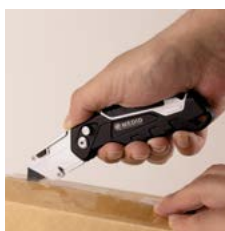

**CATÁLOGO  
CATALOGUE  
KATALOG**

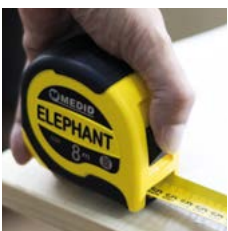



5

6

7

8

9

10

11

12

13

14

15

16

17

18

19

20

00000

M17

II

CE



## ES **El especialista en medición**

Desde su fundación en 1932, Medid siempre se ha caracterizado por su decidida apuesta por la innovación. En este empeño por liderar el sector de la medición, nuestro equipo de diseñadores y técnicos está permanentemente investigando y desarrollando nuevas soluciones técnicas, para adaptarnos continuamente a las necesidades de los usuarios más exigentes.

## EN **The specialist in measurement**

Since its founding in 1932, Medid always been characterised by its strong commitment to innovation. In its endeavour to lead the field of measurement, our team of designers and technicians are constantly researching and developing new technical solutions to continuously adapt to the needs of the most demanding users.

## DE **Der Spezialist für Messwerkzeuge**

Seit seiner Gründung im Jahre 1932 hat sich Medid schon immer durch sein entschlossenes Engagement für Innovationen ausgezeichnet. Mit dem Bestreben, führender Anbieter im Bereich der Messtechnik zu werden, unser Entwicklungs- und Technikerteam forscht und entwickelt ständig neue Lösungen, um kontinuierlich die Anforderungen unserer anspruchsvollsten Kunden zu erfüllen.

**FLEXÓMETROS / MEASURING TAPES / ROLLBANDMAßE**

Flexómetros UPS Clase I + Inox	
Class I UPS measuring tapes	
Rollbandmaße UPS Klasse I + Edelstahl	14
Flexómetros Inox + No conductivo + Nylon Coated	
Inox + non-conductive + nylon coated measuring tapes	
Rollbandmaße Edelstahl + Nicht leitend + Nylonbeschichtet	15
Flexómetros UPS + Nylon Coated	
UPS measuring tapes + Nylon Coated	
Rollbandmaße UPS + Nylonbeschichtet	16
Flexómetros modelo Elephant	
Elephant measuring Tapes	
Rollbandmaße modell Elephant	17
Flexómetros de alta Visibilidad	
High Visibility measuring tapes	
Rollbandmaße mit hoher Sichtbarkeit	18
Flexómetros con funda de goma	
Measuring tapes with rubber cover	
Rollbandmaße mit gummischutz	19
Flexómetro Ergo + Star cromados	
Ergo + Star chromed measuring tapes	
Ergo + Star verchromtes Rollbandmaß	20
Flexómetros Star ABS	
Star line Measuring tapes. ABS casing	
Rollbandmaße Star ABS	21
Flexómetros especiales	
Special measuring tapes	
Spezielle Rollbandmaße	22

**EXPOSITORES / DISPLAYS**

Expositor de mostrador	
Counter displays	
Theken-Displays	24
Expositor de suelo	
Medid Displays	
Boden-Displays	25

**CINTAS MÉTRICAS / LONG TAPES / MAßBÄNDER**

Cintas métricas de fibra de vidrio	
Fiberglass long tapes	
Fiberglas-Maßbänder	27
Cintas métricas metálicas	
Steel long tapes	
Metall-Maßbänder	30
Sondas	
Tank dipping tapes	
Tankbandmasse	32

**MEDICIÓN / MEASUREMENT / MESSUNG**

Medición electrónica	
Electronic measurement	
Elektronische messung	34
Termómetros	
Thermometers	
Thermometer	40
Topómetros	
Road measuring wheels	
Messräder	43
Escuadras	
Squares	
Winkelmessgeräte	45
Escuadras y cartabón	
Set square and T-Square	
Winkel und lineal	46
Reglas y telescopio	
Rules and telescope	
Lineal und teleskopmessstab	47
Metros plegables y escalímetro	
Folding rules and aluminium scale rule	
Klappmaßbänder und dreikantmassstab aus aluminium	48
Calibres y transmisor-receptor bluetooth	
Calipers and bluetooth transceiver	
Schieblehren und bluetooth-transceiver	49
Calibres	
Calipers	
Messschieber	50
Metrología	
Metrology	
Messtechnik	52
Escuadras y puntas trazadoras	
Squares and marking points	
Winkel und Anreißspitzen	55
Compases	
Compasses	
Zirkel	56
Varios	
Miscellaneous	
Verschiedenes	57



■ NIVELES / LEVELS / WASSERWAAGEN	Niveles profesionales de alta precisión Professional levels of high accuracy Hochpräzise profi-wasserwaagen	59
	Nivel láser rotatorio y nivel óptico Rotatory laser level and optical level Selbstnivellierender rotationslaser und nivelliergerät	62
	Accesorios niveles láser Láser level accessories Zubehör Für linienlaser	63
	Niveles profesionales Professional levels Profi-wasserwaagen	67
	Niveles profesionales Professional levels Profi-wasserwaagen	70
	Escuadras + Regla nivel Squares + Ruler-Level Wasserwaage	73
	Niveles Star y otros accesorios de nivelación Star levels and other levelling accessories Star-niveaus und andere nivellierzubehör	74

■ MARCAJE / MARKING / KENNZEICHNUNG	Marcaje Marking Kennzeichnung	77
	Malla y cintas de baliza Mesh and barrier tapes Abspernetze und -bänder	90
	Plomadas trazadoras Chalk lines SchlagschnurrolleR	92
	Plomadas Plumb bobs Senklote aus verzinktem	93
	Polvos y sprays Pulver und Sprays Puder und Sprays	94

■ FLEXÓMETROS / MEASURING TAPES / ROLLBANDMASSE

■ CINTAS MÉTRICAS / LONG TAPES / MABBAND

■ MEDICIÓN / MEASUREMENT / MESSUNG

■ NIVELES / LEVELS / WASSERWAAGEN

■ CORTE / CUT / SCHNITT	Cutters Cutters Cutter	96
	Herramientas de corte Cutting tools Schneiderwerkzeuge	103
	Tijeras Scissors Scheren	105
	Discos de corte Cutting discs Trennscheiben	106
	Brocas Drills Bohrer	109
	Hilo de nylon Nylon thread Nylonfaden	111

■ HERRAMIENTAS / TOOLS / WERKZEUGE	Herramientas manuales Hand tools Handwerkzeuge	114
	Herramientas manuales - Tornillos de banco Hand tools - Vices Handwerkzeuge - Schraubstöcke	123
	Tornillos de banco - Mordazas Vices - Drills Schraubstöcke - Maschinenschraubstock	124
	Cajas de herramientas y organizadores Tool boxes and organizers Werkzeugkästen und organisatoren	126
	Porta - Herramientas Tool holders Werkzeughalter	128

Índice de referencias Reference Index Referenzverzeichnis	130
---	-----

■ MARCAJE / MARKING / KENNZEICHNUNG

■ CORTE / CUT / SCHNITT

■ HERRAMIENTAS / TOOLS / WERKZEUGE



## ES Especialistas en medición

**Medid General de Medición**, empresa líder en productos de medición con más de 90 años de experiencia. Fundada en 1932, Medid estuvo orientada en sus inicios hacia el campo de la medición con cintas de sastre y modista. Pionera en Europa en la introducción del flexómetro. En los años 50, ya era una firma reconocida a nivel mundial en la producción de este producto.

Líder en el sector de la medición lineal, aparte de herramientas de medición, disponemos de los mejores productos de nivelación, marcaje y corte para el profesional. Ofrecemos una amplia gama de productos con más de 1.500 referencias, que están disponibles en todo momento gracias a una excelente logística, garantizando una alta fiabilidad en el servicio. Además, nuestra amplia red de ventas nos permite mantener una gran cercanía con nuestros clientes en los principales países europeos.

## EN Measurement specialists

**Medid General de Medición**, a leading company in measurement products with more than 90 years of experience. Founded in 1932, Medid was initially oriented towards the field of measurement with tailor's and dressmaker's tapes. Pioneer in Europe in the introduction of the flexometer. In the 50s, it was already a globally recognized firm in the production of this product.

Leader in the linear measurement sector, in addition to measurement tools, we offer the best leveling, marking, and cutting products for professionals. We provide a wide range of products with over 1,500 references, available at all times thanks to excellent logistics, ensuring high reliability in service. Furthermore, our extensive sales network allows us to maintain a strong closeness with our customers in the main European countries.

## DE Messspezialisten

**Medid General de Medición**, ein führendes Unternehmen für Messprodukte mit mehr als 90 Jahren Erfahrung. Medid wurde 1932 gegründet und war zunächst auf den Bereich der Messung mit Maßbändern für Schneider ausgerichtet. Pionier in Europa bei der Einführung des Bandmasses. Bereits in den 50er Jahren war es ein weltweit anerkanntes Unternehmen in der Herstellung dieses Produkts.

Als Marktführer im Bereich der linearen Messtechnik bieten wir neben Messwerkzeugen auch die besten Produkte in den Bereichen Nivellierung, Markierung und Schneiden für den Profi an. Wir verfügen über eine breite Produktpalette mit über 1.500 Referenzen, die dank einer ausgezeichneten Logistik jederzeit verfügbar sind, wobei wir eine äußerst zuverlässigen Service bieten. Darüber hinaus sind wir dank unseres weitreichenden Vertriebsnetzes in der Lage, enge Beziehungen zu unseren Kunden in den wichtigsten europäischen Ländern zu unterhalten.





**ES Más de 90 años de experiencia**

Gran capacidad productiva (más de 3 millones de unidades anuales), con cinco unidades de producción, deslocalizada en tres países, con personal propio en origen para realizar un exhaustivo control de calidad, con gran capacidad para el desarrollo de proyectos a medida.

Firme vocación exportadora, llevamos más de 50 años exportando a los 5 continentes, estamos presentes en más de 30 países, y en múltiples ferias internacionales.

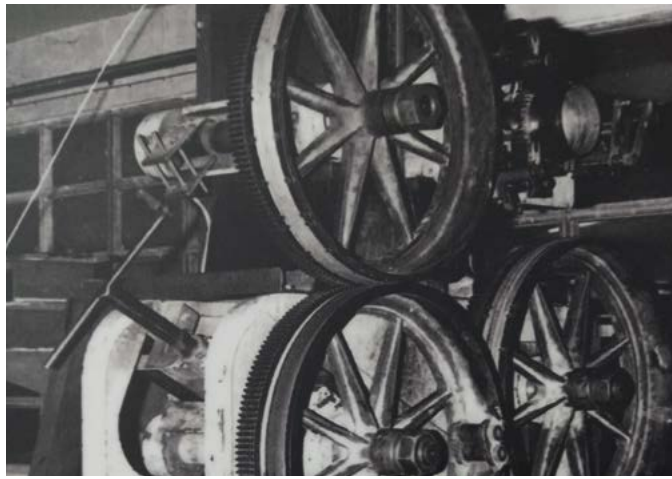

1932

1942

**EN More than 90 years of experience**

Large production capacity (more than 3 million units annually), with five production units, relocated to three countries, with its own personnel at source to carry out exhaustive quality control, with great capacity for the development of customized projects.

Firm export vocation, we have been exporting to all 5 continents for more than 50 years, we are present in more than 30 countries, and in multiple international fairs.



1952

1962

1972

**DE Mehr als 90 Jahre Erfahrung**

Große Produktionskapazität (mehr als 3 Millionen Einheiten pro Jahr), mit fünf Produktionseinheiten, die in drei Ländern verlagert sind, mit eigenem Personal vor Ort, das eine umfassende Qualitätskontrolle durchführt, mit großer Entwicklungsfähigkeit maßgeschneiderter Projekte.

Wir sind stark im Export tätig und exportieren seit mehr als 50 Jahren auf alle fünf Kontinente. Wir sind in mehr als 30 Ländern und auf mehreren internationalen Messen vertreten.



1982

1992

2002



2012

2022



ER-0642/2001



## ES Compromiso y calidad

**La calidad es una de nuestras prioridades**, nuestras certificaciones avalan la calidad de nuestros productos:

1. Certificado de aprobación del sistema de gestión de la calidad (Módulo H)
2. Empresa certificada UNE-EN ISO9001: 2015 por IQNet
3. Marcado de Conformidad CE, directiva comunitaria 2014/32/UE.

## EN Commitment and quality

**Quality is one of our priorities**, our certifications guarantee the quality of our products:

1. Certificate of approval for the Quality Management System (Module H)
2. UNE-EN ISO9001: 2015 certified company by IQNet
3. CE Conformity Marking, community directive 2014/32/EU

## DE Engagement und Qualität

**Qualität ist eine unserer prioritäten**, unsere Zertifizierungen garantieren die Qualität unserer Produkte:

1. Zertifikat zur Genehmigung des Qualitätsmanagementsystems (Modul H)
2. UNE-EN ISO9001: 2015 zertifiziertes Unternehmen von IQNet
3. CE-Konformitätskennzeichnung, Gemeinschaftsrichtlinie 2014/32/EU





## ES Innovación permanente

Desarrollamos productos de calidad para aplicaciones profesionales, nuestra gama está especialmente concebida para reforzar la ventaja competitiva de nuestro cliente, con soluciones innovadoras:

- Diferentes clases de precisión certificadas
- Cintas recubiertas de Nylon por extrusión
- Productos totalmente resistentes a la humedad (INOX)
- Cintas de alta visibilidad, graduaciones dimensionadas y de alto contraste
- Dispositivos de medición electrónica, por láser, infrarrojos, con conexión via Bluetooth con dispositivos móviles
- Nivelación electrónica y láser
- Cuchillas negras con acero SK2 al carbono

En Medid consideramos que las personas que forman parte de nuestro equipo son nuestro activo más valioso, profesionales que se caracterizan por su compromiso y dinamismo. En estrecha colaboración con nuestra amplia red comercial, pueden aportar toda nuestra experiencia para ofrecer soluciones competitivas y adaptadas a las necesidades de nuestros usuarios más exigentes.



## EN Permanent innovation

We develop quality products for professional applications, our range is specially designed to reinforce our client's competitive advantage, with innovative solutions:

- Different certified precision classes
- Nylon coated extrusion tapes
- Products totally resistant to humidity (INOX)
- High visibility tapes, sized and high contrast graduations
- Electronic measurement devices, laser, infrared, with connection via Bluetooth with mobile devices
- Electronic and laser leveling
- Black blades with SK2 carbon steel

At Medid we consider that the people who are part of our team are our most valuable asset, professionals who are characterized by their commitment and dynamism. In close collaboration with our extensive commercial network, they can contribute all our experience to offer competitive solutions adapted to the needs of our most demanding users.



## DE Permanente Innovation

Wir entwickeln Qualitätsprodukte für professionelle Anwendungen. Unser Sortiment ist speziell darauf ausgelegt, den Wettbewerbsvorteil unserer Kunden mit innovativen Lösungen zu stärken:

- Verschiedene zertifizierte Präzisionsklassen
- Nylonbeschichtete Extrusionsbänder
- Produkte, die absolut feuchtigkeitsbeständig sind (INOX)
- Gut sichtbare Bänder, große und kontrastreiche Abstufungen
- Elektronische Messgeräte, Laser, Infrarot, mit Verbindung über Bluetooth mit mobilen Geräten
- Elektronische und Lasernivellierung
- Schwarze Klingen aus SK2-Kohlenstoffstahl

Bei Medid sind wir davon überzeugt, dass die Menschen, die Teil unseres Teams sind, unser wertvollstes Kapital sind: Fachleute, die sich durch Engagement und Dynamik auszeichnen. In enger Zusammenarbeit mit unserem umfangreichen kommerziellen Netzwerk können wir unsere gesamte Erfahrung einbringen, um wettbewerbsfähige Lösungen anzubieten, die an die Bedürfnisse unserer anspruchsvollsten Benutzer angepasst sind.



# MARCAO DE CONFORMIDAD CE / CE CONFORMITY MARKING / EU-KONFORMITÄTS-KENNEICHNUNG

- ES Todos nuestros flexómetros y cintas métricas llevan el Marcado de Conformidad CE, en cumplimiento de la directiva comunitaria 2014/32/UE.
- EN All our measuring tape wear the CE Conformity Marking according to the ECC Metrological directives: 2014/32/EU.
- DE All unsere Rollbandmaße und Maßbänder sind in Übereinstimmung mit der EU-Richtlinie 2014/32/EU mit dem CE-Zeichen versehen.

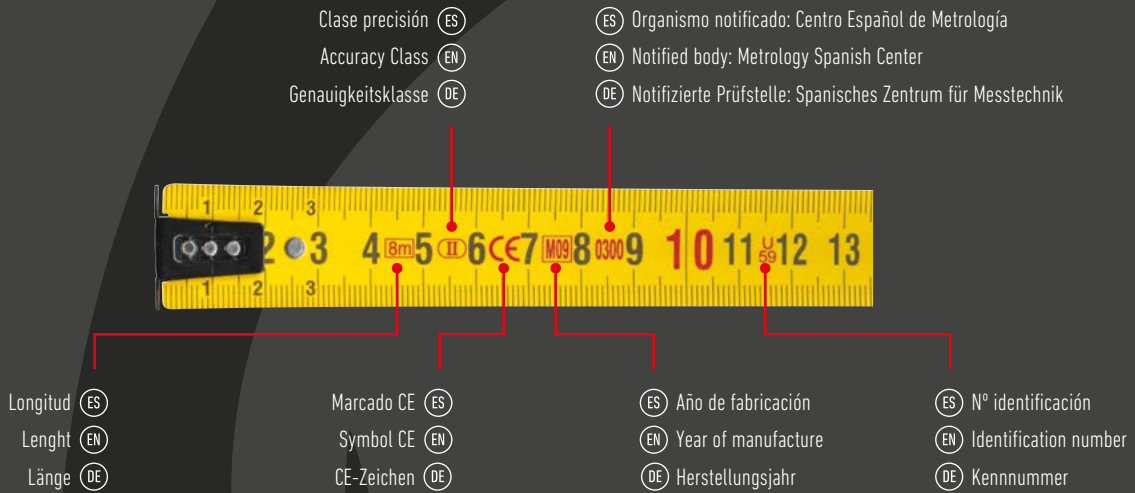

## CLASES DE PRECISIÓN / ACCURACY CLASSES / GENAUIGKEITSKLASSE

- ES MEDID, líder en el sector de la medición lineal, es el único fabricante capaz de ofrecer productos adaptados a las diferentes clases de precisión, para satisfacer las necesidades de los usuarios más exigentes. En la tabla inferior podrá ver las tolerancias máximas permitidas en cada clase de precisión, para que pueda optar por el modelo más acorde a sus necesidades.
- EN MEDID, leader in the field of linear measurement is the only manufacturer able to offer products adapted to the different accuracy classes, to meet the needs of the most demanding users. In the table below you can see the maximum tolerances permitted in each accuracy class, so you can choose the model that suits your needs.
- DE MEDID, Marktführer im Längenmessbereich, ist der einzige Hersteller, der in der Lage ist, Produkte anzubieten, die den unterschiedlichen Genauigkeitsklassen angepasst werden können, um so die Anforderungen der anspruchsvollsten Kunden zu befriedigen. In der nachstehenden Tabelle werden die maximal zulässigen Toleranzen jeder Genauigkeitsklasse aufgeführt, damit Sie sich das Ihren Bedürfnissen entsprechende Modell auswählen können.

	LONGITUD / TOLERANCIA LENGHT / TOLERANCE LÄNGE / TOLERANZ (±mm)									
PRECISIÓN ACCURACY GENAUIGKEIT	1 m	2 m	3 m	5 m	8 m	10 m	20 m	30 m	50 m	100 m
CLASE I	0,2	0,3	0,4	0,6	0,9	1,1	2,1	3,1	5,1	10,1
CLASE II	0,5	0,7	0,9	1,3	1,9	2,3	4,3	6,3	10,3	20,3
CLASE III	1,0	1,4	1,8	2,6	3,8	4,6	8,6	12,6	20,6	40,6

# FLEXÓMETROS ACERO INOXIDABLE / STAINLESS STEEL MEASURING TAPES / ROLLBANDMASSE AUS EDELSTAHL

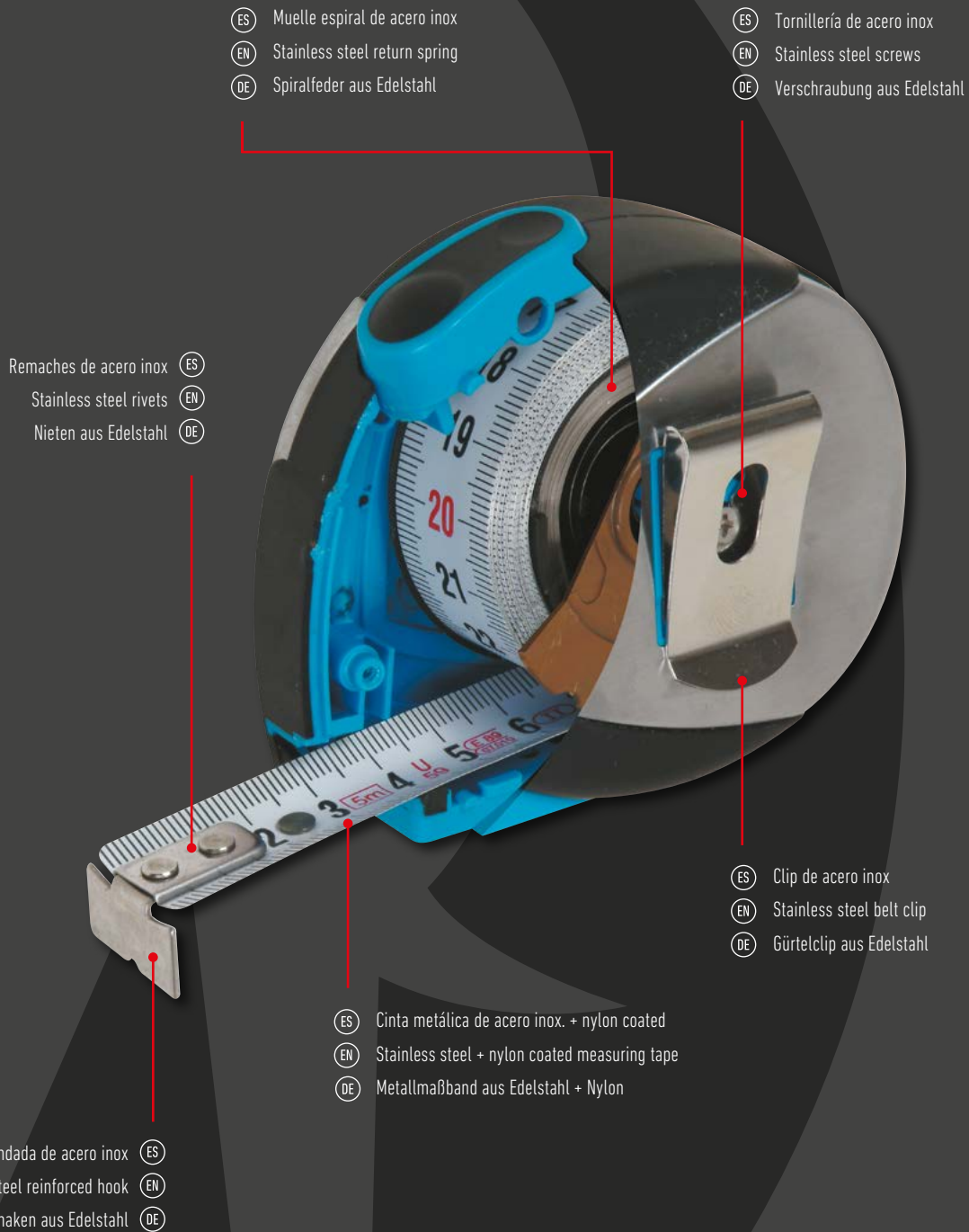

- ES Muelle espiral de acero inox
- EN Stainless steel return spring
- DE Spiralfeder aus Edelstahl

- ES Tornillería de acero inox
- EN Stainless steel screws
- DE Verschraubung aus Edelstahl

- ES Remaches de acero inox
- EN Stainless steel rivets
- DE Nieten aus Edelstahl

- ES Clip de acero inox
- EN Stainless steel belt clip
- DE Gürtelclip aus Edelstahl

- ES Cinta metálica de acero inox. + nylon coated
- EN Stainless steel + nylon coated measuring tape
- DE Metallmaßband aus Edelstahl + Nylon

- ES Uña blindada de acero inox
- EN Stainless steel reinforced hook
- DE Endhaken aus Edelstahl

ES La cinta tiene aproximadamente el 0,6 % de Níquel y el muelle un 6 % (un imán no atrae aleaciones con composición superior al 8 % de Níquel).  
 EN The blade as approximately 0,6 % of Nickel and the resort 6 % (a magnet does not attract alloys with a composition higher than 8 % of Nickel).  
 DE Das Maßband besteht aus ca. 0,6 % Nickel und die Feder aus ca. 6 % (ein Magnet zieht keine Legierungen mit einer Zusammensetzung von über 8 % Nickel an).

# UÑA BLINDADA / REINFORCED HOOK / VERSTÄRKTER ENDHAKEN

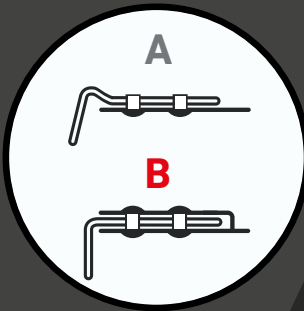

**A** - NORMAL / NORMAL / NORMAL

**B** - BLINDADA / REINFORCED / VERSTÄRKT

- ES Más resistencia = mayor duración = más precisión.
- EN More resistance = longlasting = more accuracy.
- DE Robuster = längere Haltbarkeit = höhere Genauigkeit

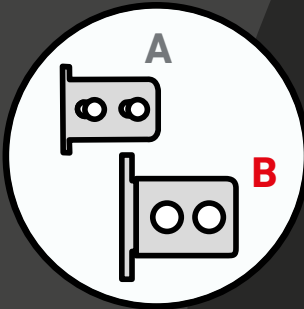

- ES Mayor suavidad de desplazamiento. Remaches de mayor grosor.
- EN Slippery sliding. Bigger rivets.
- DE Extrem leichtgleitend. Dickere Nieten.

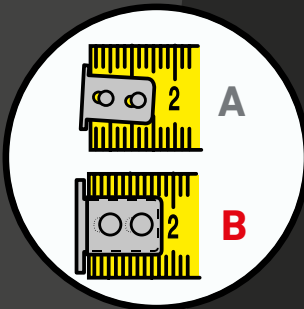

- ES Más exactitud en mediciones por el mejor guiado de la uña.
- EN Granted accuracy due to the better guidance of the hook.
- DE Höhere Messgenauigkeit durch die bessere Führung des Endhakens.

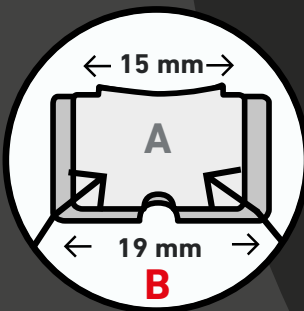

- ES Mejor agarre por su mayor anchura.
- EN Better holding thanks to the enlarged wideness.
- DE Besserer Halt durch größere Breite.



- ES La uña deslizable de los flexómetros garantiza el **punto "0"** tanto en mediciones exteriores como interiores.
- EN The sliding hook guarantee always the **"true zero"** inside or outside measurements.
- DE Der gleitende Endhaken der Rollbandmaße garantiert immer den **Nullpunkt**, sowohl bei Außen- als auch Innenmessungen.

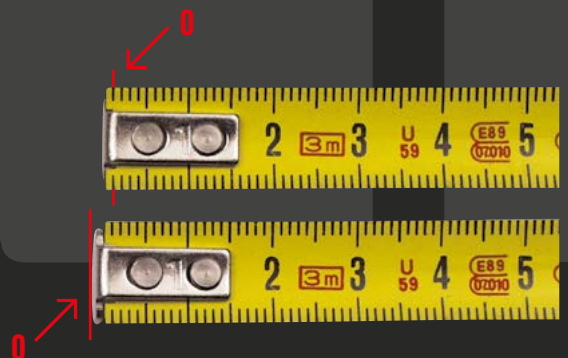



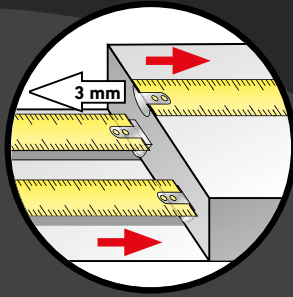
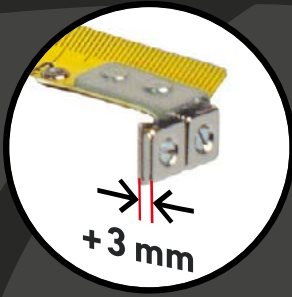

- ES El movimiento de la uña ha sido ajustado al grosor para garantizar la medición exacta.
- EN The sliding hook has been adapted at the thickness to grant the true zero.
- DE Die Bewegung des Endhakens ist seiner Dicke angepasst, um eine genaue Messung zu garantieren.



MEDIO



OTROS  
OTHERS  
ANDERE



- ES Con una resistencia a un peso de **2,5 kg**, nuestras uñas aguantan 5 veces más que la media de las uñas existentes en el mercado.
- EN With a resistance up to **2,5 kg**, our hook hold's 5 times more than the average of the hook's available in the market.
- DE Mit einer Haltekraft von **2,5 kg** halten unsere Endhaken 5 Mal mehr aus, als der Durchschnitt der auf dem Markt erhältlichen Endhaken.

## IMPRESIÓN DOS CARAS / BOTH SIDES PRINTED / ZWEISEITIG BEDRUCKT

- ES REVERSO: escala vertical.
- EN BACK: vertical scale.
- DE VORDERSEITE: vertikale Skala

- ES ANVERSO: escala horizontal.
- EN FRONT: horizontal scale.
- DE RÜCKSEITE: horizontale Skala

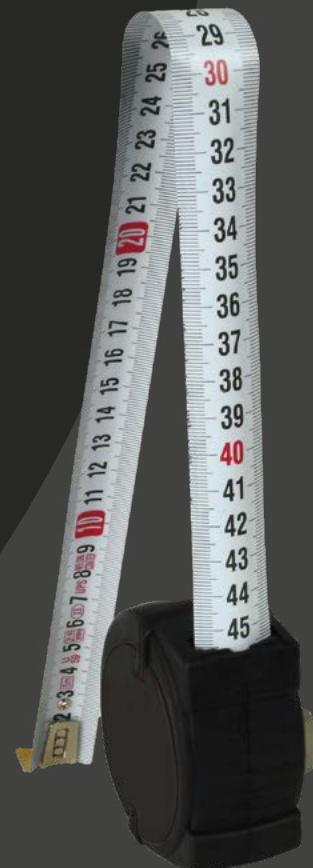

# CINTAS UPS® / UPS® TAPES / UPS® MASSBÄNDER

- ES** Las cintas UPS®, desarrolladas mediante tecnología y procesos exclusivos de MEDID, duran 10 veces más que las cintas normales. TEST JIS: UPS® resiste más de 500 ciclos, frente a los 240 ciclos del competidor más cercano, y los entre 15 y 70 ciclos de resistencia de la mayoría de marcas de todo el mundo.
- EN** UPS® tape, produced with machinery engineering entirely developed and patented by MEDID, it's 10 times more resistant than normal ones. TEST JIS: UPS®-MEDID tapes resist 500 cycles against the 240 of the best placed concurrent, and the 15 to 70 of the majority of brands.
- DE** Die mit exklusiver MEDID-Technologie und -Prozessen entwickelten UPS®-Maßbänder haben eine 10 Mal höhere Lebensdauer als übliche Maßbänder. JIS-TEST: Während UPS®-Bänder über 500 Zyklen standhalten, kommen die besten Wettbewerber nur auf 240 Zyklen und die Mehrzahl der weltweit vorhanden Marken lediglich auf 15 bis 70 Zyklen.

## UPS + NYLON COATED

- ES** Esmalte opaco, polimerizado a alta temperatura

**EN** Opaque enamel, polymerized at high temperature

**DE** Bei hoher Temperatur polymerisiertes opakes Email
- ES** Recubrimiento de Nylon

**EN** Nylon coating

**DE** Nylon-Beschichtung
- ES** Base de acero extrafino templado

**EN** Tempered steel base

**DE** Extradünne gehärtete Stahlunterlage
- ES** Tratamiento de anclaje

**EN** Surface anchoring treatment

**DE** Oberflächenbehandlung für höhere Haftung
- ES** Esmalte transparente bicapa, mediante deposición por tecnología UPS®

**EN** Two coatings transparent enamel (UPS® technology deposition)

**DE** Transparente Zweischichten-Emallierung mittels UPS®-Auftragsverfahren

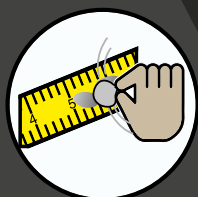

- ES** Antiadherentes
- EN** Antiadherent
- DE** Antiadhäsiv



- ES** Mejor deslizamiento
- EN** Slippery coating
- DE** Besseres Gleitverhalten



- ES** Mayor duración
- EN** Long life
- DE** Längere Haltbarkeit



- ES** Antireflectantes
- EN** Non-reflective
- DE** Antireflexiv

# CINTAS MÉTRICAS / LONG TAPES / MABBAND

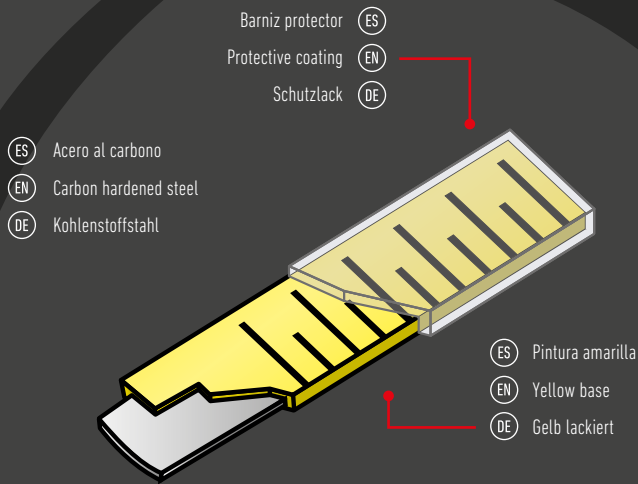

## (ES) CINTAS MÉTRICAS METÁLICAS

De acero templado, milimetradas. Las cintas metálicas se aconsejan para la medición profesional y muy exacta de distancias. PRECISIÓN CLASE II (Homologación CEE) de menor tolerancia, es decir MAYOR PRECISIÓN.

## (EN) STEEL LONG TAPES

Tempered steel tape, 1 mm scale interval. Steel long tapes are suitable for professional measurements with ACCURACY CLASS II (EEC approval), less tolerance means HIGHER ACCURACY.

## (DE) METALL-MASSBÄNDER

Aus gehärtetem Stahl, Millimeterskala. Metall-Maßbänder eignen sich für professionelle und präzise Längenmessungen. GENAUIGKEITSKLASSE II (EG-Typgenehmigung) mit engerer Toleranz, also MEHR PRÄZISION.

## (ES) CINTAS MÉTRICAS DE FIBRA DE VIDRIO

Recomendables para la medición de largas distancias por su menor peso, flexibilidad y duración; por ser lavables, no conductoras de la electricidad y resistentes a la abrasión y tensión.

## (EN) FIBER GLASS TAPES

Comfortable to use in long distances measurement due to the light weight, flexibility and longlasting. Washables, non conducting and resistant to abrasion and tension.

## (DE) GLASFASER-MASSBÄNDER

Empfohlen für die Messung langer Distanzen aufgrund ihres geringen Gewichts, ihrer Flexibilität und Haltbarkeit, dadurch, dass sie waschbar und elektrisch nicht leitend sowie abrieb- und zugfest sind.

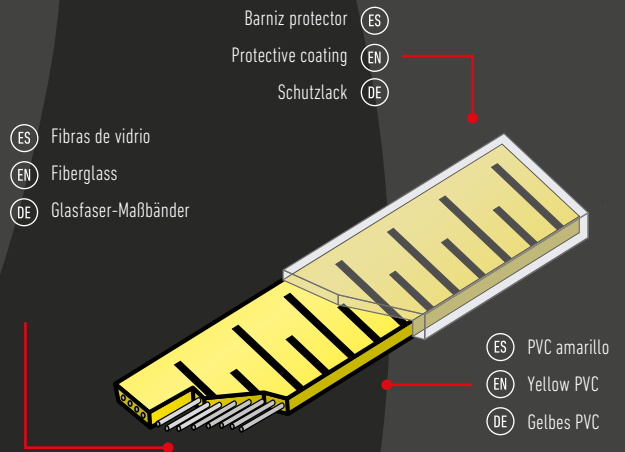

Fibra de Vidrio en **CLASE II = DOBLE PRECISIÓN** / Fiberglass in **CLASS II = DOUBLE ACCURACY** / Glasfaser in **KLASSE II = DOPPELTE GENAUIGKEIT**

PRECISIÓN ACCURACY GENAUIGKEIT	LONGITUD / TOLERANCIA LENGHT / TOLERANCE LÄNGE / TOLERANZ (±mm)									
	1 m	2 m	3 m	5 m	8 m	10 m	20 m	30 m	50 m	100 m
CLASE II	0,5	0,7	0,9	1,3	1,9	2,3	4,3	6,3	10,3	20,3
CLASE III	1,0	1,4	1,8	2,6	3,8	4,6	8,6	12,6	20,6	40,6

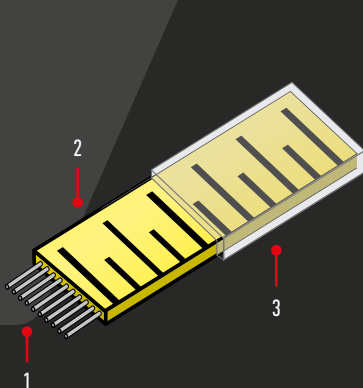

Muy resistente al desgaste. Ligero.  
 Flexible. Lavable. No conductor eléctrico en seco.

1 Parallel strands of fiberglass.  
 2 Plastic coating.  
 3 Transparent coating protects blade graphics.  
 Highly resistant to mechanical and chemical abrasion.  
 Lightweight. Pliable. Virtually stretch-free. Washable.  
 Electrically non-conductive.

1 Parallele Glasfasern.  
 2 Kunststoffbeschichtung.  
 3 Klarlackbeschichtung zum Schutz der Markierung.  
 Extrem verschleißfest. Leicht. Flexibel. Waschbar. Elektrisch nicht leitend im trockenem Zustand.

# FLEXÓMETROS UPS CLASE I + INOX

CLASS I UPS MEASURING TAPES

ROLLBANDMAßE UPS KLASSE I + EDELSTAHL



## FLEXÓMETRO UPS CLASE I



REF.	m			REF.		
43191	3	19 mm	Inox + Elastollan	10	8421411015247	
45191	5	19 mm	Inox + Elastollan	10	8421411015254	
45251	5	25 mm	Inox + Elastollan	10	8421411015261	



- ES** Flexómetro con mayor precisión del mercado. Estuche ergonómico, realizado en acero inoxidable y Elastollan, grabado con láser y de alta resistencia, con clip de cintura. Botón de freno antideslizante. Uña blindada fijada con 3 remaches.
- EN** The most precise tape measure on the market. Ergonomic case made of stainless steel and Elastollan, laser-engraved and highly resistant, with a waist clip. Non-slip brake button. Shielded hook secured with 3 rivets.
- DE** Rollbandmaß mit höchster Präzision auf dem Markt. Ergonomisches Gehäuse aus Edelstahl und Elastollan, lasergraviert und extrem griffig, mit Gürtelclip, Bremstaste sowie verstärktem, mit 3 Nieten befestigtem Endhaken.

### LONGITUD/TOLERANCIA LENGHT/TOLERANCE LÄNGE/TOLERANZ (±mm)

PRECISIÓN ACCURACY GENAUIGKEIT

CLASE I = 0,1 + 0,1 L

1 m	2 m	3 m	5 m	8 m	10 m	20 m	30 m	50 m	100 m
0,2	0,3	0,4	0,6	0,9	1,1	2,1	3,1	5,1	10,1

## FLEXÓMETRO PROTECTOR INOX



REF.	m			REF.		
43195	3	19 mm	Inox + Elastollan	10	8421411020265	
45195	5	19 mm	Inox + Elastollan	10	8421411020272	
45255	5	25 mm	Inox + Elastollan	10	8421411015308	



- ES** Flexómetro totalmente inoxidable con estuche muy robusto de acero inoxidable y Elastollan. Grabado con láser. Con freno y pausa inferior. Uña blindada. Impreso en ambas caras.
- EN** Fully stainless steel tape measure with a highly durable ABS, stainless steel and Elastollan case. Laser-engraved. With an inferior brake and pause. Shielded hook. Printed on both sides.
- DE** Komplett rostfreies Rollbandmaß mit äußerst robustem Gehäuse aus Edelstahl und Elastollan. Lasergraviert. Mit unterer Bremse und Pause. Verstärkter Endhaken. Beidseitig bedruckt.



# FLEXÓMETROS INOX + NO CONDUCTIVO + NYLON COATED

INOX + NON-CONDUCTIVE + NYLON COATED MEASURING TAPES

ROLLBANDMAß EDELSTAHL + NICHT LEITEND + NYLONBESCHICHTET



## FLEXÓMETRO ELEPHANT BIMATERIAL INOX

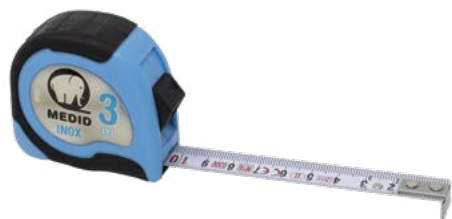

REF.	m				
9163	3	16 mm	ABS + Elastollan	10	8421411021514
9195	5	19 mm	ABS + Elastollan	10	8421411021521



- ES Flexómetro totalmente resistente al agua. Con estuche bimaterial ABS y Elastollan. Equipado con freno de goma y clip para cinturón. Botón de freno con acabado en goma antideslizante.
- EN Waterproof tape measure. Featuring a bimaterial ABS and Elastollan case. Equipped with a rubber brake and a belt clip. Non-slip rubber-coated stop button.
- DE Wasserdichtes Rollbandmaß. Mit einem 2K-Gehäuse aus ABS und Elastollan. Ausgestattet mit einer Bandbremse aus Gummi und einem Gürtelclip. Die Bremsaste ist mit einem griffigen Gummi beschichtet.

## FLEXÓMETRO NO CONDUCTIVO



REF.	m				
1935	3,5 m	19 mm	Fibra de Kevlar	1	4954771200014



- ES Cinta métrica producida con hilos de fibra de vidrio recubiertos de Fibra de Kevlar (marca registrada de Dupont), que garantiza la rigidez de la cinta. Cinta amarilla, milimétrica, impresa una cara, con uña de plástico ABS. Estuche realizado en plástico ABS con freno y clip. Prueba de resistencia del aislamiento 1.000 V. Precisión 1st grade 0-4 m: ±0,8 mm. Homologación \*JIS (Japan Industry Standard).
- EN Tape produced with fiberglass threads covered with Kevlar Fiber (Dupont registered trademark), which guarantees the rigidity of the tape. Yellow, millimetric tape, printed on one side, with ABS plastic nail. Case made of ABS plastic with stop and belt clip. Insulation resistance test 1,000 V. 1st grade accuracy 0-4 m: ±0.8 mm. \*JIS (Japan Industry Standard) approval.
- DE Rollbandmaß aus Glasfaser mit Kevlar-Beschichtung (eingetragene Marke von Dupont), das die Steifigkeit des Bandes gewährleistet. Gelbes Band mit Millimeterskala, einseitig bedruckt, mit ABS-Endhaken. Gehäuse aus ABS mit Bandbremse und Gürtelclip. Isolationsprüfung mit 1.000 V. Genauigkeitsklasse 1: 0-4 m: ±0,8 mm. Zulassung nach \*JIS (Japan Industry Standard).

## FLEXÓMETRO MAXI PRO



REF.	m				
3205	5	32 mm	ABS + Elastollan	6	8421411024454
3208	8	32 mm	ABS + Elastollan	6	8421411024461



- ES Flexómetro Heavy Duty. Con doble uña especial antideslizante imantada. Cinta con tratamiento de nylon aplicado por extrusión impresa a doble cara. Con estuche de gran resistencia a los impactos, probado con el Drop performance testing, hasta los 3 metros.
- EN Heavy Duty tape measure. With double special non-slip magnetic hook. Tape with nylon treatment applied by extrusion, printed on both sides. Comes with a high-impact-resistant case, tested with Drop performance testing up to 3 meters.
- DE Robustes Heavy-Duty-Rollbandmaß. Mit speziellem, rutschfesten magnetischen Doppel-Endhaken. Band mit extrusionsbeschichtetem Nylon, beidseitig bedruckt. Mit stoßfestem Gehäuse, das gemäß Sturztest aus einer Fallhöhe von 3 Meter getestet wurde.

# FLEXÓMETROS UPS + NYLON COATED

UPS MEASURING TAPES + NYLON COATED

ROLLBANDMAßE UPS + NYLONBESCHICHTET

## FLEXÓMETRO UPS PREMIUM



**NUEVO  
DISEÑO**

REF.	m				
25351	3	19 mm	ABS Cromado	5	8421411010105
25537	5	27 mm	ABS Cromado	5	8421411010136
25541	8	27 mm	ABS Cromado	5	8421411010143
25550	10	27 mm	ABS Cromado	5	8421411010150



- ES Flexómetro UPS Premium. Doble freno. Una blindada. Cinta tratada con UPS Nylon que garantiza alta resistencia. En amarillo, con graduación milimétrica en la cara, blanco en la parte posterior. Estuche ABS cromado.
- EN UPS Premium tape measure. Double brakes. Shielded hook. Tape treated with UPS Nylon for high durability. In yellow, with millimeter graduation on the face. Chrome-plated ABS case.
- DE UPS Premium Rollbandmaß. Doppel-Bandbremse. Vestärkter Endhaken. Mit UPS Nylon beschichtetes Band für hohe Beständigkeit. In Gelb mit Millimeterskala auf der Vorderseite und in Weiß auf der Rückseite. Verchromtes ABS-Gehäuse.

## FLEXÓMETRO UPS



REF.	m				
60003	3	16 mm	ABS	25	8421411005576



- ES Flexómetro con cinta métrica retráctil. Estuche ABS y cinta UPS Nylon de alta protección contra la abrasión y duración hasta 10 veces superior. Con freno y clip de cintura.
- EN Retractable tape measure with metric tape. ABS case and high-abrasion-resistant UPS Nylon tape with up to 10 times longer durability. Equipped with a brake and a waist clip.
- DE Maßband mit einziehbarer metrischer Messung. ABS-Gehäuse und UPS Nylon-Band für hervorragenden Schutz gegen Abrieb und bis zu 10-mal längere Lebensdauer. Mit Bremse und Gürtelclip.

## FLEXÓMETRO UPS ESPECIAL PARA ZURDOS



REF.	m				
60003Z	3	16 mm	ABS	15	8421411014509
60005Z	5	19 mm	ABS	10	8421411014516



- ES Flexómetro especial para zurdos. La impresión inversa de la graduación permite su lectura de forma clara a los usuarios zurdos. Estuche ABS y cinta UPS Nylon de alta protección contra la abrasión y duración hasta 10 veces superior. Con freno y clip de cintura.
- EN Left-handed tape measure. Reverse graduation printing allows clear reading for left-handed users. ABS case and high-abrasion-resistant UPS Nylon tape with up to 10 times longer durability. Equipped with a brake and a waist clip.
- DE Spezielles Rollbandmaß für Linkshänder. Die umgekehrte Skala ermöglicht eine klare Ablesbarkeit für linkshändige Benutzer. Mit ABS-Gehäuse und abriebfestem UPS Nylon-Band mit einer bis zu 10 Mal längeren Lebensdauer. Mit Bandbremse und Gürtelclip.

# FLEXÓMETROS MODELO ELEPHANT

ELEPHANT MEASURING TAPES

ROLLBANDMAß MODELL ELEPHANT



FLEXÓMETRO ELEPHANT BIMATERIAL	REF.	m				
 <b>NUEVO DISEÑO</b>	8163	3	16 mm	ABS + Elastollan	25	8421411010921
	8193	3	19 mm	ABS + Elastollan	10	8421411023969
	8195	5	19 mm	ABS + Elastollan	10	8421411010938
	8255	5	25 mm	ABS + Elastollan	10	8421411011430
	8308	8	30 mm	ABS + Elastollan	10	8421411010945
	8162MP	2	16 mm	ABS + Elastollan	25	8421411011720
	8163MP	3	16 mm	ABS + Elastollan	25	8421411011737
	8255MP	5	25 mm	ABS + Elastollan	10	8421411011744
	8308MP	8	30 mm	ABS + Elastollan	10	8421411010945

nylon coated	Uña blindada	

	Flexómetro bimaterial. Estuche ABS, recubierto de Elastollan de alta resistencia y antideslizante. Con freno y clip de cintura. Uña blindada. Cinta Nylon de alta protección contra la abrasión y duración hasta 10 veces superior. Versión en mm y versión en mm + pulgadas.
	Bimaterial tape measure. ABS case, coated with high-resistance and non-slip Elastollan. Equipped with a brake and waist clip. Reinforced hook. High protection Nylon tape against abrasion with a durability up to 10 times superior. Version in mm and mm + inches.
	Rollbandmaß mit widerstandsfähigem und griffigem Elastollan beschichtetem ABS-Gehäuse. Mit Bandbremse und Gürtelclip. Verstärkter Endhaken. Widerstandsfähiges Nylonband mit bis zu 10-fach langer Lebensdauer. Ausführung mit Millimeterskala sowie Millimeter- und Zollskala.

FLEXÓMETRO ELEPHANT SIN FRENO	REF.	m				
	6133	3	13 mm	ABS	25	8421411009086

Uña blindada

	Flexómetro sin freno. Estuche ABS y de alta resistencia. Uña blindada ancha y con remaches más gruesos para una mayor resistencia y duración. Con refuerzo inferior, fijado con 3 remaches.
	Tape measure without brake. High-strength ABS case. Wide reinforced blade tip with thicker rivets for greater strength and durability. With lower reinforcement, secured with 3 rivets.
	Rollbandmaß ohne Bandbremse. Hochfestes Gehäuse aus ABS. Breiter verstärkter Endhaken mit dickeren Nieten für mehr Widerstandsfähigkeit und Langlebigkeit. Mit unterer, durch 3 Nieten befestigter Verstärkung.

FLEXÓMETRO ELEPHANT MAGNÉTICO	REF.	m				
	8193M	3	19 mm	ABS+Elastollan	10	8421411023976
	8195M	5	19 mm	ABS+Elastollan	10	8421411023983

	nylon coated	Uña blindada		

	Flexómetro con uña magnética. Estuche ABS, recubierto de Elastollan de alta resistencia y antideslizante. Con 2 imanes en la uña que aguantan una tensión de 2,5 kg. Con freno y clip de cintura.
	Magnetic tape measure. ABS case, coated with highly resistant and non-slip Elastollan. With 2 magnets on the hook that hold 2,5 kg. Equipped with a brake and belt clip.
	Rollbandmaß mit magnetischem Endhaken. Mit widerstandsfähigem und griffigem Elastollan beschichtetem ABS-Gehäuse. Die beiden Magnete am Endhaken widerstehen einer Zugkraft von bis zu 2,5 kg. Mit Bandbremse und Gürtelclip.

+3 mm	2,5 kg

# FLEXÓMETROS ALTA VISIBILIDAD

HIGH VISIBILITY MEASURING TAPES

ROLLBANDMAß MIT HOHER SICHTBARKEIT

## FLEXÓMETRO TRIPLE BLACK





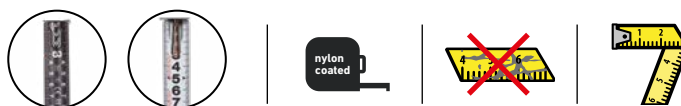

REF.	m				
7163	3	16 mm	ABS + Elastollan	10	8421411008393
7255	5	25 mm	ABS + Elastollan	10	8421411008348
7258	8	25 mm	ABS + Elastollan	10	8421411008355



- (ES) Flexómetro de alta visibilidad con estuche de diseño ergonómico, recubierto de Elastollan antideslizante. Cinta impresa en ambas caras recubierta de Nylon. La cara posterior en vertical para la medición de alturas. Botón de freno con acabado antideslizante. Equipado con muñequera textil y clip de cintura. Uña blindada con 3 remaches para una mayor resistencia y duración.
- (EN) High-visibility tape measure with an ergonomically designed case, coated with non-slip Elastollan. The tape is printed on both sides and covered with Nylon. The back side is marked vertically for height measurement. Brake button with non-slip finish. Equipped with a textile wrist strap and a waist clip. Reinforced blade tip with 3 rivets for increased strength and durability.
- (DE) Rollbandmaß mit guter Ablesbarkeit und ergonomischem, mit griffigem Elastollan beschichteten Gehäuse. Das Maßband ist beidseitig bedruckt und mit Nylon beschichtet. Die Skala auf der Rückseite ist vertikal für Höhenmessungen. Die Bremstaste ist gummiert. Das Rollbandmaß ist mit einer Textil-Handschnalle und einem Gürtelclip ausgestattet. Der verstärkte Haken ist mittels 3 Nieten für mehr Festigkeit und Langlebigkeit befestigt.

## FLEXÓMETRO BLACK&GREEN







REF.	m				
7528	5	28 mm	ABS + Elastollan	10	8421411025024
7828	8	28 mm	ABS + Elastollan	6	8421411025031



- (ES) Flexómetro bimaterial de alta visibilidad. Fabricado en ABS y recubierto de caucho. Graduación milimétrica con cinta negra impresa en ambos lados en verde. Con freno, clip de cintura y mosquetón.
- (EN) High-visibility bimaterial tape measure. Made of ABS and coated with rubber. Millimeter graduation with black tape printed on both sides in green. With brake, waist clip, and carabiner.
- (DE) Rollbandmaß mit 2K-Gehäuse und guter Ablesbarkeit. Hergestellt aus gummibeschichtetem ABS. Schwarzes, beidseitig grün bedrucktes Maßband mit Millimeterskala. Mit Bandbremse, Gürtelclip und Karabinerhaken.

## FLEXÓMETRO BLACK&WHITE



REF.	m				
6319	3	19 mm	ABS	12	8421411024478
6522	5	22 mm	ABS	12	8421411024485
6528	5	28 mm	ABS	12	8421411024492
6828	8	28 mm	ABS	6	8421411024508



- (ES) Flexómetro de alta visibilidad. ABS bicolor. Con freno. Con clip y mosquetón. Cinta de color blanco con impresión a doble cara. Graduación milimétrica.
- (EN) High-visibility tape measure. Two-tone ABS. With brake. With clip and carabiner. White tape with double-sided printing. Millimeter graduation.
- (DE) Maßband mit hoher Sichtbarkeit. Zweifarbiges ABS-Gehäuse. Mit Bremse, Clip und Karabinerhaken. Weiße Bandfarbe mit beidseitigem Druck und millimetergenauer Graduierung.



# FLEXÓMETROS CON FUNDA DE GOMA

MEASURING TAPES WITH RUBBER COVER

ROLLBANDMAßE MIT GUMMISCHUTZ



FLEXÓMETRO AUTOLOCK	REF.	m				
	99193	3	16 mm	ABS + Goma	15	8421411016862
	99255	5	25 mm	ABS + Goma	12	8421411016879
	99308	8	30 mm	ABS + Goma	8	8421411016886



- (ES) Flexómetro anti golpes con auto-freno. Estuche de diseño ergonómico, realizado en ABS y recubierto de goma de alta resistencia. Con clip de cintura y muñequera textil.
- (EN) Shock-resistant tape measure with automatic brake. Ergonomically designed case made of high-strength ABS and rubber coating. With waist clip and textile wrist strap.
- (DE) Stoßfestes Maßband mit automatischem Bremssystem. Ergonomisches Gehäuse aus ABS, beschichtet mit hochfestem Gummi. Mit Gürtelclip und textiler Handschlaufe.

FLEXÓMETRO SOFT	REF.	m				
	70003	3	19 mm	ABS + Goma	10	8421411021682
	70005	5	25 mm	ABS + Goma	10	8421411021422
	70008	8	25 mm	ABS + Goma	10	8421411021439

- (ES) Flexómetro soft con estuche bimaterial antideslizante. Estuche de diseño ergonómico, realizado en ABS y recubierto de goma de alta resistencia. Con freno y clip de cintura.
- (EN) Soft tape measure with non-slip bimaterial case. Ergonomically designed case made of high-strength ABS and rubber coating. With brake and waist clip.
- (DE) Flexibles Maßband mit rutschfestem Bimaterial-Gehäuse. Ergonomisches Gehäuse aus ABS, beschichtet mit hochfestem Gummi. Mit Bremse und Gürtelclip.

FLEXÓMETRO XXL	REF.	m				
	9253	3	25 mm	ABS + Goma	5	8421411018170
	9256	6	25 mm	ABS + Goma	5	8421411018187
	9310	10	25 mm	ABS + Goma	5	8421411018194



- (ES) Flexómetro con funda de goma "talla grande XXL". Estuche de diseño ergonómico, realizado en ABS y recubierto de goma de alta resistencia. Con freno y clip de cintura.
- (EN) Tape measure with XXL-size rubber case. Ergonomically designed case made of high-strength ABS and rubber coating. With brake and waist clip.
- (DE) Maßband mit "XXL"-Gummihülle. Ergonomisches Gehäuse aus ABS, beschichtet mit hochfestem Gummi. Mit Bremse und Gürtelclip.

# FLEXÓMETRO ERGO + STAR CROMADOS

ERGO + STAR CHROMED MEASURING TAPES

ERGO + STAR VERCHROMTES ROLLBANDMAß

## FLEXÓMETRO ERGO MAGNÉTICO



**NUEVO DISEÑO**

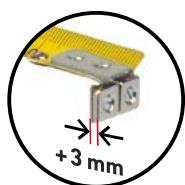

REF.	m				
3419M	3	19 mm	ABS + Goma	10	8421411013922
5419M	5	19 mm	ABS + Goma	10	8421411013939
8425M	8	25 mm	ABS + Goma	10	8421411013946
3419MMP	3	19 mm	ABS + Goma	10	8421411016831
5419MMP	5	19 mm	ABS + Goma	10	8421411016848
8425MMP	8	25 mm	ABS + Goma	10	8421411016855



- (ES) Flexómetro magnético. Estuche de diseño ergonómico, realizado en ABS y recubierto de goma de alta resistencia. Uña con 2 imanes que aguantan una tensión de 2,5 kg, fijada con 3 remaches gruesos para una mayor resistencia y duración. Versión en mm y versión en mm + pulgadas.
- (EN) Magnetic tape measure. Ergonomically designed case made of high-strength ABS and coated with rubber. With 2 magnets on the hook that hold 2,5 kg, secured with 3 thick rivets for increased strength and durability. Version in mm and mm + inches.
- (DE) Magnetisches Rollbandmaß mit ergonomischem Gehäuse aus mit widerstandsfähigem Gummi beschichtetem ABS. Mit 2 Magneten ausgestatteter Endhaken, die einer Zugkraft von bis zu 2,5 kg widerstehen und mit 3 dicken Nieten für mehr Festigkeit und Langlebigkeit befestigt sind. Ausführung mit Millimeterskala sowie Millimeter- und Zollskala.

## FLEXÓMETRO STAR CROMADO



REF.	m				
CL-1219	2	19 mm	Cromado	25	8421411010907
CL-1313	3	13 mm	Cromado	25	8421411010846
CL-1319	3	19 mm	Cromado	25	8421411010860
CL-1519	5	19 mm	Cromado	10	8421411010877
CL-1525	5	25 mm	Cromado	10	8421411010884
CL-1025	10	25 mm	Cromado	10	8421411010815
CL-1825	8	25 mm	Cromado	10	8421411010891



- (ES) Flexómetro de la gama Star con estuche ABS cromado. Cinta recubierta de nylon, de alta resistencia. Con freno y clip de cintura.
- (EN) Tape measure from the Star series with a chrome-plated ABS case. High-strength nylon-coated tape. With brake and waist clip.
- (DE) Rollbandmaß der Serie Star mit verchromtem ABS-Gehäuse. Die Maßband ist mit widerstandsfähigem Nylon beschichtet. Mit Bandbremse und Gürtelclip.

## FLEXÓMETRO STAR SIN FRENO



REF.	m				
CL-1313SF	3	13 mm	Cromado	25	8421411010839



- (ES) Flexómetro de la gama Star con estuche ABS cromado. Sin freno.
- (EN) Star series tape measure with chrome-plated ABS case. Without brake.
- (DE) Rollbandmaß der Serie Star mit verchromtem ABS-Gehäuse. Ohne Bandbremse.

# FLEXÓMETROS STAR ABS

STAR LINE MEASURING TAPES. ABS CASING

ROLLBANDMAß STAR ABS



## FLEXÓMETRO STAR BIMATERIAL



REF.	m				
<b>B316</b>	3	16 mm	ABS + Elastollan	15	8421411012123
<b>B519</b>	5	19 mm	ABS + Elastollan	10	8421411013168
<b>B525</b>	5	25 mm	ABS + Elastollan	10	8421411012130
<b>B825</b>	8	25 mm	ABS + Elastollan	10	8421411012147

- (ES) Flexómetro de la gama Star con estuche bimaterial, compuesto de ABS y Elastollan de alta resistencia. Con freno y clip de cintura.
- (EN) Star series tape measure with a bimaterial case made of high-strength ABS and Elastollan. With brake and waist clip.
- (DE) Rollbandmaß der Serie Star mit 2K-Gehäuse aus ABS und hochfestem Elastollan. Mit Bandbremse und Gürtelclip.

## FLEXÓMETRO STAR BIMATERIAL MAGNÉTICO



REF.	m				
<b>B316M</b>	3	16 mm	ABS + Elastollan	15	8421411023105
<b>B519M</b>	5	19 mm	ABS + Elastollan	10	8421411018903
<b>B525M</b>	5	25 mm	ABS + Elastollan	10	8421411023006
<b>B825M</b>	8	25 mm	ABS + Elastollan	10	8421411023013

- (ES) Flexómetro de la gama Star con estuche bimaterial, compuesto de ABS y Elastollan de alta resistencia. Con freno y clip de cintura.
- (EN) Star series tape measure with a bimaterial case made of high-strength ABS and Elastollan. With brake and waist clip.
- (DE) Rollbandmaß der Serie Star mit 2K-Gehäuse und magnetischem Endhaken. Das Gehäuse besteht aus ABS und hochfestem Elastollan. Mit Bandbremse und Gürtelclip.

## FLEXÓMETRO COMPACTO



REF.	m				
<b>9013</b>	3	13 mm	ABS	25	8421411005958

- (ES) Flexómetro de la gama Star súper compacto. Estuche de diseño ergonómico de ABS de alta resistencia. Con freno y clip de cintura.
- (EN) Super compact Star series tape measure. Ergonomically designed case made of high-strength ABS. With brake and waist clip.
- (DE) Superkompaktes Rollbandmaß der Serie Star. Ergonomisches Gehäuse aus hochfestem ABS. Mit Bandbremse und Gürtelclip.

# FLEXÓMETROS ESPECIALES

SPECIAL MEASURING TAPES

SPEZIELLE ROLLBANDMAßE

## FLEXÓMETRO DE INTERIORES

REF.

m



5417

3

16 mm

ABS

10

8421411006252



- (ES) Flexómetro especial con mirilla superior para la medición directa de interiores. Estuche de diseño ergonómico de ABS de alta resistencia. Con freno de pulsante lateral y clip de cintura.
- (EN) Tape measure with special top viewport for direct interior measurement. Ergonomically designed case made of high-strength ABS. With side push-button brake and waist clip.
- (DE) Spezielles Rollbandmaß mit oberer Sichtöffnung für direkte Innenmessungen. Ergonomisches Gehäuse aus hochfestem ABS. Mit seitlicher Bremsaste und Gürtelclip.

## FLEXÓMETRO MEDIDOR DE DIÁMETROS

REF.

m



5393

3

7 mm

ABS + Aluminio

10

8421411013755



- (ES) Flexómetro medidor de diámetros extraplano compuesto de ABS y Aluminio. Por la cara superior realiza mediciones convencionales, en la cara posterior de la cinta se realiza la conversión a la medida del diámetro del elemento medido.
- (EN) Extra-thin diameter measuring tape made of ABS and aluminum. It performs conventional measurements on the top side, and on the back of the tape, it converts the measurement to the diameter of the item being measured.
- (DE) Extrem flaches Rollbandmaß zur Durchmesserermittlung, hergestellt aus ABS und Aluminium. Auf der Oberseite des Maßbandes werden herkömmliche Messungen durchgeführt und auf seiner Rückseite erfolgt die Umrechnung auf den Durchmesser des gemessenen Elements.

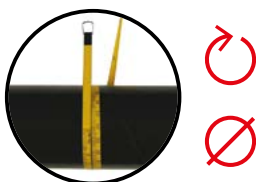

## FLEXÓMETRO BIG ELEPHANT

REF.

m



2515

15

25 mm

ABS + Elastolan

5

8421411013007



- (ES) Flexómetro Big Elephant con estuche de diseño ergonómico antideslizante compuesto de ABS y Elastolan de alta resistencia. Uña blindada con imán. Con freno y clip de cintura.
- (EN) Big Elephant tape measure with an ergonomic and non-slip design case made of high-strength ABS and Elastolan. Armored tip with magnet. With brake and waist clip.
- (DE) Big Elephant Rollbandmaß mit griffigem, ergonomischem Gehäuse aus hochfestem ABS und Elastolan. Verstärkter magnetischer Endhaken. Mit Bandbremse und Gürtelclip.



# FLEXÓMETROS ESPECIALES

SPECIAL MEASURING TAPES

SPEZIELLE ROLLBANDMAßE



FLEXÓMETROS LLAVEROS	REF.	m		Color		
	201300	2	13 mm	○	25	8421411023891
	201301	2	13 mm	●	25	8421411023907
	201303	2	13 mm	●	25	8421411023853
	201304	2	13 mm	●	25	8421411023860
	201305	2	13 mm	●	25	8421411023877
	201306	2	13 mm	●	25	8421411023884
	201325	2	13 mm	●	25	8421411023846

- ES Mini flexómetro con cinta de 2 m. Estuche bimaternal antideslizante y equipado con llavero. La cinta de 13 mm de ancho permite realizar mediciones con comodidad y precisión. Con botón de freno. Se presenta en un práctico bote transparente de 25 unidades.
- EN Mini tape measure with a 2-meter tape. Bimaterial non-slip case equipped with a keychain. The 13mm wide tape allows for comfortable and precise measurements. With a brake button. It comes in a convenient transparent jar with a screw-on lid that includes 25 units.
- DE Mini-Maßband mit 2 Meter Band, mit griffigem 2K-Gehäuse und Schlüsselanhänger. Das 13 mm breite Maßband ermöglicht bequeme und präzise Messungen. Mit Bremstaste. Lieferung und Aufbewahrung in einem praktischen transparenten Behälter mit Schraubverschluss, der 25 Rollbandmaße enthält.

FLEXÓMETRO LLAVERO	REF.	m				
	5012	1	7 mm	ABS + Goma	50	8421411003060

- ES Flexómetro llavero con estuche bimaternal ABS y goma. Con freno botón de freno.
- EN Keychain tape measure with a bimaterial ABS and rubber case. With a button brake.
- DE Rollbandmaß als Schlüsselanhänger mit 2K-Gehäuse aus ABS und Gummi. Mit Bremstaste.

FLEXÓMETRO ALUMINIO	REF.	m				
	5014	3	13 mm	Aluminio	12	8421411023402

- ES Flexómetro de aluminio de alta resistencia y con gran espacio para tener la posibilidad de añadir publicidad.
- EN High-strength aluminum tape measure with ample space for the possibility of adding advertising.
- DE Rollbandmaß aus hochfestem Aluminium mit ausreichend Platz für Werbetext.

CUELGA FLEXÓMETROS	REF.	Descripción	M. Exterior		
	990	Cuelga-flexómetros	70 x 60 mm	5	8421411013991

- ES Soporte de plástico para flexómetro con colgador: rápido y práctico.
- EN Plastic holder for tape measure with a hanger: fast and practical.
- DE Kunststoffhalterung für Rollbandmaße mit Haken: Schnell und praktisch.

# EXPOSITORES DE MOSTRADOR / COUNTER DISPLAYS / THEKEN-DISPLAYS

EXPOSITOR 4 MÓDULOS  
TÓTEM TRIPLE BLACK  
REF. TTB

74x23x19 cm



EXPOSITOR 2 MÓDULOS  
TÓTEM BLACK&WHITE  
REF. TBW

37x23x19 cm



EXPOSITOR NIVELES  
12 UDS.  
REF. 22730

38x20x13 cm



EXPOSITOR METÁLICO  
DE MOSTRADOR  
REF. 99001

50x40x28 cm



EXPOSITOR  
MEDIO PREMIUM  
REF. 84

37,5x33,5x29,5 cm





# EXPOSITORES DE SUELO / MEDIO DISPLAYS / BODEN-DISPLAYS

**EXPOSITOR LINEAL**  
1 METRO  
REF. 1001

INCLUYE:  
1 ESTANTE MODULAR  
25 GANCHOS



**EXPOSITOR METÁLICO**  
12 UDS  
REF. 99012

70x46,5x36,5 cm









# CINTAS MÉTRICAS DE FIBRA DE VIDRIO

FIBERGLASS LONG TAPES

FIBERGLAS-MAßBÄNDER

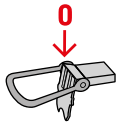

CINTAS MÉTRICAS CLASE II	REF.	m					
<b>CLASE II</b>	136020	20	15 mm	Metal + Piel	Blister	2	8421411004944
	136030	30	15 mm	Metal + Piel	Blister	2	8421411004968
	136050	50	15 mm	Metal + Piel	Blister	2	8421411004975

(ES) Cinta métrica de fibra de vidrio con gancho francés. Clase II. Graduación centimetrada. Con estuche metálico recubierto de simil piel.  
 (EN) Fiberglass tape measure with a French hook. Class II. Centimeter graduation. With a metal case covered in faux leather.  
 (DE) Glasfaser-Maßband mit Nullpunkt an vorderer Beschlagkante (Maßanfang B). Klasse II. Zentimeterskala. Mit einem Metallgehäuse, das mit Kunstleder überzogen ist.

CINTAS MÉTRICAS CLASE II	REF.	m					
<b>CLASE II</b>	166040	40	15 mm	ABS + Elastollan	Blister	1	8421411013892
	166060	60	15 mm	ABS + Elastollan	Blister	1	8421411013458
	166040 MP	40	15 mm	ABS + Elastollan	Blister	1	8421411017050
	166060 MP	60	15 mm	ABS + Elastollan	Blister	1	8421411017067





(ES) Fibra de Vidrio en CLASE II = DOBLE PRECISIÓN - Alta velocidad de retorno 3:1.  
 (EN) Fiberglass in CLASS II = DOUBLE ACCURACY - High speed return 3:1.  
 (EN) Fiberglass in KLASSE II = DOPPELTE GENAUIGKEIT - Hohe Rücklaufgeschwindigkeit 3:1.



(ES) Cinta métrica de fibra de vidrio con gancho francés. Impresa en ambas caras, con estuche abierto y recogedor de cinta reforzado. Versión en mm y versión en mm + pulgada.  
 (EN) Fiberglass tape measure with a French hook. Printed on both sides, with an open case and reinforced tape retractor. Version in mm and version in mm + inches.  
 (DE) Glasfaser-Maßband mit Nullpunkt an vorderer Beschlagkante (Maßanfang B). Beidseitig bedruckt, mit offenem Gehäuse und verstärktem Bandaufroller. Ausführung in mm sowie in mm + Zoll.

# CINTAS MÉTRICAS FIBRA DE VIDRIO

FIBERGLASS LONG TAPES

FIBERGLAS-MAßBÄNDER

## CINTA MÉTRICA FLÚOR



REF.	m					
140010	10	15 mm	ABS	Blister	1	8421411009574
140020	20	15 mm	ABS	Blister	1	8421411009598
140025	25	15 mm	ABS	Blister	1	8421411009604
140030	30	15 mm	ABS	Blister	1	8421411009611
140050	50	15 mm	ABS	Blister	1	8421411009628
140010MP	10	15 mm	ABS	Blister	1	8421411016992
140020MP	20	15 mm	ABS	Blister	1	8421411017005
140030MP	30	15 mm	ABS	Blister	1	8421411017012
140050MP	50	15 mm	ABS	Blister	1	8421411017029

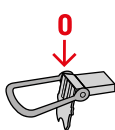

FLÚOR



- (ES) Cinta métrica de fibra fluorescente con gancho francés. Clase III. Impresa en ambas caras. Versión en mm y versión en mm + pulgadas.
- (EN) Fluorescent fiberglass tape measure with a French hook. Class III. Centimeter graduation. Printed on both sides. Version in mm and version in mm + inches.
- (DE) Fluoreszierendes Glasfaser-Maßband mit Nullpunkt an vorderer Beschlagkante (Maßbandfang B). Klasse III. Zentimeterskala auf beiden Seiten. Ausführung in mm sowie in mm + Zoll.

## CINTA MÉTRICA GRADUACIÓN MILIMÉTRICA



REF.	m					
177530N	30	15 mm	ABS	Blister	1	8421411017036
177550N	50	15 mm	ABS	Blister	1	8421411017043
1775100	100	15 mm	ABS	Blister	1	8421411007020

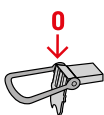

- (ES) Cinta métrica de fibra de vidrio con gancho francés. Clase III. Graduación milimétrica. Impresa en ambas caras.
- (EN) Fiberglass tape measure with a French hook. Class III. Millimeter graduation. Printed on both sides.
- (DE) Glasfaser-Maßband mit Nullpunkt an vorderer Beschlagkante (Maßbandfang B). Klasse III. Millimeterskala. Beidseitig bedruckt.

## CINTA MÉTRICA GRADUACIÓN BIMILIMETRADA



REF.	m					
197530	30	15 mm	ABS	Blister	1	8421411011829
197550	50	15 mm	ABS	Blister	1	8421411011836

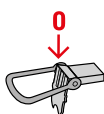

- (ES) Cinta métrica de fibra de vidrio con gancho francés. Clase III. Graduación bimilimetrada y con estuche metálico abierto. Impresa en ambas caras.
- (EN) Fiberglass tape measure with a French hook. Class III. Dual millimeter graduation and an open metal case. Printed on both sides.
- (DE) Glasfaser-Maßband mit Nullpunkt an vorderer Beschlagkante (Maßbandfang B). Klasse III. 2-Millimeter-Skala. Mit offenem Metallgehäuse und beidseitig bedruckt.

# CINTAS MÉTRICAS FIBRA DE VIDRIO

FIBERGLASS LONG TAPES

FIBERGLAS-MAßBÄNDER



CINTA MÉTRICA "0" EN ANILLA	REF.	m					
	121010	10	15 mm	ABS	Blister	1	8421411015957
	121015	15	15 mm	ABS	Blister	1	8421411015964
	121020	20	15 mm	ABS	Blister	1	8421411015971
	121025	25	15 mm	ABS	Blister	1	8421411015988
	121030	30	15 mm	ABS	Blister	1	8421411015995
	121050	50	15 mm	ABS	Blister	1	8421411016008

(ES) Cinta métrica de fibra de vidrio con el 0 en anilla. Clase III. Graduación centimetrada. Impresa en ambas caras.

(EN) Fiberglass tape measure with the 0 on the ring. Class III. Centimeter graduation. Printed on both sides.

(DE) Glasfaser-Maßband mit Maßanfang an vorderer Beschlagkante (Maßanfang B). Klasse III. Zentimeterskala. Beidseitig bedruckt.

CINTA MÉTRICA UÑA PLEGABLE	REF.	m					
	121010GF	10	15 mm	ABS	Blister	1	8421411004623
	121015GF	15	15 mm	ABS	Blister	1	8421411004630
	121020GF	20	15 mm	ABS	Blister	1	8421411004647
	121025GF	25	15 mm	ABS	Blister	1	8421411004654
	121030GF	30	15 mm	ABS	Blister	1	8421411004661
	121050GF	50	15 mm	ABS	Blister	1	8421411006238

(ES) Cinta métrica de fibra de vidrio con uña plegable. Clase III. Graduación centimetrada. Impresa en ambas caras.

(EN) Fiberglass tape measure with a folding tab. Class III. Centimeter graduation. Printed on both sides.

(DE) Glasfaser-Maßband mit klappbarem Endhaken. Klasse III. Zentimeterskala. Beidseitig bedruckt.

CINTA MÉTRICA PRINCIPIO ITALIANO	REF.	m					
	121010D	10	15 mm	ABS	Blister	1	8421411021750
	121020D	20	15 mm	ABS	Blister	1	8421411021767
	121030D	30	15 mm	ABS	Blister	1	8421411021774
	121050D	50	15 mm	ABS	Blister	1	8421411021781

(ES) Cinta métrica de fibra de vidrio con principio italiano. Clase III. Graduación centimetrada. Impresa en ambas caras.

(EN) Fiberglass tape measure with an Italian start. Class III. Centimeter graduation. Printed on both sides.

(DE) Glasfaser-Maßband mit Maßanfang einige cm hinter dem Beschlag (A). Klasse III. Zentimeterskala. Beidseitig bedruckt.

# CINTAS MÉTRICAS METÁLICAS

STEEL LONG TAPES

METALL-MAßBÄNDER

## CINTA MÉTRICA METÁLICA EN PIEL



REF.	m					
265020	20	12 mm	Metal + Piel	Blister	1	8421411005200
265030	30	12 mm	Metal + Piel	Blister	1	8421411005224
265050	50	12 mm	Metal + Piel	Blister	1	8421411005231

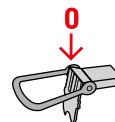

- (ES) Cinta métrica de metal con estuche recubierto de simil piel. Clase II. Graduación milimétrica. Impresa en ambas caras.
- (EN) Metal tape measure with a faux leather-covered case. Class II. Millimeter graduation. Printed on both sides.
- (DE) Metall-Maßband mit Kunstleder beschichtetem Gehäuse. Klasse II. Millimeterskala. Beidseitig bedruckt.

## CINTA MÉTRICA FAST METAL + NYLON



REF.	m					
268020	20	13 mm	Metal + Nylon	Blister	1	8421411024515
268030	30	13 mm	Metal + Nylon	Blister	1	8421411024522
268050	50	13 mm	Metal + Nylon	Blister	1	8421411024539

- (ES) Cinta métrica metálica con tratamiento de Nylon, garantizando alta resistencia al desgaste. Uña especial con gancho plegable en el punto 0. Impresa en ambas caras y recogedor de cinta reforzado.
- (EN) Metal tape measure with Nylon treatment, ensuring high wear resistance. Special tab with a folding hook at point 0. Printed on both sides and reinforced tape retractor.
- (DE) Metallmaßband mit Nylonbeschichtung, das hohe Verschleißfestigkeit gewährleistet. Spezieller klappbarer Endhaken am Nullpunkt. Beidseitig bedruckt und mit verstärktem Bandaufroller.

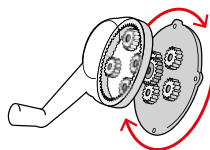

## CINTA MÉTRICA METÁLICA



REF.	m					
264020	20	13 mm	ABS + Elastollan	Blister	1	8421411005064
264030	30	15 mm	ABS + Elastollan	Blister	1	8421411005088
264050	50	16 mm	ABS + Elastollan	Blister	1	8421411005095
264010MP	10	17 mm	ABS + Elastollan	Blister	1	8421411017074
264020MP	20	18 mm	ABS + Elastollan	Blister	1	8421411017081
264030MP	30	19 mm	ABS + Elastollan	Blister	1	8421411017098
264050MP	50	20 mm	ABS + Elastollan	Blister	1	8421411017104

- (ES) Cinta métrica metálica con gancho francés. Clase II. Estuche bimaterial de ABS con Elastollan y recogedor de cinta reforzado. Versión en mm y versión en mm + pulgadas.
- (EN) Metal tape measure with French hook. Class II. ABS bimaterial case with Elastollan and reinforced tape winder. Version in mm and version in mm + inches.
- (DE) Metallmaßband mit Nullpunkt an vorderer Beschlagkante (Maßanfang B). Klasse II. Millimeterskala. 2K-Gehäuse aus ABS und Elastollan und verstärkter Bandaufroller. Ausführung in mm sowie in mm + Zoll.



# CINTAS MÉTRICAS METÁLICAS

STEEL LONG TAPES

METALL-MAßBÄNDER



CINTA MÉTRICA 100 M	REF.	m					
---------------------	------	---	--	--	--	--	--

2675100	100	13 mm	Metal	Blister	1	8421411005859
---------	-----	-------	-------	---------	---	---------------



- (ES) Cinta métrica metálica con gancho francés. Clase II. Graduación milimétrica y recogedor de cinta reforzado.
- (EN) Metal tape measure with French hook. Class II. Millimetric graduation and reinforced tape retractor.
- (DE) Metallmaßband mit Nullpunkt an vorderer Beschlagkante (Maßanfang B). Klasse II. Millimeterskala und verstärkter Bandaufroller.

CINTA MÉTRICA METÁLICA	REF.	m					
------------------------	------	---	--	--	--	--	--

266030	30	13 mm	ABS + Elast. + Alu.	Maleta	1	8421411011843
266050	50	13 mm	ABS + Elast. + Alu.	Maleta	1	8421411009147



- (ES) Cinta métrica metálica con gancho francés y estuche abierto. Clase II. Graduación milimétrica y recogedor de cinta reforzado.
- (EN) Metal tape measure with a French hook and an open case. Class II. Millimeter graduation and reinforced tape retractor.
- (DE) Metallmaßband mit Nullpunkt an vorderer Beschlagkante (Maßanfang B) und offenem Gehäuse. Klasse II. Millimeterskala und verstärkter Bandaufroller.

CINTA MÉTRICA METÁLICA	REF.	m					
------------------------	------	---	--	--	--	--	--

276050	50	13 mm	ABS + Elastollan	Blister	1	8421411014967
2760100	100	13 mm	ABS + Elastollan	Blister	1	8421411014974

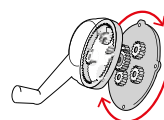
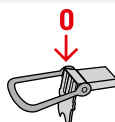

- (ES) Alta velocidad de retorno 3:1
- (EN) High speed return 3:1
- (DE) Hohe Rücklaufgeschwindigkeit 3:1.

- (ES) Cinta métrica metálica con gancho francés y estuche abierto bimaterial para garantizar una alta velocidad de retorno. Clase II. Graduación milimétrica y recogedor de cinta reforzado.
- (EN) Metal tape measure with a French hook and a bimaterial open case to ensure high return speed. Class II. Millimeter graduation and reinforced tape retractor.
- (DE) Metallmaßband mit Nullpunkt an vorderer Beschlagkante (Maßanfang B) und offenem 2K-Gehäuse für ein schnelles Aufrollen. Klasse II. Millimeterskala und verstärkter Bandaufroller.

CINTA MÉTRICA 15 M	REF.	m					
--------------------	------	---	--	--	--	--	--

185	15	10 mm	ABS	Blister	1	8421411015018
-----	----	-------	-----	---------	---	---------------

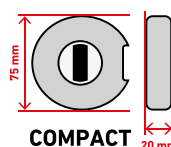
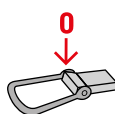

- (ES) Cinta métrica metálica con estuche ABS, de reducidas dimensiones. Clase II. Graduación milimétrica y recogedor de cinta reforzado.
- (EN) Metal tape measure with a compact ABS case. Class II. Millimeter graduation and reinforced tape retractor.
- (DE) Kleines Metallmaßband mit ABS-Gehäuse. Klasse II. Millimeterskala und verstärkter Bandaufroller.

# SONDAS

TANK DIPPING TAPES

TANKBANDMASSE

SONDAS: DISPONIBLES EN 3 MODELOS



## SONDAS ACERO INOXIDABLE

REF.	m				
296110	10	13 mm	ABS + Elast. + Alu.	1	8421411005484
296120	20	13 mm	ABS + Elast. + Alu.	1	8421411005491
296130	30	13 mm	ABS + Elast. + Alu.	1	8421411005507



- (ES) Sonda de acero inoxidable con plomada en acero inoxidable. Números grabados para mayor resistencia. Resistente al agua, disolventes y mezclas ligeramente ácidas. Clase II. Graduación milimétrica.
- (EN) Stainless steel tank dipping tape with stainless steel plumb bob. Engraved numbers for greater durability. Resistant to water, solvents, and mildly acidic mixtures. Class II. Millimeter graduation.
- (DE) Tankbandmaß mit Senklot aus Edelstahl. Eingravierte Zahlen für erhöhte Widerstandsfähigkeit. Beständigkeit gegen Wasser, Lösungsmittel und leicht saure Mischungen. Klasse II. Millimeterskala.

### ACERO INOXIDABLE / STAINLESS STEEL COMPOSICIÓN QUÍMICA / CHEMICAL COMPOSITION %

TRADEMARK	C	Si	Mn	P	S	Ni	Cr
420JE	0.237 %	≤ 0.280 %	≤ 0.350 %	≤ 0.023 %	≤ 13.30 %	≤ 0,6 %	13.30 %

## SONDAS ACERO AL CARBONO

REF.	m				
294030	30	13 mm	ABS + Elast. + Alu.	1	8421411005460



- (ES) Sonda de acero al carbono con plomada de latón. Números grabados para mayor resistencia. Para aceites, similares y ciertos disolventes. Clase II. Graduación milimétrica.
- (EN) Carbon steel tank dipping tape with brass plumb bob. Engraved numbers for greater durability. Suitable for oils, similar substances, and certain solvents. Class II. Millimeter graduation.
- (DE) Tankbandmaß aus Kohlenstoffstahl mit Senklot aus Blei. Eingravierte Zahlen für erhöhte Widerstandsfähigkeit. Geeignet für Öle, ähnliche Substanzen und bestimmte Lösungsmittel. Klasse II. Millimeterskala.

## SONDAS ACERO ESMALTADO

REF.	m				
291530	30	13 mm	ABS + Elast. + Alu.	1	8421411005361



- (ES) Sonda de acero esmaltado con plomada de latón. Números grabados para mayor resistencia. Para aceites, similares y ciertos disolventes. Clase II. Graduación milimétrica.
- (EN) Enamelled steel tank dipping tape with brass plumb bob. Engraved numbers for greater durability. Suitable for oils, similar substances, and certain solvents. Class II. Millimeter graduation.
- (DE) Tankbandmaß aus emailliertem Stahl mit Senklot aus Blei. Eingravierte Zahlen für erhöhte Widerstandsfähigkeit. Geeignet für Öle, ähnliche Substanzen und bestimmte Lösungsmittel. Klasse II. Millimeterskala.





# MEDICIÓN ELECTRÓNICA

ELECTRONIC MEASUREMENT

ELEKTRONISCHE MESSUNG

## MEDIDOR LÁSER



**NUEVO**

**PUNTERO ROJO**

REF.	m	Color	🎯	📄	📦	📊
53	40	●	±2 mm	Caja	1	8421411022962
56	60	●	±2 mm	Caja	1	8421411022979
58	100	●	±2 mm	Caja	1	8421411023020

- (ES) Medidores láser para interiores con alcance de 40 m, 60 m y 100 m. Luz roja (Ref.53,56,58). Para áreas, distancias y volúmenes. Función Pitágoras.
- (EN) Indoor laser distance meters with a range of 40 m, 60 m, and 100 m. Red light (Ref.53,56,58). For measuring areas, distances, and volumes. Pythagoras function.
- (DE) Laser-Entfernungsmesser für den Innenbereich mit Reichweiten von 40, 60 und 100 m. Roter Laserstrahl (Art.-Nr. 53,56,58). Geeignet für das Messen von Flächen, Distanzen und Volumen. Mit Pythagoras-Funktion.

## MEDIDOR LÁSER



**NUEVO**

**PUNTERO VERDE**

REF.	m	Color	🎯	📄	📦	📊
66	60	●	±2 mm	Caja	1	8421411025444
68	100	●	±2 mm	Caja	1	8421411025451

- (ES) Medidores láser para interiores con alcance de 60 m y 100 m. Luz verde (Ref.66,68). Para áreas, distancias y volúmenes. Función Pitágoras.
- (EN) Indoor laser distance meters with a range of 60 m and 100 m. Green light (Ref.66,68). For measuring areas, distances, and volumes. Pythagoras function.
- (DE) Laser-Entfernungsmesser für den Innenbereich mit Reichweiten von 60 und 100 m. Grüner Laserstrahl (Art.-Nr. 66,68). Geeignet für das Messen von Flächen, Distanzen und Volumen. Mit Pythagoras-Funktion.

## MULTIDETECTOR PROFESIONAL



REF.	Medidas	📄	📦	📊
8075	65 x 18 x 90 mm	Caja	1	8421411024409

- (ES) Multidetector profesional. Localiza metales férricos hasta 120 mm, no férricos de 80 mm, cables AC 50 mm y madera 38 mm. Pantalla LCD con indicador visual y acústico de precisión.
- (EN) Professional multi-detector. Detects ferrous metals up to 120 mm, non-ferrous metals up to 80 mm, AC cables up to 50 mm, and wood up to 38 mm. LCD screen with visual and acoustic precision indicator.
- (DE) Professionelles Ortungsgerät. Lokalisiert Eisenmetalle bis zu 120 mm, nicht-eisenhaltige Metalle bis zu 80 mm, Wechselstromkabel bis zu 50 mm und Holz bis zu 38 mm Tiefe. LCD-Display mit präziser visueller und akustischer Anzeige.

### CARACTERÍSTICAS / CHARACTERISTICS / MERKMALE

Profundidad máxima de escaneo / Maximum Scan Depth / Maximale Scantiefe	Metales magnéticos 120 mm, Metales no magnéticos 80 mm, Cable eléctrico 110/230 V 50 mm, Madera 38 mm / Magnetic metals 120 mm, Non-magnetic metals 80 mm, Electrical cable 110/230 V 50 mm, Wood 38 mm / Magnetische Metalle 120 mm, Nichtmagnetische Metalle 80 mm, Elektrokabel 110/230 V 50 mm, Holz 38 mm
---	--

Grado de protección IP 54 / IP 54 protection grade / Schutzart IP 54

Tipo de pila 1 x 9V. 6RL61 / Battery type 1 x 9V. 6RL61 / Akku-Typ 1 x 9V. 6RL61

Tiempo de funcionamiento +/- 5 h / Operating time +/- 5 h / Betriebszeit +/- 5 h

Auto apagado 5 min. / Auto shutdown 5 min. / Automatische Abschaltung 5 min.



MULTÍMETRO DIGITAL CON ESTUCHE	REF.	Medidas			
	8221	91 x 189 x 32 mm	Caja	1	8421411020401
<p>(ES) Multímetro digital con estuche de protección. Retención de lectura, retro iluminación, continuidad sonora y test diodo.</p> <p>(EN) Digital multimeter with protective case. Reading hold, backlight, audible continuity, and diode test.</p> <p>(DE) Digital-Multimeter mit Schutztasche. Mit Hold-Funktion, Hintergrundbeleuchtung, akustischem Durchgangsprüfer und Diodentest.</p>					
CARACTERÍSTICAS / CHARACTERISTICS / MERKMALE					
Tensión AC / Voltage AC / Wechselspannung	2/20/200/750 V ±0,8 %				
Tensión DC / Voltage DC / Gleichspannung	200 mV/2/20/200/1000 V ±0,5 %				
Corriente AC / Current AC / Wechselstrom	2/20/200 mA/10 A ±1,2 %				
Corriente DC / Current DC / Gleichstrom	2/20/200 mA/10 A ±0,8 %				
Resistencia / Resistance / Widerstand	200/2 k/20/200 k/2 m/20 m Ω ±0,8 %				

MULTÍMETRO DIGITAL	REF.	Medidas			
	8067	91 x 189 x 32 mm	Caja	1	8421411020425
<p>(ES) Multímetro digital con estuche de protección. Retención de lectura, retro iluminación, continuidad sonora y test diodo.</p> <p>(EN) Digital multimeter with protective case. Reading hold, backlight, audible continuity, and diode test.</p> <p>(DE) Digital-Multimeter mit Schutztasche. Mit Hold-Funktion, Hintergrundbeleuchtung, akustischem Durchgangsprüfer und Diodentest.</p>					
CARACTERÍSTICAS / CHARACTERISTICS / MERKMALE					
Tensión AC / Voltage AC / Wechselspannung	4/40/400 V ±0,8 % / 700 V ±1,2 %				
Tensión DC / Voltage DC / Gleichspannung	400 mV ±0,8 % / 4/40/400 V ±0,5 % 1000 V ±0,8 %				
Corriente AC / Current AC / Wechselstrom	4 mA ±1,2 % / 400 mA ±1,6 % 10 A ±3 %				
Corriente DC / Current DC / Gleichstrom	4 mA ±0,8 % / 400 mA ±1,2 % 10 A ±2 %				
Resistencia / Resistance / Widerstand	400/4 k/40 k/400 k/4 M Ω ±0,8 % 40 M Ω ±1,2 %				
Capacidad / Capacity / Kapazität	4 nF ±(5 % +5) 40 nF/400 nF/4 uF/40 uF/100 uF ±(3 % ±3)				

MULTÍMETRO DIGITAL DE BOLSILLO	REF.	Medidas			
	8320	70 x 120 x 18 mm	Caja	1	8421411020418
<p>(ES) Multímetro digital con estuche de protección. Retención de lectura, retro iluminación, continuidad sonora y test diodo.</p> <p>(EN) Digital multimeter with protective case. Reading hold, backlight, audible continuity, and diode test.</p> <p>(DE) Digital-Multimeter mit Schutztasche. Mit Hold-Funktion, Hintergrundbeleuchtung, akustischem Durchgangsprüfer und Diodentest.</p>					
CARACTERÍSTICAS / CHARACTERISTICS / MERKMALE					
Tensión AC / Voltage AC / Wechselspannung	4/40/400/600 V ±0,8 %				
Tensión DC / Voltage DC / Gleichspannung	0.4 V/4/400/600 V ±0,7 %				
Corriente AC / Current AC / Wechselstrom	40/400 mA				
Corriente DC / Current DC / Gleichstrom	40/400 mA				
Resistencia / Resistance / Widerstand	400/4 k/40 k/400 k/4 M Ω ±1,2 % 40 M Ω ±2 %				

## MULTÍMETRO DIGITAL

REF.

Medidas



8064

91 x 189 x 32 mm

Caja

1

8421411020432



- (ES) Multímetro digital con estuche de protección. Retención de lectura, retro iluminación, continuidad sonora, test diodo y test transistor hFE: 1/1000.
- (EN) Digital multimeter with protective case. Reading hold, backlight, audible continuity, diode test, and transistor hFE test: 1/1000.
- (DE) Digital-Multimeter mit Schutztasche. Mit Hold-Funktion, Hintergrundbeleuchtung, akustischem Durchgangsprüfer sowie Dioden- und hFE-Transistortest 1/1000.

### CARACTERÍSTICAS / CHARACTERISTICS / MERKMALE

Tensión AC / Voltage AC / Wechselspannung	2/20/200 V ±0,8 % / 700 V ±1,2 %
Tensión DC / Voltage DC / Gleichspannung	200 mV/2/20/200 V ±0,5 % 1000 V ±0,8 %
Corriente AC / Current AC / Wechselstrom	2mA/20mA ±1 % / 200mA ±1,8 % 10A ±3 %
Corriente DC / Current DC / Gleichstrom	4mA ±0,8 % / 400mA ±1,2 % 10A ±2 %
Resistencia / Resistance / Widerstand	200/2 k/20 k/200 k/2 M Ω ±0,8 % 20M Ω ±1 % / 200 M Ω ±5 %
Capacidad / Capacity / Kapazität	2 n/20 n/200 n/2 μ/20 μ ±4 %

## PINZA AMPERIMÉTRICA DIGITAL

REF.

Medidas



8310

70 x 120 x 37 mm

Caja

1

8421411020449



- (ES) Pinza amperimétrica digital. Con estuche de protección. Retención de lectura, retro-iluminación, continuidad sonora y test diodo.
- (EN) Digital clamp ammeter with protective case. Reading hold, backlight, audible continuity, and diode test.
- (DE) Stromzangen-Multimeter mit Schutztasche. Mit Hold-Funktion, Hintergrundbeleuchtung, akustischem Durchgangsprüfer und Diodentest.

### CARACTERÍSTICAS / CHARACTERISTICS / MERKMALE

Tensión AC / Voltage AC / Wechselspannung	750V (±1,2 % + 5)
Tensión DC / Voltage DC / Gleichspannung	1000 V (±1 % + 2)
Corriente AC / Current AC / Wechselstrom	20/200/1000 A (±2 % + 5)
Resistencia / Resistance / Widerstand	200/2 K Ω

## PINZA AMPERIMÉTRICA DIGITAL

REF.

Medidas



8311

86 x 225 x 32 mm

Caja

1

8421411020456



- (ES) Pinza amperimétrica digital. Con estuche de protección. Retención de lectura, retro-iluminación, continuidad sonora y test diodo.
- (EN) Digital clamp ammeter with protective case. Reading hold, backlight, audible continuity, and diode test.
- (DE) Stromzangen-Multimeter mit Schutztasche. Mit Hold-Funktion, Hintergrundbeleuchtung, akustischem Durchgangsprüfer und Diodentest.

### CARACTERÍSTICAS / CHARACTERISTICS / MERKMALE

Tensión AC / Voltage AC / Wechselspannung	4/40/400/700 V (±1,2 % + 5)
Tensión DC / Voltage DC / Gleichspannung	400mV/4/40/400/1000 V (±0,8 % + 5)
Corriente AC / Current AC / Wechselstrom	400/1000 A (±3 % + 8)
Intensidad DC / Intensity DC / Gleichstrom	400/1000 A (±3 % + 5)
Resistencia / Resistance / Widerstand	400/4/40/400 k/4/40 M Ω (±1 % + 5)
Capacidad / Capacity / Kapazität	4/40/400 nF/4/40 μF
Frecuencia / Frequency / Frequenz	10/100/1 K/10K/100 K/200 K (±0,1 % + 2) kHz

# MEDICIÓN ELECTRÓNICA

ELECTRONIC MEASUREMENT

ELEKTRONISCHE MESSUNG



MEDIDOR DE ESPESORES	REF.	Medidas			
	8041	135 x 61 28 mm	Maleta	1	8421411020463
<p>(ES) Medidor de espesores. Aplicable en metal, plástico, cristal y cerámica. Rango de medición: 1,2 a 225 mm placas de acero, tubos min. ø 20 mm 3 mm grosor.</p> <p>(EN) Thickness gauge. Applicable on metal, plastic, glass, and ceramics. Measurement range: 1.2 to 225 mm for steel plates, minimum 20 mm diameter for tubes, with a thickness of 3 mm.</p> <p>(DE) Dickenmessgerät. Anwendbar auf Metall, Kunststoff, Glas und Keramik. Messbereich: 1,2 bis 225 mm für Stahlplatten, Rohre mit mindestens ø 20 mm und 3 mm Dicke.</p>					
CARACTERÍSTICAS / CHARACTERISTICS / MERKMALE					
Medición ultrasónicos / Ultrasound mesurer / Ultraschallmessung					5 Mhz
Resolución / Resolution / Auflösung					0,1 mm
Precisión / Accuracy / Genauigkeit					±1 % +0,1 mm
Tiempo respuesta / Sample rate / Messzeit					0,5 s

MEDIDOR DE HUMEDAD EN MATERIALES	REF.	Medidas			
	8040	121 x 60 x 30 mm	Maleta	1	8421411020616
<p>(ES) Medidor de humedad de materiales. Aplicable en madera, cemento, mortero, yeso, tocho, retro-iluminación y °C/°F.</p> <p>(EN) Material moisture meter. Applicable on wood, cement, mortar, plaster, brick, with backlight and °C/°F temperature measurement.</p> <p>(DE) Feuchtigkeitsmesser für Materialien. Anwendbar auf Holz, Zement, Mörtel, Gips und Ziegel, mit Hintergrundbeleuchtung und °C/°F-Anzeige.</p>					
CARACTERÍSTICAS / CHARACTERISTICS / MERKMALE					
Higrometría / Humidity / Feuchtigkeitsmessung					0 a 95,7 %
Resolución humedad / Humidity resolution / Auflösung Feuchtigkeit					0,1 % RH
Precisión humedad / Humidity accuracy / Genauigkeit Feuchtigkeit					±2 % RH
Temperatura / Temperature / Temperatur					- 10 / 50 °C
Resolución temperatura / Temperature resolution / Auflösung Temperatur					0,1 °C
Precisión temperatura / Temperature accuracy / Genauigkeit Temperatur					±1 °C
Tiempo de respuesta / Sample rate / Messzeit					1 s

MEDIDOR DE HUMEDAD AMBIENTAL	REF.	Medidas			
	8010	121 x 60 x 30 mm	Maleta	1	8421411020609
<p>(ES) Medidor de humedad ambiental. Función: Máx/Mín, retención de lectura, retro-iluminación y °C/°F.</p> <p>(EN) Environmental humidity meter. Functions: Max/Min, reading hold, backlight, and °C/°F temperature measurement.</p> <p>(DE) Luftfeuchtigkeitsmesser. Funktionen: Max/Min-Anzeige, Hold-Funktion, Hintergrundbeleuchtung und °C/°F-Anzeige.</p>					
CARACTERÍSTICAS / CHARACTERISTICS / MERKMALE					
Higrometría / Humidity / Feuchtigkeitsmessung					0 a 100 %
Resolución humedad / Humidity resolution / Auflösung Feuchtigkeit					0,1 % RH
Precisión humedad / Humidity accuracy / Genauigkeit Feuchtigkeit					±3 % RH < 95 % RH
Temperatura / Temperature / Temperatur					-10 / 50 °C
Resolución temperatura / Temperature resolution / Auflösung Temperatur					0,1 °C
Precisión temperatura / Temperature accuracy / Genauigkeit Temperatur					±1 °C
Tiempo de respuesta / Sample rate / Messzeit					1 s

## TAQUÍMETRO



REF.	Medidas			
8030	121 x 60 x 30 mm	Maleta	1	8421411020470

- (ES) Taquímetro para medición a distancia. Retención de lectura, Máx/Mín, puntero láser y retro-iluminación.
- (EN) Tachometer for distance measurement. Reading hold, Max/Min, laser pointer, and backlight.
- (DE) Tachymeter zur Entfernungsmessung. Hold-Funktion, Max/Min-Anzeige, Laserpointer und Hintergrundbeleuchtung.

### CARACTERÍSTICAS / CHARACTERISTICS / MERKMALE

Rotación / Rotation / Rotation	100-30.000 rpm
Resolución / Resolution / Auflösung	0,1 (100-1.000 rpm) 1 (1.000-30.000 rpm)
Precisión / Accuracy / Genauigkeit	+ 0,1 % < 10.000 rpm + 0,021 % 10.000 < 30.000 rpm
Tiempo respuesta / Sample rate / Messzeit	1 s

## LUXÓMETRO DIGITAL



REF.	Medidas			
8050	121 x 60 x 30 mm	Maleta	1	8421411020487

- (ES) Luxómetro digital compacto. Retención de lectura, Máx/Mín, retro-iluminación y Lux/FC.
- (EN) Compact digital lux meter. Reading hold, Max/Min, backlight, and Lux/FC measurement.
- (DE) Kompaktes Digital-Luxmeter. Hold-Funktion, Max/Min-Anzeige, Hintergrundbeleuchtung und Lux/FC-Anzeige.

### CARACTERÍSTICAS / CHARACTERISTICS / MERKMALE

Medición / Range / Messung	30.000 Lux
Resolución / Resolution / Auflösung	1 Lux
Precisión / Accuracy / Genauigkeit	±4 % 50 uni.
Tiempo respuesta / Sample rate / Messzeit	1 s

## LUXÓMETRO DIGITAL



REF.	Medidas			
6610	126 x 72 x 27 mm	Caja + Bolsa	1	8421411020494

- (ES) Luxómetro digital. Retención de lectura y medición 50.000 Lux
- (EN) Digital Lux meter. Reading hold and measurement up to 50,000 Lux.
- (DE) Digital-Luxmeter. Hold-Funktion und Messbereich bis 50.000 Lux.

### CARACTERÍSTICAS / CHARACTERISTICS / MERKMALE

Medición / Range / Messung	50.000 Lux
Resolución / Resolution / Auflösung	0-1.999 (1 Lux) 2.000-19.990 (10 Lux) 20.000-50.000 (100 Lux)
Precisión / Accuracy / Genauigkeit	5 %
Tiempo respuesta / Sample rate / Messzeit	2 s



**ANEMÓMETRO-TERMÓMETRO** REF. Medidas

**8020** 157 x 60 x 30 mm Maleta 1 8421411020500



- (ES) Anemómetro-termómetro. Máx./Mín./retención de lectura, retro-iluminación, m/s, km/h, fpm, mph, kts, Beaufort, td y °C/°F.
- (EN) Anemometer-thermometer. Max/Min/reading hold, backlight, m/s, km/h, fpm, mph, kts, Beaufort, dew point, and °C/°F.
- (DE) Anemometer-Thermometer. Max/Min-Anzeige/ Hold-Funktion, Hintergrundbeleuchtung, m/s, km/h, fpm, mph, kts, Beaufort, % RH, Taupunkt und ° C/F-Anzeige.

**CARACTERÍSTICAS / CHARACTERISTICS / MERKMALE**

	Anemómetro / Vane anemometer / Anemometer	Termómetro / Temperature / Thermometer
Rango de medición / Measurement range / Messbereich	0,4 a 20 m/s	-10 a 50 °C
Resolución / Resolution / Auflösung	0,1 m/s	0,1 °C
Precisión / Accuracy / Genauigkeit	2 % + 0,3 m/s	±1 °C
Caudal de aire / Airflow / Luftstrom	0 a 100.000 m3/s	-
Precisión / Accuracy / Genauigkeit	3 %	-
Tiempo de respuesta / Sample rate / Messzeit		1s

**ANEMÓMETRO-TERMÓMETRO-HIGRÓMETRO** REF. Medidas

**8021** 157 x 60 x 30 mm Maleta 1 8421411020517



- (ES) Anemómetro-termómetro-higrómetro. Máx./Mín./retención de lectura, retro-iluminación, m/s, km/h, fpm, mph, kts, Beaufort, % RH, td y ° C/°F.
- (EN) Anemometer-thermometer-hygrometer. Max/Min/reading hold, backlight, m/s, km/h, fpm, mph, kts, Beaufort, % RH, dew point, and ° C/°F.
- (DE) Anemometer-Thermometer-Hygrometer. Max/Min-Anzeige/ Hold-Funktion, Hintergrundbeleuchtung, m/s, km/h, fpm, mph, kts, Beaufort, % RH, Taupunkt und ° C/°F-Anzeige.

**CARACTERÍSTICAS / CHARACTERISTICS / MERKMALE**

• ANEMÓMETRO / VANE ANEMOMETER / ANEMOMETER	0,4 a 20 m/s
Resolución / Resolution / Auflösung	0,1 m/s
Precisión / Accuracy / Genauigkeit	2 % + 0,3 m/s
• TERMÓMETRO / THERMOMETER / THERMOMETER	-10 a 50 °C
Resolución / Resolution / Auflösung	0,1 °C
Precisión / Accuracy / Genauigkeit	±1 °C
• HIGROMETRÍA / HIGROMETRIE / FEUCHTIGKEITSMESSE	0 a 100 RH
Resolución humedad / Humidity resolution / Auflösung Feuchtigkeit	0,1 RH
Precisión humedad / Humidity accuracy / Genauigkeit Feuchtigkeit	±3 % < 95 RH

**SONÓMETRO** REF. Medidas

**8080** 124 x 60 x 30 mm Maleta 1 8421411020524



- (ES) Sonómetro con un rango de medición de 30 a 120 dB y una resolución de 0,1 dB.
- (EN) Sound level meter with a measurement range of 30 to 120 dB and a resolution of 0.1 dB.
- (DE) Schallpegelmesser mit einem Messbereich von 30 bis 120 dB und einer Auflösung von 0,1 dB.

**CARACTERÍSTICAS / CHARACTERISTICS / MERKMALE**

Rango de medición / Measurement range / Messbereich	30 a 120 dB
Resolución / Resolution / Auflösung	0,1 dB
Precisión / Accuracy / Genauigkeit	1,5 dB < 94 dB
Tiempo de respuesta analógico / Analogical sample rate / Messzeit analog	0,25
Tiempo de respuesta digital / Digital sample rate / Messzeit digital	0,75

# TERMÓMETROS

THERMOMETERS

THERMOMETER

## TERMÓMETRO INFRARROJOS COMPACT

REF.

Medidas



6510

98 x 58 x 22 mm

Blister

1

8421411020531



- (ES) Termómetro infrarrojos compact puntero láser. Ratio 6:1. Retención de lectura, lectura temperatura ambiente, retro-iluminación y °C/°F.
- (EN) Compact infrared thermometer with laser pointer. 6:1 ratio. Reading hold, ambient temperature reading, backlight, and °C/°F.
- (DE) Kompaktes Infrarot-Thermometer mit Laserpointer. Optik 6:1. Hold-Funktion, Anzeige der Umgebungstemperatur, Hintergrundbeleuchtung und °C/°F-Anzeige.

### CARACTERÍSTICAS / CHARACTERISTICS / MERKMALE

Emisividad fija / Stationary emissivity / Fest eingestellter Emissionsgrad	0,95
Rango de medición / Measurement range / Messbereich	-20 / 270 °C
Resolución / Resolution / Auflösung	0,1 °C
Precisión / Accuracy / Genauigkeit	-20 a 0 °C ±5 °C 0 a 270 °C 1,5 % ±3 °C
Alcance / Range / Reichweite	1 m

## TERMÓMETRO INFRARROJOS

REF.

Medidas



520

162 x 56 x 90 mm

Caja + Bolsa

1

8421411015056



- (ES) Termómetro infrarrojos puntero láser. Ratio 8:1. Retención de lectura, Máx./Mín./Media, lectura temperatura ambiente, retro-iluminación y °C/°F.
- (EN) Infrared thermometer with laser pointer. 8:1 ratio. Reading hold, Max/Min/Average, ambient temperature reading, backlight, and °C/°F.
- (DE) Infrarot-Thermometer mit Laserpointer. Optik 8:1. Hold-Funktion, Max/Min/Durchschnittswert, Anzeige der Umgebungstemperatur, Hintergrundbeleuchtung und °C/°F-Anzeige.

### CARACTERÍSTICAS / CHARACTERISTICS / MERKMALE

Emisividad fija / Stationary emissivity / Fest eingestellter Emissionsgrad	0,95
Rango de medición / Measurement range / Messbereich	-20° / 520 °C
Resolución / Resolution / Auflösung	0,1 °C
Precisión / Accuracy / Genauigkeit	±2 °C (±3 °F) or ±2 %
Alcance / Range / Reichweite	<1,5 m

## TERMÓMETRO INFRARROJOS

REF.

Medidas



6530

162 x 56 x 190 mm

Caja + Bolsa

1

8421411020548



- (ES) Termómetro infrarrojos industrial puntero láser. Ratio 12:1. Retención de lectura, Máx./Mín./Media, lectura temperatura ambiente, retro-iluminación y °C/°F.
- (EN) Industrial infrared thermometer with laser pointer. 12:1 ratio. Reading hold, Max/Min/Average, ambient temperature reading, backlight, and °C/°F.
- (DE) Industrielles Infrarot-Thermometer mit Laserpointer. Optik 12:1. Hold-Funktion, Max/Min/Durchschnittswert, Anzeige der Umgebungstemperatur, Hintergrundbeleuchtung und °C/°F-Anzeige.

### CARACTERÍSTICAS / CHARACTERISTICS / MERKMALE

Emisividad fija / Stationary emissivity / Fest eingestellter Emissionsgrad	0,95
Rango de medición / Measurement range / Messbereich	-20 / 530 °C
Resolución / Resolution / Auflösung	0,1 °C
Alcance / Range / Reichweite	-20 a 50 °C ±2,5 °C 50 a 530 °C 1 % ±1 °C

# TERMÓMETROS

THERMOMETERS

THERMOMETER



TERMÓMETRO INFRARROJOS	REF.	Medidas			
	6532	162 x 56 x 190 mm	Caja + Bolsa	1	8421411020555
<p>(ES) Termómetro infrarrojos puntero láser regulable. Ratio 12:1. Función: Retención de lectura, Máx./Mín./Media, lectura temperatura ambiente, retro-iluminación y °C/°F.</p> <p>(EN) Adjustable laser pointer infrared thermometer. 12:1 ratio. Functions: Reading hold, Max/Min/Average, ambient temperature reading, backlight, and °C/°F.</p> <p>(DE) Infrarot-Thermometer mit einstellbarem Laserpointer. Optik 12:1. Funktionen: Hold-Funktion, Max/Min/Durchschnittswert, Anzeige der Umgebungstemperatur, Hintergrundbeleuchtung und °C/°F-Anzeige.</p>					
CARACTERÍSTICAS / CHARACTERISTICS / MERKMALE					
Emisividad fija / Stationary emissivity / Fest eingestellter Emissionsgrad					0,1 a 1
Rango de medición / Measurement range / Messbereich					-20 / 530 °C
Resolución / Resolution / Auflösung					0,1 °C
Precisión / Accuracy / Genauigkeit					-20 a 50 °C ±2,5 °C 50 a 530 °C 1 % ±1 °C

TERMÓMETRO DIGITAL INFRARROJOS	REF.	Medidas			
	521	160 x 95 x 46 mm	Caja	1	8421411024607
<p><b>ADECUADO PARA TEMPERATURAS CORPORALES</b>  <b>SUITS BODY TEMPERATURES</b>  <b>GEEIGNET FÜR KÖRPETEMPERATUREN</b></p> <p>(ES) Termómetro digital por infrarrojos. Con pantalla retroiluminada y aviso sonoro y visible. Medición de materiales y temperaturas corporales.</p> <p>(EN) Digital infrared thermometer. With backlit screen and audible and visible alert. Measurement of materials and body temperatures.</p> <p>(DE) Digitales Infrarot-Thermometer. Mit Hintergrundbeleuchtung sowie akustischer und optischer Meldung. Messung von Materialien und Körpertemperaturen.</p>					

TERMÓMETRO SONDA INDUSTRIAL	REF.	Medidas			
	5989	181 x 35 x 20 mm	Caja	1	8421411009390
<p>(ES) Termómetro sonda industrial. Función: Retro-iluminación y °C/°F.</p> <p>(EN) Industrial probe thermometer. Functions: Backlight and °C/°F.</p> <p>(DE) Industrielles Thermometer mit Fühler. Funktionen: Hintergrundbeleuchtung und °C/°F-Anzeige.</p>					
CARACTERÍSTICAS / CHARACTERISTICS / MERKMALE					
Rango de medición / Measurement range / Messbereich					-50 / 270 °C
Resolución / Resolution / Auflösung					0,1 °C
Precisión / Accuracy / Genauigkeit					-50 a -20 °C ±1,5 % + 1 °C -20 a 200 °C ±1 % + 1 °C 200 a 270 °C ±2 % + 4 °C

TERMÓMETRO SONDA K	REF.	Medidas			
	6500	126 x 72 x 27 mm	Blister	1	8421411020562
<p>(ES) Termómetro con sonda K intercambiable. Función: Retención de lectura y °C/°F. Rango de medición: -50 a 700 °C.</p> <p>(EN) Thermometer with interchangeable K-type probe. Functions: Reading hold and °C/°F. Measurement range: -50 to 700 °C.</p> <p>(DE) Thermometer mit auswechselbarem Thermoelement. Funktionen: Hold-Funktion und °C/°F-Anzeige. Messbereich: -50 bis +700 °C.</p>					
CARACTERÍSTICAS / CHARACTERISTICS / MERKMALE					
Rango de medición / Measurement range / Messbereich					-50 / 700 °C
Resolución / Resolution / Auflösung					1 °C
Precisión / Accuracy / Genauigkeit					-50 a 0 °C ±3 °C 0 a 500 °C ±0,75 °C 500 a 700 °C ±1 °C
Sonda / Probe / Fühler					Ref. 3411

# TERMÓMETROS

THERMOMETERS

THERMOMETER

## TERMO-HIGRÓMETRO DIGITAL

REF.

Medidas



5821

100 x 108 mm

Caja

1

8421411012062



- (ES) Termo-higrómetro digital, gran pantalla LCD. Memoria máxima y mínima. Soporte de pared y sobremesa.
- (EN) Digital thermo-hygrometer, large LCD screen. Maximum and minimum memory. Wall-mountable and tabletop stand.
- (DE) Digitales Thermometer/Hygrometer mit großem LCD-Display. Speichert Maximal- und Mindestwert. Wandbefestigung und Tischaufstellung möglich.

## TERMÓMETROS DIGITALES

REF.

Medidas



5822

61 x 84 mm

Caja

1

8421411009048

5863

110 x 123 mm

Caja

1

8421411020104

5882

81 x 31 x 132 mm

Caja

1

4009816024756



5822



5863



5882

- (ES) Termómetro digital para interiores y exteriores.
- (EN) Digital thermometer for indoors and outdoors.
- (DE) Digitales Thermometer für Innen- und Außenbereiche.

## TERMÓMETRO PARA EXTERIORES

REF.

Medidas



419

233 x 55 mm

Blister

1

8421411007709



- (ES) Termómetro de plástico para exteriores.
- (EN) Plastic thermometer for outdoors.
- (DE) Kunststoff-Thermometer für den Außenbereich.

## TERMÓMETRO PARA NEVERAS

REF.

Medidas



409

150 x 24 mm

Caja

1

8421411007693

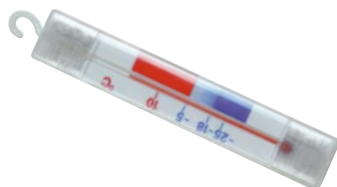

- (ES) Termómetro para nevera.
- (EN) Refrigerator thermometer.
- (DE) Kühlschrank-Thermometer.



# TOPÓMETROS

ROAD MEASURING WHEELS

MESSRÄDER



TOPÓMETRO	REF.	Ø Rueda	Lectura	Capacidad		
-----------	------	---------	---------	-----------	--	--



592000

<b>592000</b>	318,5 mm	m/dm	9999,99 m	99,95 %	8421411003824
---------------	----------	------	-----------	---------	---------------

- (ES) Topómetro con llanta de acero y recubrimiento de neopreno. Freno integrado y mango plegable. El Topómetro dispone de un caballete de apoyo.
- (EN) Topometer with steel wheel and neoprene coating. Integrated brake and folding handle. The topometer has a support stand.
- (DE) Messrad aus Stahl mit Neoprenbeschichtung. Integrierte Bremse und klappbarer Griff. Das Messrad verfügt über einen Stützbock.



TOPÓMETRO	REF.	Ø Rueda	Lectura	Capacidad		
-----------	------	---------	---------	-----------	--	--



582000

<b>572000</b>	320 mm	m/dm	9999,9 m	99,95 %	8421411022368
<b>582000</b>	320 mm	m/dm	9999,9 m	99,95 %	8421411015650

- (ES) Topómetro con rueda de ABS y recubrimiento de neopreno, botón freno y botón de puesta a cero, integrados en el mango. Incluye bolsa de transporte.
- (EN) Topometer with ABS wheel and neoprene coating, integrated brake button and zero button in the handle. Includes carrying bag.
- (DE) Messrad aus ABS mit Neoprenbeschichtung, Brems- und Nullstelltaste im Griff integriert. Inklusive Transporttasche.

TOPÓMETRO	REF.	Ø Rueda	Lectura	Capacidad		
-----------	------	---------	---------	-----------	--	--



591000

<b>591000</b>	320 mm	m/dm	10000 m	99,95 %	8421411014486
---------------	--------	------	---------	---------	---------------

- (ES) Topómetro con rueda de ABS y recubrimiento de neopreno, botón freno y botón de puesta a cero, integrados en el mango. Incluye bolsa de transporte.
- (EN) Topometer with ABS wheel and neoprene coating, integrated brake button and zero button in the handle. Includes carrying bag.
- (DE) Messrad aus ABS mit Neoprenbeschichtung, Brems- und Nullstelltaste im Griff integriert. Inklusive Transporttasche.



# TOPÓMETROS

ROAD MEASURING WHEELS

MESSRÄDER

TOPÓMETRO	REF.	Ø Rueda	Lectura	Capacidad		
-----------	------	---------	---------	-----------	--	--

595000	320 mm	m/dm	10000 m	99,95 %	8421411011942
--------	--------	------	---------	---------	---------------



- (ES) Topómetro modelo Elephant. Tiene rueda de ABS con recubrimiento de neopreno. Incluye bolsa de transporte.
- (EN) Elephant model topometer. It has an ABS wheel with neoprene coating. Includes carrying bag.
- (DE) Messrad Modell Elephant. ABS-Rad mit Neoprenbeschichtung. Inklusive Transporttasche.



TOPÓMETRO	REF.	Ø Rueda	Lectura	Capacidad		
-----------	------	---------	---------	-----------	--	--

585000	320 mm	m/dm	9999,9 m	99,95 %	8421411012222
--------	--------	------	----------	---------	---------------



- (ES) Topómetro plegable con luz. Tiene rueda de ABS con recubrimiento de neopreno y botón freno integrado en el mango.
- (EN) Folding topometer with light. It has an ABS wheel with neoprene coating and an integrated brake button in the handle.
- (DE) Klappbares Messrad mit Licht. ABS-Rad mit Neoprenbeschichtung, Bremsstaste im Griff integriert.



TOPÓMETRO	REF.	Ø Rueda	Lectura	Capacidad		
-----------	------	---------	---------	-----------	--	--

593000	160 mm	m/dm	1000 m	99,95 %	8421411012239
--------	--------	------	--------	---------	---------------



- (ES) Mini-topómetro con rueda de ABS y recubrimiento de neopreno. Tiene botón freno integrado. Incluye bolsa de transporte.
- (EN) Mini topometer with ABS wheel and neoprene coating. It has an integrated brake button. Includes carrying bag.
- (DE) Mini-Messrad aus ABS mit Neoprenbeschichtung. Mit integrierter Bremsstaste. Inklusive Transporttasche.

# ESCUADRAS

SQUARES

WINKELMESSGERÄTE



ESCUADRA EN ACERO Y ALUMINIO	REF.	mm			
	2048	200	Si	1	8421411005729
	2049	250	Si	1	8421411005736
	2050	300	Si	1	8421411003671
	2051	400	Si	1	8421411003688

TOP  
QUALITY

Escuadra profesional en acero inoxidable y talonera de aluminio rectificadas. Graduación grabada.

Professional stainless steel square with a ground aluminum stock. Engraved graduation.

Professioneller Winkelmesser aus Edelstahl mit Anschlag aus geschliffenem Aluminium. Gravierte Gradeinteilung.

ESCUADRA GRADUABLE EN ALUMINIO	REF.	mm			
	930	300	Blister	1	8421411014189

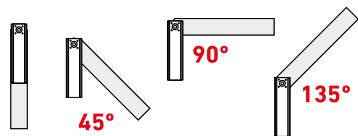

Escuadra de aluminio y ajustable en varios ángulos: 45°, 90° y 135°.

Aluminum square that is adjustable at various angles: 45°, 90°, and 135°.

Winkelmesser aus Aluminium, einstellbar auf verschiedene Winkel: 45°, 90° und 135°.

ESCUADRAS AJUSTABLE EN ACERO Y MADERA	REF.	mm			
	3061	300	Si	1	8421411011386

Escuadra ajustable. Hecha en acero y madera.

Adjustable square. Made of steel and wood.

Verstellbarer Winkelmesser aus Stahl und Holz.

ESCUADRAS AJUSTABLE EN ACERO	REF.	mm			
	3048	300	Si	1	8421411006665

Escuadra ajustable de acero.

Adjustable steel square.

Verstellbarer Winkelmesser aus Stahl.

ESCUADRA BRICOLAJE METÁLICA	REF.	mm			
	ESY300	300	Si	1	8421411011089

Escuadra metálica. Ideal bricolaje.

Metal square. Ideal for DIY.

Winkelmesser aus Metall. Ideal für Heimwerkerarbeiten.

# ESCUADRAS Y CARTABÓN

SET SQUARE AND T-SQUARE

WINKEL UND LINEAL

## ESCUADRAS BRICOLAJE METÁLICA



REF.	mm			
1050	300	Si	1	8421411006641

- (ES) Escuadra metálica en amarillo. Ideal bricolaje.
- (EN) Metal square in yellow. Ideal for DIY.
- (DE) Winkelmesser aus Metall in Gelb. Ideal für werkerarbeiten.

## ESCUADRA BUSCADORA DE ÁNGULOS

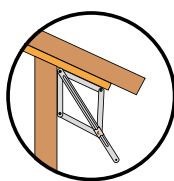

REF.	mm			
6040	165 x 320	Si	1	8421411014394

- (ES) Escuadra de aluminio buscadora de ángulos, interiores de 5° - 85° y exteriores de 10° - 170°
- (EN) Aluminum angle finder square, interior angles from 5° to 85° and exterior angles to 10° - 170°.
- (DE) Zentrierwinkel aus Aluminium, Innenwinkel von 5° - 85° und Außenwinkel von 10° - 170°.

## CARTABÓN PLEGABLE



REF.	mm			
3600	595 x 840	Si	1	8421411014387

- (ES) Cartabón plegable de aluminio.
- (EN) Folding aluminum set square.
- (DE) Klappbarer Bauwinkel aus Aluminium.

## ESCUADRA MAGNÉTICA



REF.	mm			
7903	75	Si	1	8421411024317
7904	100	Si	1	8421411024324
7905	125	Si	1	8421411024331

- (ES) Escuadra magnética en forma de flecha.
- (EN) Magnetic arrow-shaped square.
- (DE) Magnetischer pfeilförmiger Winkelmesser.

## ESCUADRAS DE ALBAÑIL

**BIG SIZE**



REF.	mm			
40020	400 x 200	Si	1	8421411016947
50025	500 x 250	Si	1	8421411016954
60030	600 x 300	Si	1	8421411016961
80040	800 x 400	Si	1	8421411016978
100050	1000 x 500	Si	1	8421411016985

- (ES) Escuadras de gran tamaño. Ideales para albañil.
- (EN) Large-size squares. Ideal for masons
- (DE) Große Winkelmesser. Ideal für Bauarbeiten.



# REGLAS Y TELESCÓMETRO

RULES AND TELESCOPE

LINEAL UND TELESKOPMESSSTAB



REGLA SEMI-RÍGIDA MATE	REF.	mm						
	<b>105601</b>	300	30 mm	0,8 mm	Ambas caras	Si	1	8421411001240
	<b>105602</b>	500	30 mm	0,8 mm	Ambas caras	Si	1	8421411001257
	<b>105603</b>	1000	30 mm	0,8 mm	1 cara	Si	1	8421411001264
	<b>105604</b>	1500	30 mm	0,8 mm	1 cara	Si	1	8421411001271

(ES) Regla semirrígida mate. Hecha de acero inoxidable.  
 (EN) Matte semi-rigid ruler. Made of stainless steel.  
 (DE) Mattes, halbstarres Lineal. Hergestellt aus Edelstahl.

REGLA SEMI-RÍGIDA MATE	REF.	mm						
	<b>1511</b>	150	18 mm	0,7 mm	1 cara	Si	1	8421411008720
	<b>3011</b>	300	25 mm	0,8 mm	1 cara	Si	1	8421411008737
	<b>5011</b>	500	27 mm	0,8 mm	Ambas caras	Si	1	8421411008744

**TOP QUALITY**

(ES) Regla semirrígida mate. Hecha de acero inoxidable.  
 (EN) Matte semi-rigid ruler. Made of stainless steel.  
 (DE) Mattes, halbstarres Lineal. Hergestellt aus Edelstahl.

REGLA FLEXIBLE MATE	REF.	mm						
	<b>105102</b>	150	13 mm	0,5 mm	Ambas caras	Si	1	8421411001165
	<b>105103</b>	200	13 mm	0,5 mm	Ambas caras	Si	1	8421411001172
	<b>105104</b>	250	13 mm	0,5 mm	Ambas caras	Si	1	8421411001189
	<b>105105</b>	300	13 mm	0,5 mm	Ambas caras	Si	1	8421411001196
	<b>105106</b>	500	20 mm	0,5 mm	Ambas caras	Si	1	8421411001202
	<b>105107</b>	1000	25 mm	0,5 mm	Ambas caras	Si	1	8421411001219
	<b>105108</b>	1500	25 mm	0,5 mm	Ambas caras	Si	1	8421411001226
	<b>105109</b>	2000	25 mm	0,5 mm	Ambas caras	Si	1	8421411001233

(ES) Regla flexible de acero inoxidable con grabado en ambas caras.  
 (EN) Flexible stainless steel ruler with engraving on both sides.  
 (DE) Flexibles Lineal aus Edelstahl, beidseitig graviert.

TELESCÓMETRO	REF.	Máx	Min			
	<b>71062</b>	3 m	0,75 m	Caja	1	8421411011171
	<b>71065</b>	5 m	1,10 m	Caja	1	8421411011188

(ES) Instrumento de medición telescópica realizado en aluminio. Ideal para medición en altura. Con burbujas vertical y horizontal.  
 (EN) Telescopic measuring instrument made of aluminum. Ideal for height measurement. With vertical and horizontal bubbles.  
 (DE) Teleskop-Messinstrument aus Aluminium. Ideal für Höhenmessungen. Mit vertikaler und horizontaler Libelle.

# METROS PLEGABLES Y ESCALÍMETRO

FOLDING RULES AND ALUMINUM SCALE RULE

KLAPPMAßBÄNDER UND DREIKANTMASSTAB AUS ALUMINIUM

## METROS PLEGABLES DE MADERA



4040



2040

**TOP  
QUALITY**

REF.	m	n°	Material	Color			
4040	2	10	Madera		Caja	10	8421411011317
2040	2	10	Madera		Caja	5	8421411011096

- (ES) Metro plegable de madera. Graduación Milimétrica. Precisión Clase III.
- (EN) Folding wooden meter. Millimeter graduation. Class III accuracy.
- (DE) Zollstock aus Holz. Millimeterskala. Genauigkeitsklasse III.

## METROS PLEGABLES BLANCO Y NEGRO



REF.	m	n°	Material	Color			
2000	2	10	Fibra de vidrio		Caja	10	8421411003602
2002	2	10	Aluminio		Caja	10	8421411013229
2012	2	10	Fibra de vidrio		Caja	10	8421411014523
2022	2	10	Aluminio		Caja	10	8421411014530

- (ES) Metro plegable. Graduación Milimétrica. Precisión Clase III.
- (EN) Folding meter. Millimeter graduation. Class III accuracy.
- (DE) Zollstock aus Holz. Millimeterskala. Genauigkeitsklasse III.

## METROS PLEGABLES DE MADERA AMARILLO



REF.	m	n°	Material	Color			
2009	1	5	Madera		Caja	10	8421411003657

- (ES) Metro plegable. Graduación Milimétrica. Precisión Clase III.
- (EN) Folding meter. Millimeter graduation. Class III accuracy.
- (DE) Zollstock aus Holz. Millimeterskala. Genauigkeitsklasse III.

## CINTAS METÁLICAS AUTOADHESIVAS



REF.	m				
218	2	13 mm	Caja	1	8421411011102
318	3	13 mm	Caja	1	8421411011119
1018	10	13 mm	Caja	1	8421411011126

- (ES) Cinta metálica autoadhesiva.
- (EN) Self-adhesive metal tape.
- (DE) Selbstklebendes Maßband aus Metall.

## ESCALÍMETRO



REF.	m	Escalas			
2030	2	1:20/25/50/75/100	Caja	1	8421411014363

- (ES) Escalímetro de aluminio. Varias escalas disponibles.
- (EN) Aluminum scale ruler. Various scales available.
- (DE) Dreikantmaßstab aus Aluminium. Verschiedene Skalen erhältlich.

# CALIBRES Y TRANSMISOR-RECEPTOR BLUETOOTH

SCALE RULERS AND BLUETOOTH TRANSCIVER

SCHIEBLEHREN UND BLUETOOTH-TRANSCIVER



CALIBRE DIGITAL	REF.						
	CDE	0,01 mm	150 mm	40 mm	Blister	1	8421411001899

ES Calibre digital de acero inoxidable. Con precisión 0,01 mm.  
EN Stainless steel digital caliper. With 0.01 mm precision.  
DE Digital Messschieber. Mit einer Genauigkeit von 0,01 mm.

**INOX** **DIGITAL**

CALIBRE DIGITAL	REF.	m				
	213203	300 mm	105 mm	Blister	1	8421411024416
	213205	500 mm	105 mm	Blister	1	8421411024423
	213210	1000 mm	105 mm	Blister	1	8421411024430

ES Calibre digital de acero inoxidable con sonda para medir la profundidad.  
EN Stainless steel digital caliper with depth gauge.  
DE Digital Messschieber aus Edelstahl mit Tiefenlehre.

TRANSMISOR/RECEPTOR BLUETOOTH	REF.			
	213200	Caja	1	8421411024447

ES Transmisor y receptor Bluetooth que permite descargar directamente en el ordenador las mediciones realizadas.  
EN Bluetooth transmitter and receiver that allows direct downloading of measurements to the computer.  
DE Bluetooth-Sender und Empfänger, der das direkte Herunterladen von Messungen auf den Computer ermöglicht.

**TOP QUALITY**

CALIBRE DIGITAL STAR	REF.						
	2019	0,01 mm	150 mm	40 mm	Blister	1	8421411023143

ES Calibre digital de acero inoxidable. Freno con tornillo. Con precisión 0,01 mm.  
EN Stainless steel digital caliper with screw lock. Accuracy of 0.01 mm.  
DE Digital Messschieber aus Edelstahl mit Schraubenklemmung. Mit einer Genauigkeit von 0,01 mm.

**INOX** **DIGITAL**

# CALIBRES

CALIPERS

MESSSCHIEBER

## CALIBRE MONOBLOCK A PULSANTE

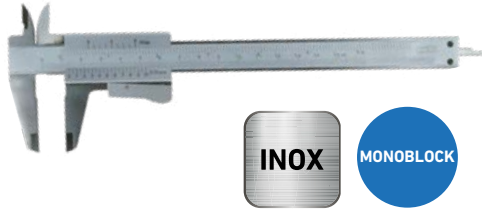

REF.			mm			
2350	0,05 mm	300 mm	410	Funda	1	8421411008065
2220	0,05 mm	200 mm	290	Funda	1	8421411003749
2217	0,05 mm	150 mm	230	Funda	1	8421411003732

- (ES) Calibre de acero inoxidable cromado mate. Freno pulsante. Con precisión 0,05 mm.
- (EN) Matte chrome-plated stainless steel caliper. Push-button lock. Accuracy of 0.05 mm.
- (DE) Messschieber aus matt verchromtem Edelstahl. Mit Momentklemmung. Mit einer Genauigkeit von 0,05 mm.

## CALIBRE MONOBLOCK A TORNILLO

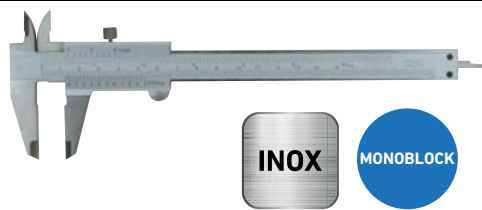

REF.			mm			
2350T	0,05 mm	300 mm	410	Funda	1	8421411013212
2220T	0,05 mm	200 mm	290	Funda	1	8421411013205
2217T	0,05 mm	150 mm	230	Funda	1	8421411013199

- (ES) Calibre de acero inoxidable cromado mate. Tornillo prisionero. Con precisión 0,05 mm.
- (EN) Matte chrome-plated stainless steel caliper. Set screw lock. Accuracy of 0.05 mm.
- (DE) Messschieber aus matt verchromtem Edelstahl. Mit Schraubenklemmung. Mit einer Genauigkeit von 0,05 mm.

## CALIBRE ACERO INOX



REF.			mm			
213103	0,05 mm	300 mm	85	Caja	1	8421411019931
213106	0,05 mm	500 mm	140	Caja	1	8421411019948
213109	0,05 mm	600 mm	150	Caja	1	8421411019955
213112	0,05 mm	800 mm	200	Caja	1	8421411019962
213116	0,05 mm	1000 mm	290	Caja	1	8421411019979

- (ES) Calibre de tornero. Hecho de acero inoxidable. Con precisión 0,05 mm.
- (EN) Turner's caliper. Made of stainless steel. Precision of 0.05 mm.
- (DE) Innen-Messschieber aus Edelstahl. Mit einer Genauigkeit von 0,05 mm.

## CALIBRE DE PRECISIÓN CON CUADRANTE



REF.						
491	0,02 mm	150 mm	40 mm	Caja	1	8421411001967

- (ES) Calibre con cuadrante. Con precisión 0,02 mm.
- (EN) Caliper with dial gauge. Accuracy of 0.02 mm.
- (DE) Messschieber mit Messuhr. Mit einer Genauigkeit von 0,02 mm.

## CALIBRE PARA TRAZAR + RECAMBIO PUNTA



REF.			mm			
CT200	0,01 mm	200 mm	200 mm	Caja	1	8421411015643
CTR	0,02 mm	200 mm	200 mm	Caja	1	8421411016046

- (ES) Calibres para trazar con una punta widia. Con precisión 0,01 mm y 0,02 mm.
- (EN) Calipers for marking with a carbide tip. Accuracy 0.01 mm and 0.02 mm.
- (DE) Anreiß-Messschieber mit einer Wolframkarbid-Spitze. Mit einer Genauigkeit von 0,01 mm und 0,02 mm.



# CALIBRES

CALIPERS

MESSSCHIEBER



CALIBRE PROFUNDIDAD DE ACERO INOX	REF.			mm			
	<b>C582</b>	0,02 mm	200 mm	200	Caja	1	8421411015568
	<b>C583</b>	0,02 mm	300 mm	300	Caja	1	8421411015575

(ES) Calibre de profundidad. Hecho de acero inoxidable. Con precisión 0,02 mm.  
(EN) Depth caliper. Made of stainless steel. Accuracy 0.02 mm.  
(DE) Tiefenlehre aus Edelstahl. Mit einer Genauigkeit von 0,02 mm.

CALIBRE DE ACERO AL CARBONO MATE	REF.			mm			
	<b>2016</b>	0,05 mm	150 mm	230	Blister	1	8421411010914

(ES) Calibre antirreflectante de acero al carbono. Freno pulsante. Con precisión 0,05 mm.  
(EN) Anti-reflective carbon steel caliper. With push-button brake. Accuracy 0.05 mm.  
(DE) Messschieber aus Kohlenstoffstahl mit matter Oberfläche. Mit Momentklemmung. Mit einer Genauigkeit von 0,05 mm.

CALIBRE DE LATÓN	REF.			mm			
	<b>1820</b>	0,1 mm	100 mm	115	Skin	1	8421411008713

(ES) Calibre de latón. Con precisión 0,01 mm.  
(EN) Brass caliper. Accuracy 0.01 mm.  
(DE) Messschieber aus Messing. Mit einer Genauigkeit von 0,01 mm.

CALIBRE DE ACERO	REF.			mm			
	<b>1910</b>	0,1 mm	100 mm	220	Skin	1	8421411006993

(ES) Calibre de acero. Con precisión 0,01 mm.  
(EN) Steel caliper. Accuracy 0.01 mm.  
(DE) Messschieber aus Stahl. Mit einer Genauigkeit von 0,01 mm.

CALIBRE DE PLÁSTICO PVC	REF.			mm			
	<b>1815</b>	0,05 mm	155 mm	230	Skin	1	8421411006658

(ES) Calibre de plástico. Con precisión 0,05 mm.  
(EN) Plastic caliper. Accuracy 0.05 mm.  
(DE) Messschieber aus Kunststoff. Mit einer Genauigkeit von 0,05 mm.

## MICRÓMETRO EXTERIORES



REF.					
<b>M100025</b>	0,01 mm	0-25 mm	Caja	1	8421411001004
<b>M1002550</b>	0,01 mm	25-50 mm	Caja	1	8421411001011
<b>M1005075</b>	0,01 mm	50-75 mm	Caja	1	8421411001028
<b>M10075100</b>	0,01 mm	75-100 mm	Caja	1	8421411001035

- Micrómetro de exteriores con una precisión de 0,01 mm. Distintos tamaños disponibles.
- Outside micrometer with a precision of 0.01 mm. Various sizes available.
- Mikrometer mit einer Genauigkeit von 0,01 mm. Verschiedene Größen erhältlich.

## MICRÓMETRO DIGITAL EXTERIORES



REF.					
<b>DM125</b>	0,01 mm	0-25 mm	Caja	1	8421411015605
<b>DM150</b>	0,01 mm	25-50 mm	Caja	1	8421411015612
<b>DM175</b>	0,01 mm	50-75 mm	Caja	1	8421411015629
<b>DM100</b>	0,01 mm	75-100 mm	Caja	1	8421411015636

- Micrómetro de exteriores digital con una precisión de 0,01 mm. Distintos tamaños disponibles.
- Digital outside micrometer with a precision of 0.01 mm. Various sizes available.
- Digital Mikrometer mit einer Genauigkeit von 0,01 mm. Verschiedene Größen erhältlich.

## RELOJ COMPARADOR



REF.	Modelo			
<b>254101</b>	Sin orejas	Caja	1	8421411001844
<b>254102</b>	Con orejas	Caja	1	8421411001851

- Reloj comparador con una precisión de 0,01 mm.
- Comparator gauge with a precision of 0.01 mm.
- Messuhr mit einer Genauigkeit von 0,01 mm.

## SOPORTE COMPARADOR MAGNÉTICO



REF.	Medidas			
<b>566</b>	65 x 50 x 55 mm	Caja	1	8421411002063

- Soporte comparador magnético.
- Magnetic comparator stand.
- Magnetische Messuhr-Halterung.

GRAMIL	REF.	↕ mm	📏	📦	📦	📦	📦
	<b>T-300</b>	300	300 mm	Caja	1	8421411015551	
	<b>T-550</b>	550	500 mm	Caja	1	8421411001677	
	<b>2226.01</b>	470	300 mm	Caja	1	8421411019863	
	<b>2226.02</b>	715	500 mm	Caja	1	8421411019870	
	<b>2226.04</b>	1270	1000 mm	Caja	1	8421411019887	

- Ⓔ Gramil con una precisión de 0,02 mm.
- Ⓔ Scriber with a precision of 0.02 mm.
- Ⓔ Höhenreißer mit einer Genauigkeit von 0,02 mm.

MEDIDOR ESPESORES DE BOLSILLO	REF.	📏	📏	📦	📦	📦
	<b>6401</b>	0,01 mm	0 -10 mm	Caja	1	8421411003909
	<b>6402</b>	0,01 mm	0 -20 mm	Caja	1	8421411003916
	<b>6403</b>	0,01 mm	0 -30 mm	Caja	1	8421411003923

- Ⓔ Medidor de espesores de bolsillo con una precisión de 0,01 mm.
- Ⓔ Pocket thickness gauge with a precision of 0.01 mm.
- Ⓔ Taschen-Dickenmesser mit einer Genauigkeit von 0,01 mm.



CONTADOR MANUAL	REF.	📦	📦	📦
	<b>82371</b>	Caja	1	8421411006702

- Ⓔ Contador manual de 4 dígitos.
- Ⓔ 4-digit manual tally counter.
- Ⓔ 4-stelliger Handzähler.

CRONÓMETRO	REF.	📏	📦	📦	📦
	<b>941</b>	1/100 seg.	Caja	1	8421411009369

- Ⓔ Cronómetro digital.
- Ⓔ Digitaler Chronometer.
- Ⓔ Digitale Stoppuhr.

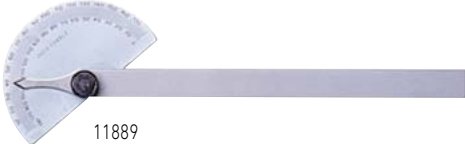

TRANSPORTADORES DE ÁNGULOS	REF.	MEDIDAS	L			
 <p>11889</p>  <p>G-03</p>	<b>11889</b>	140	155 mm	Blister	1	8421411001455
	<b>G-03</b>	240	200 mm	Blister	1	8421411000212

- (ES) Transportador de ángulos de acero inoxidable 0 - 180°.
- (EN) Stainless steel angle protractor 0 - 180°.
- (DE) Winkelmesser aus Edelstahl 0 - 180°.

GALGAS ESPESORES	REF.	Láminas	Largo			
 <p>10008</p>  <p>3552</p>	<b>10008</b>	8	100 mm	Caja	1	8421411015438
	<b>10013</b>	13	100 mm	Caja	1	8421411015445
	<b>10020</b>	20	100 mm	Caja	1	8421411015452
	<b>20008</b>	8	200 mm	Caja	1	8421411015469
	<b>20013</b>	13	200 mm	Caja	1	8421411015476
	<b>20020</b>	20	200 mm	Caja	1	8421411015483
	<b>30008</b>	8	300 mm	Caja	1	8421411015490
	<b>3552</b>	52	69 mm	Caja	1	8421411015520

- (ES) Galgas de acero para medición de espesores.
- (EN) Steel feeler gauges for thickness measurement.
- (DE) Fühlerlehren aus Stahl zur Dickenmessung.

PUNZONES	REF.	Medidas			
	<b>102005</b>	1,6 - 2 - 2,4 - 3,6 - 4 mm	Funda	1	8421411023372

- (ES) Juego de 5 punzones de punta redonda.
- (EN) Set of 5 round-tip punches.
- (DE) Set bestehend aus 5 Körnern mit abgerundeter Spitze.

BOTADORES	REF.	Medidas			
	<b>102006</b>	2, 3, 4, 5, 6 y 8 mm	Funda	1	8421411023389

- (ES) Juego de 6 botadores.
- (EN) Set of 6 drift punches.
- (DE) Set mit 6 Durchschlagstiften.



# ESCUADRAS Y PUNTAS TRAZADORAS

SQUARES AND MARKING POINTS

WINKEL UND ANREIßSPITZEN



ESCUADRA MECÁNICO ACERO AL CARBONO	REF.	DIN	Medidas			
	NF22010070	DIN 875/1	100 x 70 mm	Si	1	8421411001707
	NF220150100	DIN 875/1	150 x 100 mm	Si	1	8421411001714
	NF220200130	DIN 875/1	200 x 130 mm	Si	1	8421411001721
	NF220250160	DIN 875/1	250 x 160 mm	Si	1	8421411001738

(ES) Escuadra de mecánico de acero al carbono lisa. DIN 875/1.  
 (EN) Square for mechanics, made of smooth carbon steel. DIN 875/1.  
 (DE) Glatter Schlosserwinkel aus Kohlenstoffstahl. DIN 875/1.

ESCUADRA MECÁNICO ACERO AL CARBONO	REF.	DIN	Medidas			
	NF22110070	DIN 875/1	100 x 70 mm	Si	1	8421411001790
	NF221150100	DIN 875/1	150 x 100 mm	Si	1	8421411001806
	NF221200130	DIN 875/1	200 x 130 mm	Si	1	8421411001813
	NF221250160	DIN 875/1	250 x 160 mm	Si	1	8421411001820

(ES) Escuadra de mecánico de acero al carbono con sombrero. DIN 875/1.  
 (EN) Square for mechanics, made of carbon steel with a hat. DIN 875/1.  
 (DE) Schlosserwinkel aus Kohlenstoffstahl mit Anschlag. DIN 875/1.

ESCUADRA DE MECÁNICO	REF.	mm			
	222	300 x 180	Si	1	8421411013236

(ES) Escuadra de mecánico de acero al carbono con sombrero. No calibrada.  
 (EN) Square for mechanics, made of carbon steel with hat. Not calibrated.  
 (DE) Schlosserwinkel aus Kohlenstoffstahl mit Anschlag. Nicht geschliffen.

PUNTAS Y LÁPICES	REF.	mm				
	31	200	45°	Si	1	8421411001868
	35	150	--	Si	1	8421411013281
	33	250	90°	Si	1	8421411001875
	34	150	--	Si	1	8421411001882
	32	140	--	Si	1	8421411013274

(ES) Puntas trazador: De acero (31 y 33), para cerámica (35). Lápiz trazador metálico, cuerpo aluminio, punta widia (34) y punta widia retráctil (32).  
 (EN) Tracer tips: Steel (31 and 33), for ceramic (35). Metal tracer pencil, aluminum body, carbide tip (34), and retractable carbide tip (32).  
 (DE) Anreißspitzen: Aus Stahl (31 und 33), für Keramik (35). Reißnadel aus Metall, Aluminiumschaft, Widia-Spitze (34) und versenkbare Widia-Spitze (32).

# COMPASES

COMPASSES

ZIRKEL

## COMPÁS DE 2 PUNTAS / 2 PUNTAS CON REGLA



REF.	MODELO	L	☁	📦	📊
5250	2 puntas	250 mm	Si	1	8421411013250
5250A	2 puntas con regla	250 mm	Si	1	8421411013267

- Ⓔ ES Compás de 2 puntas de 250 mm.
- Ⓔ EN 250 mm double-ended compass.
- Ⓔ DE Zirkel, 250 mm.

## COMPÁS DE MUELLE



REF.	MODELO	L	☁	📦	📊
7150	Palas rectas	150 mm	Si	1	8421411000823
7200	Palas rectas	200 mm	Si	1	8421411000830
7250	Palas rectas	250 mm	Si	1	8421411000854
8150	Exteriores	150 mm	Si	1	8421411000892
8200	Exteriores	200 mm	Si	1	8421411000908
8250	Exteriores	250 mm	Si	1	8421411000922
9150	Interiores	150 mm	Si	1	8421411000953
9200	Interiores	200 mm	Si	1	8421411000960
9250	Interiores	250 mm	Si	1	8421411000984

- Ⓔ ES Compás de muelle. Disponible en modelos de patas rectas, para interiores y para exteriores.
- Ⓔ EN Spring compass. Available in models with straight legs, for indoors, and for outdoors.
- Ⓔ DE Federzirkel. Erhältlich mit geraden Schenkeln sowie für Innen- und Außenanwendungen.

## COMPÁS CON PORTALÁPICES



REF.	MODELO	L	☁	📦	📊
4200	Portalápices	200 mm	Si	1	8421411013243

- Ⓔ ES Compás de 200 mm con portalápices.
- Ⓔ EN 200 mm compass with pencil holder.
- Ⓔ DE Zirkel, 200 mm mit Bleistifthalter.

# VARIOS

MISCELLANEOUS

VERSCHIEDENES



CINTAS DE SASTRE		REF.	m			Color			
		<b>169</b>	1,5	20 mm	0,5 mm	●	Caja	1	8421411005781
		<b>184</b>	1,5	20 mm	0,5 mm	●	Caja	1	8421411045798
		<b>193</b>	1,5	20 mm	0,5 mm	○	Caja	1	8421411005811
		<b>373-E</b>	1,5	20 mm	0,5 mm	●	Caja	1	8421411013274

- (ES) Cinta de sastre amarilla de 1,5 m y 20 mm de anchura. Impresión en negro.
- (EN) Yellow tailor's tape measure, 1,5 m long and 20 mm wide. Black printing.
- (DE) Gelbes Schneidermaßband, 1,5 m lang und 20 mm breit. Mit schwarzen Zahlen.

VARA DE MADERA		REF.	LONGITUD				
		<b>2100</b>	1 m	25 x 20 mm	Si	1	8421411003695

- (ES) Vara de madera con cantoneras y punta metálica.
- (EN) Wooden rule with metal corner protectors.
- (DE) Holzstab mit Endkappen und Metallspitze.

PLUVIÓMETRO DE LECTURA DIRECTA		REF.	Capacidad			
		<b>995</b>	0-40 L/m <sup>2</sup>	Blister	1	8421411009376

- (ES) Pluviómetro de lectura directa.
- (EN) Direct reading rain gauge.
- (DE) Direkt ablesbarer Regenmesser.

CUENTAHILOS METÁLICOS		REF.	∅ mm	Aumentos			
		<b>9271</b>	15 x 15 mm	7x	Caja	1	8421411007815
		<b>9273</b>	25 x 25 mm	6x	Caja	1	8421411017822

- (ES) Cuentahilos metálico con un aumento de 7x y 6x.
- (EN) Metal hand counter with 7x and 6x magnification.
- (DE) Fadenzähler aus Metall mit 7-facher und 6-facher Vergrößerung.

LUPA CON MANGO DE PLÁSTICO		REF.	∅ mm	Aumentos			
		<b>MD9202</b>	50 mm	6x	Caja	1	8421411007754
		<b>9203</b>	50 mm	3x	Caja	1	8421411025048
		<b>9164</b>	50 mm	8x	Caja	1	8421411025048

- (ES) Lupas con mango de plástico. Las Ref. 9203 y 9164 tienen LEDs.
- (EN) Magnifiers with plastic handle. Reference numbers 9203 and 9164 have LEDs.
- (DE) Lupen mit Kunststoffgriff. Die Artikelnummern 9203 und 9164 verfügen über LEDs.





# NIVELES PROFESIONALES DE ALTA PRECISIÓN

PROFESSIONAL LEVELS OF HIGH ACCURACY

HOCHPRÄZISE PROFI-WASSERWAAGEN



NIVEL LASER 3D VERDE	REF.	Color	m				
----------------------	------	-------	---	--	--	--	--

5663 ● 30 0,3 mm / m Maleta 1 8421411025291



**NUEVO**

RAYO VERDE

- (ES) Nivel láser 3D de rayo verde. 3 líneas: horizontal / vertical frontal / vertical lateral. Alcance de 30 m (con detector 50 m).
- (EN) 3D Green Beam Laser Level. 3 lines: horizontal / front vertical / side vertical. Range of 30 m (with detector 50 m).
- (DE) Grüner 3D-Linienlaser. 3 Linien: horizontal / vertikal vorne / vertikal seitlich. Reichweite von 30 m (mit Empfänger 50 m).



**INCLUYE:**  
Maleta rígida con accesorios.

- (ES) Funciona con batería. Clase II. IP 54. RAYO VERDE
- (EN) Battery-operated. Class II. IP 54. GREEN BEAM.
- (DE) Batteriebetrieben. Class II. IP 54. GRÜNER STRAHL.

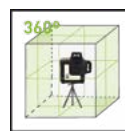

## ESPECIFICACIONES TÉCNICAS / TECHNICAL SPECIFICATIONS / TECHNISCHE DATEN

Líneas horizontal, vertical frontal y vertical lateral / Lines horizontal, front vertical and side vertical / Linien horizontal, vertikal vorne und vertikal seitlich.

Alcance 30 m / Range 30 m / Reichweite 30 m

Precisión nivelación / Accuracy / Nivelliergenauigkeit +/- 0,3 mm/m

Rango de auto nivelación / Levelling range / Nivellierbereich +/- 4°

Longitud de onda / Wavelength / Wellenlänge 520 nm

NIVEL LASER LINEA HORIZONTAL 360° + LINEA VERTICAL	REF.	Color	m				
--	------	-------	---	--	--	--	--

5665 ● 30 0,3 mm / m Maleta 1 8421411025307



**NUEVO**

RAYO VERDE

- (ES) Nivel láser de rayo verde. Línea horizontal 360° y un rayo vertical (dos puntos de plomada en rojo). Alcance de 30 m (con detector 50 m).
- (EN) Green Laser Level. 360° horizontal line and a vertical beam (two red plumb dots). Range of 30 m (with detector 50 m).
- (DE) Grüner Linienlaser. 360° horizontale Linie und eine vertikale Linie (zwei rote Lotpunkte). Reichweite von 30 m (mit Empfänger 50 m).



**INCLUYE:**  
Maleta rígida con accesorios.

- (ES) Funciona con batería. Clase II. IP 54. RAYO VERDE
- (EN) Battery-operated. Class II. IP 54. GREEN BEAM.
- (DE) Batteriebetrieben. Class II. IP 54. GRÜNER STRAHL.



## ESPECIFICACIONES TÉCNICAS / TECHNICAL SPECIFICATIONS / TECHNISCHE DATEN

Línea horizontal 360° y un rayo vertical (dos puntos de plomada en rojo) / 360° horizontal line and a vertical beam (two red plumb dots) / 360° horizontale Linie und ein vertikaler Strahl (zwei rote Lotpunkte).

Alcance 30 m / Range 30 m / Reichweite 30 m

Precisión nivelación / Accuracy / Nivelliergenauigkeit +/- 0,3 mm/m

Rango de auto nivelación / Levelling range / Nivellierbereich +/- 4°

Longitud de onda / Wavelength / Wellenlänge 520 nm

# NIVELES PROFESIONALES DE ALTA PRECISIÓN

PROFESSIONAL LEVELS OF HIGH ACCURACY

HOCHPRÄZISE PROFI-WASSERWAAGEN

MINI NIVEL LASER COMPACT VERDE/ROJO	REF.	Color	m				
<p>RAYO VERDE <b>NUEVO</b></p> <p>RAYO ROJO</p>	5661		30	0,4 mm / m	Funda	1	8421411025277
	5631		15	0,4 mm / m	Funda	1	8421411025314

**INCLUYE:** **Caja + funda de protección y accesorios**

- ES** Funciona con pilas 2 AA (no incluidas). Clase II. IP 54. RAYO VERDE Y ROJO
- EN** Operates with 2 AA batteries (not included). Class II. IP 54. GREEN AND RED BEAM.
- DE** Funktioniert mit 2 AA-Batterien (nicht im Lieferumfang enthalten). Class II. IP 54. GRÜNER UND ROTER STRAHL.

## ESPECIFICACIONES TÉCNICAS / TECHNICAL SPECIFICATIONS / TECHNISCHE DATEN

Líneas verticales + horizontales y en cruz / Lines vertical + horizontal and cross / Linien vertikale + horizontale und kreuzlinien.

Alcance / Range / Reichweite 30 m (Ref. 5661) 15 m (Ref. 5631)

Precisión nivelación / Accuracy / Nivelliergenauigkeit +/- 0,4 mm/m

Rango de auto nivelación / Levelling range / Nivellierbereich +/- 4°

Longitud de onda / Wavelength / Wellenlänge 505 – 530 nm (Ref.5661) 635 nm (Ref. 5631)

NIVEL LASER PRO VERDE/ROJO	REF.	Color	m				
<p>RAYO VERDE</p> <p>RAYO ROJO</p> <p><b>NUEVO</b></p>	5662		30	0,4 mm / m	Maleta	1	8421411025284
	5632		15	0,4 mm / m	Funda	1	8421411025321

**INCLUYE:** **5662 con maleta rígida con accesorios**  
**5632 con caja + funda de protección y accesorios**

- ES** Funciona con pilas 4 AA (no incluidas). Clase II. IP 54. RAYO VERDE Y ROJO
- EN** Operates with 4 AA batteries (not included). Class II. IP 54. GREEN AND RED BEAM.
- DE** Funktioniert mit 4 AA-Batterien (nicht im Lieferumfang enthalten). Class II. IP 54. GRÜNER UND ROTER STRAHL.

## ESPECIFICACIONES TÉCNICAS / TECHNICAL SPECIFICATIONS / TECHNISCHE DATEN

Líneas verticales + horizontales y en cruz / Lines vertical + horizontal and cross / Linien vertikale + horizontale und kreuzlinien.

Alcance / Range / Reichweite 30 m (Ref. 5662) 15 m (Ref. 5632)

Precisión nivelación / Accuracy / Nivelliergenauigkeit +/- 0,4 mm/m

Rango de auto nivelación / Levelling range / Nivellierbereich +/- 4°

Longitud de onda / Wavelength / Wellenlänge 505 – 530 nm (Ref.5662) 635 nm (Ref. 5632)

# NIVELES PROFESIONALES DE ALTA PRECISIÓN

PROFESSIONAL LEVELS OF HIGH ACCURACY

HOCHPRÄZISE PROFI-WASSERWAAGEN



NIVEL LÁSER 3D *		REF.	m				
  	 <b>RAYO ROJO</b>	<b>8639</b>	20 m	0,2 mm / m	Maleta	1	8421411024713
		<p>(ES) Nivel láser 3D de rayo rojo. 360° líneas en todas direcciones. Uso en interior hasta 20 m (con detector 60 m). Compatible con rosca 1/4"   Precisión +/-0,2 mm/m Maleta de transporte con soporte multifuncional.</p> <p>(EN) 3D Red beam laser level. 360° lines in all directions. Indoor use up to 20 m (with 60 m detector). Compatible with 1/4" thread Accuracy +/-0.2 mm/m Carrying case with multifunctional support.</p> <p>(DE) Roter Linienlaser. 360° Linien in alle Richtungen. Geeignet für Innenbereiche bis zu 20 m (mit Empfänger 60 m). Kompatibel mit 1/4"-Gewinde   Genauigkeit +/- 0,2 mm/m Transportkoffer mit multifunktionalem Stativ.</p>					
SET NIVEL LÁSER 3D CON TRÍPODE *		REF.	m				
 	 <b>LÁSER ROJO 3 LÍNEAS</b>	<b>8739</b>	30	Caja	1	8421411024683	
		<p>(ES) Nivel láser rayo rojo con trípode y puntal de hasta 3,2 m. 3 líneas. Proyecta luz frontal y techo 90°. Alcance de 30 m, con detector 50 m (no incluido) Advertencia visual y sonora. Rosca de trípode 1/4"</p> <p>(EN) Red beam laser level with tripod and prop up to 3.2 m. 3 lines. Projects front light and roof at 90°. Range of 30 m, with 50 m detector (not included) Visual and audible warning. 1/4" tripod thread.</p> <p>(DE) Roter Laser-Nivellierer mit Stativ und Stange bis zu 3,2 m. 3 Linien. Projiziert Licht nach vorne und zur Decke um 90°. Reichweite von 30 m, mit Detektor 50 m (nicht enthalten). Visuelle und akustische Warnung. Stativgewinde 1/4".</p>					
SET MINI NIVEL LÁSER CON TRIPODE *		REF.	m				
 	 <b>LÁSER ROJO CROSS LINE</b>	<b>8629</b>	20	0,3 mm / m	Maleta	1	8421411024676
		<p>(ES) Nivel láser mini autonivelante de rayo rojo. Líneas y cruz. Uso en interior hasta 20 m. Precisión +/- 0,3 mm/m Trípode incluido de 1,3 m.</p> <p>(EN) Mini self-leveling red beam laser level. Lines and cross. Indoor use up to 20 m. Accuracy +/- 0.3 mm/m. 1.3 m tripod included.</p> <p>(DE) Mini selbstnivellierender Laser-Nivellierer mit rotem Strahl. Linien und Kreuz. Für den Innenbereich bis zu 20 m. Genauigkeit +/- 0,3 mm/m. Enthält ein 1,3 m Stativ.</p>					
NIVEL LÁSER DE 3 LÍNEAS *		REF.	m				
 	 <b>RAYO VERDE</b>	<b>87339</b>	30	Caja	1	8421411024690	
		<p>(ES) Nivel láser autonivelante rayo verde. Proyecta una cruz frontal y otra a techo (90°). Alcance de 30 m. Advertencia visual y sonora del fuera de nivel. Rosca para trípode 1/4". Modos Auto y Manual.</p> <p>(EN) Green beam self-leveling laser level. Project a frontal cross and another to the ceiling (90°). Range of 30 m. Visual and audible warning of out of level. 1/4" tripod thread. Auto and Manual modes.</p> <p>(DE) Selbstnivellierender Linienlaser mit grünem Laserstrahl. Projiziert ein Kreuz nach vorne und ein weiteres zur Decke (90 °). Reichweite von 30 m. Visuelle und akustische Warnung bei Niveauabweichung. 1/4"-Zoll-Gewinde für Stativ. Automatik- und manueller Modus.</p>					
NIVEL MULTILÍNEAS *		REF.	m				
  	 <b>RAYO ROJO</b>  <b>INCLUYE:</b> Bolsa de nylon, láser, cable, gafas, rosca para trípode, batería y diana.	<b>8759</b>	30	0,2 mm / m	Caja	1	8421411024706
		<p>(ES) Nivel láser de rayo rojo. Proyecta 6 rayos láser: 1 horizontal / 4 verticales / 1 punto de plomada. Uso en interior hasta 30 m.con detector 50 m (no incluido) Precisión 0,2 mm/m Modo manual para marcado inclinado. En bolsa de nylon, con accesorios.</p> <p>(EN) Red beam laser level. Projects 6 laser beams: 1 horizontal / 4 vertical / 1 plumb point. Indoor use up to 30 m. with 50 m detector (not included) Accuracy 0.2 mm/m Manual mode for inclined marking. In nylon bag, with accessories.</p> <p>(DE) Mini Linienlaser mit rotem Laserstrahl. Projiziert 6 Laserstrahlen: 1 horizontaler / 4 vertikale / 1 Lotpunkt. Für Innenbereiche bis zu 30 m. Mit Empfänger bis zu 50 m (nicht enthalten). Genauigkeit 0,2 mm/m. Manueller Modus für schräge Markierungen. In Nylon-Tasche mit Zubehör.</p>					

\* REFERENCIAS DISPONIBLES HASTA FIN DE STOCK / REFERENCES AVAILABLE UNTIL THE END OF STOCK / ARTIKEL VORRÄTIG BIS ZUM AUSVERKAUF

# NIVEL LÁSER ROTATORIO Y NIVEL ÓPTICO

ROTATORY LASER LEVEL AND OPTICAL LEVEL

SELBSTNIVELLIERENDER ROTATIONSLASER UND NIVELLIERGERÄT

## NIVEL LÁSER ROTATORIO ROJO/VERDE



RAYO ROJO

5900



RAYO VERDE

5401



REF.	Color	m				
5900	●	50	0,15 mm / m	Maleta	1	8421411016398
5900SET	●	50	0,15 mm / m	Maleta	1	8421411016398
5401	●	50	0,15 mm / m	Maleta	1	8421411016626
5401SET	●	50	0,15 mm / m	Maleta	1	8421411016626

- (ES) Nivel láser rotatorio 360° de rayo rojo o verde. Proyecta línea horizontal o vertical. Uso en interior hasta 50 m, en exterior con detector hasta 250 m.
- (EN) 360° red or green laser rotary level. Projects horizontal and vertical lines. Suitable for indoor use up to 50 m. Outdoors with a detector up to 250 m.
- (DE) 360° Rotationslaser mit rotem/grünem Laserstrahl. Projiziert eine horizontale und eine vertikale Linie. Geeignet für Innenbereiche bis zu 250 m.

### INCLUYE: Maleta y accesorios.

El set trae además 1 regla de nivelación Ref. 5615 + 1 trípode PRO Ref. 5130.

- (ES) Funciona con batería. Clase II. IP 55. RAYO VERDE (Ref. 5401) Y RAYO ROJO (Ref. 5900)
- (EN) Battery-operated. Class II. IP 55. GREEN BEAM (Ref. 5401) AND RED BEAM (Ref. 5900).
- (DE) Batteriebetrieben. Class II. IP 54. GRÜNER STRAHL (Art.-Nr-5401) UND ROTES STRAHL. (Art.-Nr-5900)

### ESPECIFICACIONES TÉCNICAS / TECHNICAL SPECIFICATIONS / TECHNISCHE DATEN

Línea 360° en posición horizontal o vertical / 360° line in horizontal or vertical position / 360° Linie in horizontaler oder vertikaler Position.

Alcance / Range / Reichweite 50 m (250 m en exteriores con detector)

Precisión nivelación / Accuracy / Nivelliergenauigkeit +/- 0,15 mm/m

Velocidades / Speeds / Geschwindigkeiten 5 (0, 60, 120, 300 y 600 giros / minuto)

Modos de escaneo con línea láser visible / Visible laser line scanning modes / Sichtbare Laserlinien-Scanning-Modi 6 (0°, 10°, 45°, 90° y 180°)

## NIVEL ÓPTICO 32 AUMENTOS



### Ref. 5330SET INCLUYE:

1 ud. Ref. 5330  
+ 1 mira topográfica Ref. 314500  
+ 1 trípode PRO ref 5130

Presentado en una resistente maleta de transporte, que incluye una plomada para facilitar su colocación.



REF.				
5330	1,5 mm / Km	Caja	1	8421411016664
5330SET	1,5 mm / Km	Caja	1	8421411016664

- (ES) Nivel óptico de 32 aumentos. Compensación automática mediante amortiguador magnético.
- (EN) Optical level with 32x magnification. Automatic compensation via magnetic damping.
- (DE) Nivelliergerät mit 32-facher Vergrößerung. Automatische Ausrichtung mittel magnetisch gedämpftem Kompensator.

### ESPECIFICACIONES TÉCNICAS / TECHNICAL SPECIFICATIONS / TECHNISCHE DATEN

Aumento / Magnification / Vergrößerung	x32
Apertura de objetivo / Lens aperture / Objektivöffnung	42 mm
Tipo de compensador / Compensator type / Art des Kompensators	Magnético / Magnetic / Magnetisch
Precisión / Accuracy / Genauigkeit	+ - 1,5 mm/Km
Círculo graduado / Circle scale graduation / Teilkreis	360 °
Distancia mínima de enfoque / Minimum target range / Kürzeste Zielweite	0,5 m



# ACCESORIOS NIVELES LÁSER

LASER LEVEL ACCESSORIES

ZUBEHÖR FÜR LINIENLASER



DISPOSITIVO LASER CONTROL EXCAVACIONES	REF.			
	5901	Maleta	1	8421411025437
	<div style="display: flex; justify-content: space-around; align-items: center;"> <div style="text-align: center;"> </div> <div style="text-align: center;"> <p>FIJACIÓN MAGNÉTICA</p> </div> <div style="text-align: center;"> <p>FIJACIÓN CON PINZAS</p> </div> <div style="text-align: center;"> </div> <div style="text-align: center;"> <p><b>INCLUYE MALETA</b></p> </div> </div>			
<p><b>(ES)</b> Dispositivo para controlar el nivel del suelo en las excavaciones y movimientos de tierras. Detecta rayos láser de varios modelos (Rojo: 600 - 680 nm) / Verde: 500 - 540 nm). Detección 360°. Fijación por potentes imanes o pinzas de fijación a rosca. Incluye cargador, cables de conexión, y cables para batería 12/24 V.</p> <p><b>(EN)</b> Device to control the ground level in excavations and earthworks. Detects laser beams of various models (Red: 600 - 680 nm) / Green: 500 - 540 nm). 360° detection. Fixation by powerful magnets or fixing clips threaded. Includes charger, connection cables, and 12/24 V battery cables.</p> <p><b>(DE)</b> Gerät zur Bodenniveauekontrolle bei Ausgrabungen und Erdbewegungen. Erkennt die Laserstrahlen verschiedener Modelle (Rot: 600 - 680 nm / Grün: 500 - 540 nm). 360 ° Erfassung. Befestigung durch starke Magneten oder Gewindeklemmen. Enthält Ladegerät, Verbindungskabel und Kabel für 12/24 V-Batterie.</p>				

GAFAS PARA LÁSER ROJAS/VERDES	REF.	Color			
	5505	<span style="color: red;">●</span>	Caja	1	8421411015131
	58403	<span style="color: green;">●</span>	Caja	1	7290100851302
<p><b>(ES)</b> Gafas láser tintadas en rojo y verde para facilitar la visión de los puntos o líneas láser en condiciones de alta luminosidad.</p> <p><b>(EN)</b> Red and green laser-tinted glasses to enhance the visibility of laser points or lines in high-light conditions.</p> <p><b>(DE)</b> Laserschutzbrillen in Rot und Grün für eine bessere Erkennung der Laserpunkte oder -linien in heller Umgebung.</p>					

DIANA PARA LÁSER ROJO/VERDE	REF.	m	Color			
	5501	150 x 75 mm	<span style="color: red;">●</span>	Caja	1	8421411015124
	58453	170 x 73 mm	<span style="color: green;">●</span>	Caja	1	7290100851296
<p><b>(ES)</b> Diana láser de color rojo/verde con base magnética.</p> <p><b>(EN)</b> Red/Green laser target with magnetic base.</p> <p><b>(DE)</b> Rote/Grüne Zieltafel mit Magnethalterung.</p>						

DETECTOR PARA LÁSER DE LÍNEAS	REF.	Color			
	5507	<span style="color: green;">●</span>	Caja	1	8421411025055
	589404	<span style="color: red;">●</span>	Caja	1	7290100844076
<p><b>(ES)</b> Detector para láser autonivelante de luz verde y luz roja. Detectable desde 1 m hasta 50 m. Incluye soporte para fijar en la regla de nivelación.</p> <p><b>(EN)</b> Self-leveling laser detector with green and red light. Detectable from 1 m to 50 m. Includes a bracket for attaching to the leveling rod.</p> <p><b>(DE)</b> Empfänger für selbstnivellierenden Kreuzlinienlaser mit grünem und rotem Laserstrahl. Erkennt von 1 m bis 50 m. Einschließlich Halterung zur Befestigung an der Nivellierlatte.</p>					

# ACCESORIOS NIVELES LÁSER

LASER LEVEL ACCESORIES

ZUBEHÖR FÜR LINIENLASER

## DETECTOR LÁSER ROTATORIO ROJO/VERDE

REF.



5506

Caja

1

8421411015117

5509

Caja

1

8421411025499



- Ⓔ Detector para láser rotatorio de luz verde y luz roja. Incluye soporte para fijar en la regla de nivelación.
- Ⓔ Rotary laser detector with green and red light. Includes a bracket for attaching to the leveling rod.
- Ⓔ Empfänger für Rotationslaser mit grünem und rotem Laserstrahl. Einschließlich Halterung zur Befestigung an der Nivellierlatte.

## SOPORTE MURAL MAGNÉTICO

REF.



5003

Caja

1

8421411018446



- Ⓔ Soporte con rosca para trípode de ¼" y ⅝". Dos fuertes imanes en la parte vertical y orificio para opción de colgador fijo.
- Ⓔ Threaded tripod mount with ¼" and ⅝" threads. Two strong magnets on the vertical side and a hole for the option of a fixed hanger.
- Ⓔ Halterung mit Gewinde für ¼" und ⅝"-Stativgewinde. Zwei starke Magneten auf der vertikalen Seite und eine Öffnung für die Möglichkeit der Befestigung.

## SOPORTE INCLINABLE

REF.



5110

Caja

1

8421411018446



- Ⓔ Soporte con rosca para trípode de ⅝". La base inclinable permite nivelar inclinaciones con precisión.
- Ⓔ Support with ⅝" tripod thread. The tilting base allows for precise leveling of inclinations.
- Ⓔ Halterung mit Gewinde für ⅝"-Stativgewinde. Die kippbare Auflage ermöglicht präzises Ausrichten von Neigungen.

## ADAPTADOR PARA TRÍPODE

REF.



5841

Caja

1

7290100840948



- Ⓔ Adaptador de rosca para trípode de ¼" a ⅝".
- Ⓔ Thread adapter from ¼" to ⅝" for tripod.
- Ⓔ Gewintheadapter für ¼" auf ⅝" Stativgewinde.

# ACCESORIOS NIVELES LÁSER

LASER LEVEL ACCESORIES

ZUBEHÖR FÜR LINIENLASER



REF.	Altura			
------	--------	--	--	--

REGLA DE NIVELACIÓN ALUM. PARA RECEPTOR LASER MÁX 240M

REF.

Altura



5615

máx. 240 mm

Caja

1

8421411016305

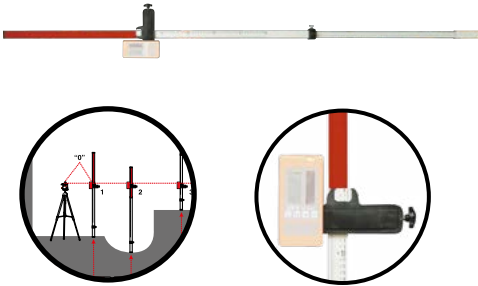

- ES Regla de nivelación de aluminio para receptor láser, extensible hasta 240 cm. Se coloca la marca cero coincidiendo con el cero del receptor en el rayo láser y se desplaza el receptor por la regla de nivelación para medir los diferentes desniveles. Receptor detector y soporte de detector no incluidos, se venden por separado
- EN Aluminum leveling ruler for laser receiver, extendable up to 240 cm. The zero mark is placed coinciding with the zero of the receiver in the laser beam and the receiver is moved along the leveling rule to measure the different unevenness. Detector receiver and detector support not included, sold separately.
- DE Aluminium-Nivellierlatte für Laserempfänger, ausziehbar bis zu 240 cm. Die Nullmarke wird mit der Null des Empfängers im Laserstrahl ausgerichtet und der Empfänger wird entlang der Nivellierlatte verschoben, um verschiedene Neigungen zu messen. Empfänger und Empfängerhalterung nicht im Lieferumfang enthalten, separat erhältlich.

REF.	Peso			
------	------	--	--	--

TRÍPODE DE ALUMINIO CON BURBUJA

REF.

Peso



5310

1,5 kg

Caja

1

8421411015094



- ES Trípode de aluminio con burbuja fácil de transportar. Patas telescópicas. Rosca de 5/8".
- EN Aluminum tripod with easy-to-transport bubble level. Telescopic legs. 5/8" thread.
- DE Aluminium-Stativ mit leicht zu transportierender Wasserwaage. Teleskopische Beine. 5/8"-Gewinde.

REF.	Peso			
------	------	--	--	--

TRÍPODE DE ALUMINIO CON BURBUJA

REF.

Peso



5610

6,5 kg

Caja

1

8421411015179

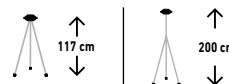

- ES Trípode de aluminio con burbuja. Patas acabadas en punta con silicona para fácil adaptación en cualquier superficie. Rosca de 5/8". Con bolsa de transporte.
- EN Aluminum tripod with bubble level. Legs finished with silicone tips for easy adaptation on any surface. 5/8" thread. Comes with a carrying bag.
- DE Aluminium-Stativ mit Libelle. Die Beine sind mit Silikonenden versehen, um sich leicht an jede Oberfläche anzupassen. 5/8"-Gewinde. Mit Transporttasche.

REF.	Peso			
------	------	--	--	--

TRÍPODE DE ALUMINIO PROFESIONAL

REF.

Peso



5130

4,5 kg

Caja

1

8421411016695

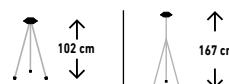

- ES Trípode profesional de base plana. Para uso especial con teodolitos y niveles ópticos. Rosca de 5/8".
- EN Professional flat base tripod. For special use with theodolites and optical levels. 5/8" thread.
- DE Professionelles Stativ mit ebener Auflage. Für spezielle Verwendung mit Theodoliten und Nivelliergeräten. 5/8"-Gewinde.

# ACCESORIOS NIVELES LÁSER

LASER LEVEL ACCESORIES

ZUBEHÖR FÜR LINIENLASER

## MIRA TOPOGRÁFICA TELESCÓPICA

REF.

Medidas



314500

Cerrada 1,25 m / abierta hasta 5 m

Caja

1

8421411002766



- (ES) Mira topográfica telescópica de aluminio extensible. Tiene dos lecturas: en milímetros una cara y topográfica en la opuesta.
- (EN) Telescopic aluminum extendable surveying staff. It has two readings: millimeters on one side and topographical on the opposite side.
- (DE) Aluminium-Flexlatte mit zwei Ablesungen: Millimeter auf einer Seite und topografisch auf der gegenüberliegenden Seite.

## TRÍPODE + PUNTAL TELESCÓPICO

REF.

Altura



5515

4 m

Caja

1

8421411015155



NUEVO  
DISEÑO

- (ES) Trípode con Puntal telescópico. Altura máxima de 4 m.
- (EN) Tripod with telescopic brace. Maximum height of 4 m.
- (DE) Stativ mit Teleskopstange. Maximale Höhe von 4 m.

### (ES) CONTENIDO

Cuatro secciones + una sección telescópica.  
Soporte.  
Punta graduada.  
Bolsa.  
Trípode.

### (EN) CONTENT

Four sections + a section by telescope.  
Support.  
Graduated end.  
Back.  
Tripod.

### (DE) LIEFERUMFANG

Vier Abschnitte + ein Teleskopabschnitt.  
Halterung. Skalenstange.  
Tasche.  
Stativ.





# NIVELES PROFESIONALES

PROFESSIONAL LEVELS

PROFI-WASSERWAAGEN



NIVEL TUBULAR HEAVY DUTY BEST		REF.	cm						
     ↓ Ref. 90060M Ref. 90080M Ref. 900100M Ref. 900150M Ref. 900200M	90060	60	3	0,5 mm / m	Alu.	Caja	1	7290100853412	
	90080	80	3	0,5 mm / m	Alu.	Caja	1	7290100853429	
	900100	100	3	0,5 mm / m	Alu.	Caja	1	7290100853399	
	900150	150	3	0,5 mm / m	Alu.	Caja	1	7290100853405	
	900200	200	3	0,5 mm / m	Alu.	Caja	1	7290100855645	
	90060M	60	3	0,5 mm / m	Alu.	Caja	1	7290100854310	
90080M	80	3	0,5 mm / m	Alu.	Caja	1	7290100854327		
900100M	100	3	0,5 mm / m	Alu.	Caja	1	7290100854334		
900150M	150	3	0,5 mm / m	Alu.	Caja	1	7290100855652		
900200M	200	3	0,5 mm / m	Alu.	Caja	1	7290100855669		



- (ES) Nivel tubular de aluminio con perfil reforzado (1,8 mm). Precisión: 0,5 mm/m. Burbujas con indicación de 2 % inclinación. Asa antideslizante y topes de goma anti golpes. Opción magnética.
- (EN) Aluminum tubular level with reinforced profile (1.8 mm). Accuracy: 0.5 mm/m. Bubble level with a 2 % incline indicator. Anti-slip handle and shock-absorbing rubber end caps. Magnetic option.
- (DE) Aluminium-Wasserwaage mit verstärktem Profil (1,8 mm). Genauigkeit: 0,5 mm/m. Libellen mit 2 % Neigungsmarkierung. Rutschfeste Grifföffnung und stoßdämpfende Endkappen. Magnetische Ausführung erhältlich.

NIVEL TUBULAR CON REGLA		REF.	cm						
77060	60	3	0,5 mm / m	Alu.	Caja	1	7290100847428		
77080	80	3	0,5 mm / m	Alu.	Caja	1	7290100847435		
77060M	60	3	0,5 mm / m	Alu.	Caja	1	7290100850978		

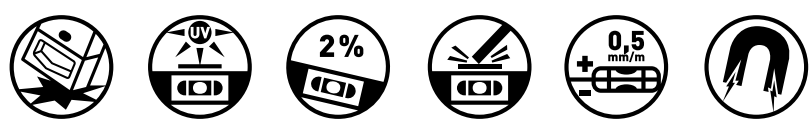

→ Ref. 77060M



- (ES) Nivel tubular de aluminio con 3 burbujas acrílicas de alta resistencia. Incorpora una regla para medición simultánea. Precisión: 0,5 mm/m. Burbujas con indicación de 2 % inclinación. Sistema antideslizante para nivelación en muros y topes de goma anti golpes. Opción magnética.
- (EN) Aluminum tubular level with 3 high-strength acrylic bubbles. Incorporates a ruler for simultaneous measurements. Accuracy: 0.5 mm/m. Bubble level with a 2 % incline indicator. Anti-slip system for wall leveling and shock-absorbing rubber end caps. Magnetic option.
- (DE) Aluminium-Wasserwaage mit 3 schlagfesten Acrylglas-Libellen. Mit integrierter Messleiste für gleichzeitige Messungen. Genauigkeit: 0,5 mm/m. Libellen mit 2 % Neigungsmarkierung. Rutschfestes System für die Wandnivellierung und stoßdämpfende Endkappen. Magnetische Ausführung erhältlich.

# NIVELES PROFESIONALES

PROFESSIONAL LEVELS

PROFI-WASSERWAAGEN

## NIVEL TUBULAR PRO

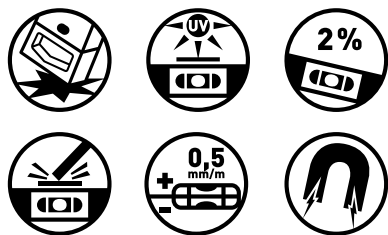

Ref. 77940M  
Ref. 77960M  
Ref. 77980M

REF.	cm							
77940	40	3	0,5 mm / m	Alu.	Caja	1	7290100849033	
77960	60	3	0,5 mm / m	Alu.	Caja	1	7290100849064	
77980	80	3	0,5 mm / m	Alu.	Caja	1	7290100849071	
779100	100	3	0,5 mm / m	Alu.	Caja	1	7290100849095	
779150	150	3	0,5 mm / m	Alu.	Caja	1	7290100853283	
779200	200	3	0,5 mm / m	Alu.	Caja	1	7290100853283	
77940M	40	3	0,5 mm / m	Alu.	Caja	1	7290100848005	
77960M	60	3	0,5 mm / m	Alu.	Caja	1	7290100848029	
77980M	80	3	0,5 mm / m	Alu.	Caja	1	7290100848036	



- (ES) Nivel tubular de aluminio con 3 burbujas acrílicas de alta resistencia. Precisión: 0,5 mm/m. Burbujas con indicación de 2 % inclinación. Sistema antideslizante para nivelación en muros y topes de goma anti golpes. Opción magnética.
- (EN) Aluminum tubular level with 3 high-strength acrylic bubbles. Accuracy: 0.5 mm/m. Bubbles with 2 % inclination indication. Anti-slip system for wall leveling and shock-absorbing rubber end caps. Magnetic option.
- (DE) Aluminium-Wasserwaage mit 3 schlagfesten Acrylglas-Libellen. Genauigkeit: 0,5 mm/m. Libellen mit 2 % Neigungsmarkierung. Rutschfestes System für die Wandnivellierung und stoßdämpfende Endkappen. Magnetische Ausführung erhältlich.

## NIVEL TUBULAR PRO

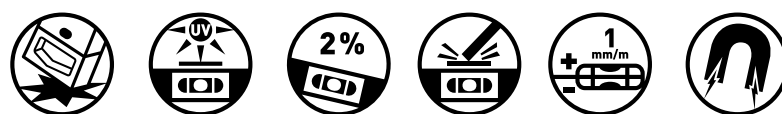

REF.	cm							
23060M	60	3	1 mm / m	Aluminio	Caja	1	8421411014837	
23080M	80	3	1 mm / m	Aluminio	Caja	1	8421411014844	
23100M	100	3	1 mm / m	Aluminio	Caja	1	8421411014851	
23150M	150	3	1 mm / m	Aluminio	Caja	1	8421411014875	



- (ES) Nivel tubular magnético de aluminio con 3 burbujas acrílicas de alta resistencia. Precisión: 1 mm / m. Burbujas con indicación de 2 %. Inclinación y base fresada. Sistema antideslizante para nivelación en muros y topes anti golpes.
- (EN) Aluminum magnetic tubular level with 3 high-strength acrylic bubbles. Accuracy: 1 mm / m. Bubbles with 2 % gradient indication. Milled incline and base. Non-slip system for wall leveling and anti-shock stops.
- (DE) Magnetische Aluminium-Wasserwaage mit 3 schlagfesten Acrylglas-Libellen. Genauigkeit: 1 mm / m. Libellen mit 2 % Neigungsmarkierung. Gefräste Auflagefläche. Rutschfestes System für die Wandnivellierung und stoßdämpfende Endkappen.

# NIVELES PROFESIONALES

PROFESSIONAL LEVELS

PROFI-WASSERWAAGEN



NIVEL TUBULAR ALA DE AVIÓN	REF.	cm						
----------------------------	------	----	--	--	--	--	--	--



73040	40	2	0,5 mm / m	Alu.	Caja	1	7290100852378
73060	60	2	0,5 mm / m	Alu.	Caja	1	7290100846827
73080	80	2	0,5 mm / m	Alu.	Caja	1	7290100847558



- (ES) Nivel ala de avión de aluminio con 2 burbujas acrílicas de alta resistencia. Precisión: 0,5 mm/m. Con Galgas para verificar el diámetro de las brocas.
- (EN) Aluminum trapezoidal level with 2 high-strength acrylic bubbles. Accuracy: 0.5 mm/m. With gauges for checking drill bit diameter.
- (DE) Trapezförmige Aluminium-Wasserwaage mit 2 schlagfesten Acrylglas-Libellen. Genauigkeit: 0,5 mm/m. Mit Lochlehren zum Überprüfen von Bohrerdurchmessern.

NIVEL TRAPEZOIDAL PROFESIONAL	REF.	cm						
-------------------------------	------	----	--	--	--	--	--	--



→ Ref. 17040M  
Ref. 17050M  
Ref. 17060M

17040	40 cm	2	0,5 mm / m	Alu.	Caja	1	8421411012284
17050	50 cm	2	0,5 mm / m	Alu.	Caja	1	8421411012291
17060	60 cm	2	0,5 mm / m	Alu.	Caja	1	8421411012307
17040M	40 cm	2	0,5 mm / m	Alu.	Caja	1	8421411013045
17050M	50 cm	2	0,5 mm / m	Alu.	Caja	1	8421411013052
17060M	60 cm	2	0,5 mm / m	Alu.	Caja	1	8421411013069



- (ES) Nivel ala de avión de aluminio con 2 burbujas acrílicas de alta resistencia. Precisión: 0,5 mm/m. Opción magnética.
- (EN) Aluminum level trapezoidal 2 high-strength acrylic bubbles. Accuracy: 0.5 mm/m. Magnetic option.
- (DE) Trapezförmige Aluminium-Wasserwaage mit 2 schlagfesten Acrylglas-Libellen. Genauigkeit: 0,5 mm/m. Magnetische Ausführung erhältlich.

MINI NIVEL DE ALUMINIO	REF.	cm						
------------------------	------	----	--	--	--	--	--	--



80245S	24,5 cm	3	1 mm / m	Alu.	Caja	1	8421411020357
--------	---------	---	----------	------	------	---	---------------



- (ES) Mini nivel de aluminio con 3 burbujas acrílicas de alta resistencia. Precisión: 1 mm/m.
- (EN) Mini aluminum level with 3 high-strength acrylic bubbles. Accuracy: 1 mm/m.
- (DE) Mini-Wasserwaage aus Aluminium mit 3 schlagfesten Acrylglas-Libellen. Genauigkeit: 1 mm/m.

# NIVELES PROFESIONALES

PROFESSIONAL LEVELS

PROFI-WASSERWAAGEN

## NIVEL RECTANGULAR

REF.	cm							
16040	40	2	0,5 mm / m	Alu.	Caja	1	8421411024232	
16060	60	2	0,5 mm / m	Alu.	Caja	1	8421411013625	
16080	80	2	0,5 mm / m	Alu.	Caja	1	8421411013632	
16100	100	2	0,5 mm / m	Alu.	Caja	1	8421411013649	



- (ES) Nivel rectangular de fundición de aluminio con 2 burbujas acrílicas, horizontal y vertical para facilitar la medición. Precisión: 0,5 mm/m.
- (EN) Rectangular aluminum casting level with 2 acrylic bubbles, horizontal and vertical for easy measurements. Accuracy: 0.5 mm/m.
- (DE) Rechteckige Wasserwaage aus Aluminiumguss mit 2 Acrylglas-Libellen, horizontal und vertikal, für einfache Messungen. Genauigkeit: 0,5 mm/m.

## MINI NIVEL TUBULAR MAGNÉTICO

REF.	cm						
77925	25	3	0,5 mm / m	Alu.	Caja	1	8421411025468

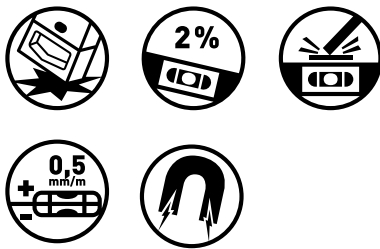

- (ES) Mini nivel profesional de 25 cm, 3 burbujas acrílicas de alta resistencia a los golpes. Base magnética fresada, parte superior acanalada en V. Precisión: 0,5 mm/m.
- (EN) Professional 25 cm mini level with 3 high-strength acrylic bubbles, shock-resistant. Milled magnetic base, top side with V-groove. Accuracy: 0.5 mm/m.
- (DE) Professionelle Mini-Wasserwaage mit 25 cm Länge, mit 3 schlagfesten Acrylglas-Libellen. Gefräste magnetische Auflagefläche, obere Seite mit mit V-Nut. Genauigkeit: 0,5 mm/m.

## NIVEL TORPEDO PLUS ABS

REF.	cm						
22730	23	3	0,5 mm / m	Plástico	Caja	1	7396320001265



- (ES) Nivel torpedo en plástico ABS, 3 burbujas cilíndricas, incluyendo: horizontal, vertical y 45°. Con base magnética y toques de goma anti golpes. Precisión: 0,5 mm.
- (EN) ABS plastic torpedo level with 3 cylindrical bubbles, including: horizontal, vertical, and 45°. With magnetic base and shock-resistant rubber end caps. Accuracy: 0.5 mm/m.
- (DE) Wasserwaage Torpedo aus ABS, mit 3 Röhrentlibellen: horizontal, vertikal und 45°. Mit magnetischer Auflagefläche und stoßfesten Endkappen. Genauigkeit: 0,5 mm/m.

# NIVELES PROFESIONALES

PROFESSIONAL LEVELS

PROFI-WASSERWAAGEN



MINI NIVEL PROFESIONAL 2 BURBUJAS	REF.	cm						
-----------------------------------	------	----	--	--	--	--	--	--

77110 10 2 0,5 mm / m Alu. Caja 1 7290100851920



- (ES) Mini nivel profesional de 10 cm, 2 burbujas acrílicas de alta resistencia a los golpes. Base magnética fresada, acanalada en V. Precisión: 0,5 mm/m.
- (EN) Professional 10 cm mini level with 2 high-strength acrylic bubbles, shock-resistant. Milled magnetic base with V-groove. Accuracy: 0.5 mm/m.
- (DE) Professionelle Mini-Wasserwaage mit 10 cm Länge, mit 2 schlagfesten Acrylglas-Libellen. Gefräste magnetische Auflagefläche mit V-Nut. Genauigkeit: 0,5 mm/m.

MINI NIVEL PROFESIONAL 1 BURBUJA	REF.	cm						
----------------------------------	------	----	--	--	--	--	--	--

77910 10 1 0,5 mm / m Alu. Caja 1 8421411025475



- (ES) Mini nivel profesional de 10 cm, 1 burbuja acrílicas de alta resistencia a los golpes. Base magnética. Precisión: 0,5 mm/m.
- (EN) Professional 10 cm mini level with 1 high-strength acrylic bubble, shock-resistant. Magnetic base. Accuracy: 0.5 mm/m.
- (DE) Professionelle Mini-Wasserwaage mit 10 cm Länge, mit 1 schlagfesten Acrylglas-Libelle. Magnetische Auflagefläche. Genauigkeit: 0,5 mm/m.

MINI NIVEL MAGNÉTICO	REF.	cm						
----------------------	------	----	--	--	--	--	--	--

440 10 2 2 mm / m Plástico Caja 1 8421411013670



- (ES) Mini nivel magnético de 2 burbujas acrílicas de alta resistencia a los golpes. Precisión: 2 mm/m. Incluye colgador.
- (EN) Mini magnetic level with 2 high-impact acrylic bubbles. Accuracy: 2 mm/m. Includes a hanger.
- (DE) Mini-Wasserwaage mit magnetischer Auflagefläche, mit 2 schlagfesten Acrylglas-Libellen. Genauigkeit: 2 mm/m. Inklusive Aufhänger.



# NIVELES PROFESIONALES

PROFESSIONAL LEVELS

PROFI-WASSERWAAGEN

## NIVEL TUBULAR



↓  
Ref. 27040M  
Ref. 27050M  
Ref. 27060M  
Ref. 27200M

- (ES) Nivel tubular de Aluminio con 3 burbujas acrílicas de alta resistencia a los golpes. Precisión: 0,1 mm/m. Opción magnética.
- (EN) Aluminum tubular level with 3 high-strength acrylic bubbles, shock-resistant. Accuracy: 0.1 mm/m. Magnetic option.
- (DE) Aluminium-Wasserwaage mit 3 schlagfesten Acrylglas-Libellen. Genauigkeit: 0,1 mm/m. Magnetische Option.

REF.	cm					
27030	30	3	1 mm / m	Alu.	Caja	1 8421411008492
27040	40	3	1 mm / m	Alu.	Caja	1 8421411008508
27050	50	3	1 mm / m	Alu.	Caja	1 8421411008515
27060	60	3	1 mm / m	Alu.	Caja	1 8421411008522
27080	80	3	1 mm / m	Alu.	Caja	1 8421411008539
27100	100	3	1 mm / m	Alu.	Caja	1 8421411010952
27120	120	3	1 mm / m	Alu.	Caja	1 8421411010969
27150	150	3	1 mm / m	Alu.	Caja	1 8421411010976
27040M	40	3	1 mm / m	Alu.	Caja	1 8421411010983
27050M	50	3	1 mm / m	Alu.	Caja	1 8421411010990
27060M	60	3	1 mm / m	Alu.	Caja	1 8421411011003
27200M	200	3	1 mm / m	Alu.	Caja	1 8421411013380



## NIVEL DIGITAL DE ALUMINIO

REF.	cm					
2010	60	2	2 mm / m	Alu.	Caja	1 8421411012321



- (ES) Nivel digital de aluminio con 2 burbujas acrílicas de alta resistencia a los golpes. Mide en cm y en grados. Precisión: 0,2 mm/m.
- (EN) Digital Aluminum Level with 2 High-Impact Acrylic Bubbles. Measures in centimeters and degrees. Accuracy: 0.2 mm/m.
- (DE) Digitale Aluminium-Wasserwaage mit 2 schlagfesten Acrylglas-Libellen. Misst in Zentimetern und Grad. Genauigkeit: 0,2 mm/m.

## GONIÓMETRO

REF.	cm					
33226	60	1	0,25 mm / m	Alu.	Caja	1 8421411004203

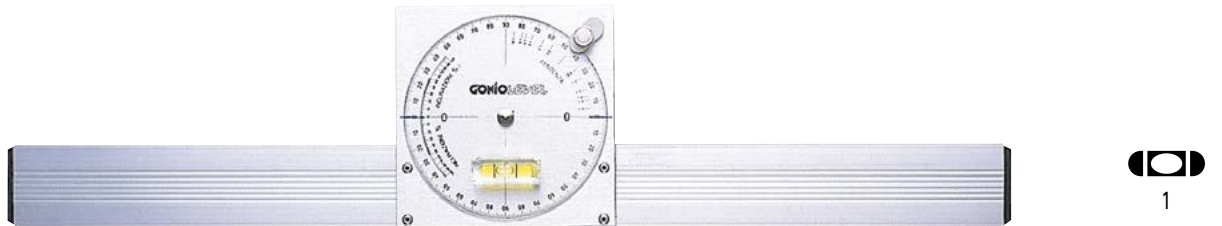

- (ES) Nivel goniométrico de aluminio con 1 burbuja acrílica de alta resistencia a los golpes. Determina inclinaciones y pendientes. Precisión: 0,25 mm/m.
- (EN) Aluminum Goniometric Level with 1 High-Impact Acrylic Bubble. Determines inclinations and slopes. Accuracy: 0.25 mm/m.
- (DE) Winkel-Wasserwaage aus Aluminium mit 1 schlagfesten Acrylglas-Libelle. Ermittelt Neigungen und Steigungen. Genauigkeit: 0,25 mm/m.

# ESCUADRAS + REGLA-NIVEL

SQUARES + RULER-LEVEL

WASSERWAAGE



## ESCUADRA ALUMINIO DIGITAL

REF. cm   
490045 40 2 0,5 mm / m Alu. Caja 1 8421411017425



- (ES) Escuadra goniómetro digital de aluminio con 2 burbujas acrílicas.
- (EN) Digital aluminum goniometer with 2 acrylic bubbles.
- (DE) Digitales Winkelmessgerät aus Aluminium mit 2 Acrylglas-Libellen.

## ESCUADRA ALUMINIO ANALÓGICA

REF. cm   
480000 48 2 0,5 mm / m Alu. Caja 1 8421411012314



- (ES) Escuadra aluminio analógica. Capacidad 0-220°.
- (EN) Digital aluminum goniometer with 2 acrylic bubbles.
- (DE) Digitales Aluminium-Goniometer mit 2 Acrylblasen.

## REGLA NIVEL APLANADOR

REF. cm   
SC03 200 2 1 mm / m Alu. Caja 1 8421411013434



- (ES) Regla-nivel-aplanador de aluminio con 2 burbujas acrílicas de alta resistencia a los golpes. Precisión: 1 mm/m.
- (EN) Aluminum Ruler-Level-Flattener with 2 High-Impact Acrylic Bubbles. Accuracy: 1 mm/m.
- (DE) Waag-/Nivellierlatte aus Aluminium mit 2 schlagesten Acrylglas-Libellen. Genauigkeit: 1 mm/m.

# NIVELES STAR Y OTROS ACCESORIOS DE NIVELACIÓN

STAR LEVELS AND OTHER LEVELLING ACCESORIES

STAR-NIVEAUS UND ANDERE NIVELLIERZUBEHÖR

## NIVEL TRAPEZOIDAL DE BRICOLAJE



REF.	cm						
15040	40	2	1 mm/m	Alu.	Caja	1	8421411007228
15050	50	2	1 mm/m	Alu.	Caja	1	8421411007235
15060	60	2	1 mm/m	Alu.	Caja	1	8421411007242



- (ES) Nivel trapezoidal de aluminio con diseño ala de avión. Equipado con 2 burbujas acrílicas de alta resistencia a los golpes. Precisión: 1 mm/m.
- (EN) Aluminum Trapezoidal Level with Aircraft Wing Design. Equipped with 2 High-Impact Acrylic Bubbles. Accuracy: 1 mm/m.
- (DE) Trapezförmige Wasserwaage aus Aluminium. Ausgestattet mit 2 schlagfesten Acrylglas-Libellen. Genauigkeit: 1 mm/m.

## NIVEL TUBULAR DE BRICOLAJE



REF.	cm						
25030	30	2	1 mm/m	Alu.	Caja	1	8421411006344
25040	40	2	1 mm/m	Alu.	Caja	1	8421411006351
25050	50	2	1 mm/m	Alu.	Caja	1	8421411006368
25060	60	2	1 mm/m	Alu.	Caja	1	8421411006375
25080	80	2	1 mm/m	Alu.	Caja	1	8421411006382
25100	100	2	1 mm/m	Alu.	Caja	1	8421411009635



- (ES) Nivel tubular de aluminio con 2 burbujas acrílicas de alta resistencia a los golpes. Con topes de plástico. Precisión: 1 mm/m.
- (EN) Aluminum Tubular Level with 2 High-Impact Acrylic Bubbles. Equipped with plastic stops. Accuracy: 1 mm/m.
- (DE) Aluminium-Wasserwaage mit 2 schlagfesten Acrylglas-Libellen. Ausgestattet mit Kunststoffkappen. Genauigkeit: 1 mm/m.

## NIVEL TORPEDO MAGNÉTICO



REF.	cm						
TORPEDO 300	20	3	2 mm/m	Plástico	Caja	1	8421411011027



- (ES) Nivel torpedo con base magnética. Equipado con 3 burbujas acrílicas de alta resistencia a los golpes. Precisión: 2 mm/m.
- (EN) Mini magnetic level with 2 high-impact acrylic bubbles. Accuracy: 2 mm/m. Includes a hanger.
- (DE) Mini-Wasserwaage mit magnetischer Auflagefläche, mit 3 schlagfesten Acrylglas-Libellen. Genauigkeit: 2 mm/m.

# NIVELES STAR Y OTROS ACCESORIOS DE NIVELACIÓN

STAR LEVELS AND OTHER LEVELLING ACCESORIES

STAR-NIVEAUS UND ANDERE NIVELLIERZUBEHÖR



NIVEL PARA CUERDA	REF.	cm						
	340	8,5	1	2,5 mm / m	Plástico	Blíster	1	8421411013465



- (ES)** Nivel para cuerda con 1 burbuja acrílicas de alta resistencia a los golpes. Precisión: 2,5 mm/m.
- (EN)** String level with 1 high-impact acrylic bubble. Accuracy: 2.5 mm/m.
- (DE)** Schnurwasserwaage mit 1 schlagfesten Acrylglas-Libelle. Genauigkeit: 2,5 mm/m.

NIVEL CIRCULAR	REF.	cm						
	N032	4,9	1	2 mm / m	Plástico	Caja	1	8421411017333



- (ES)** Nivel circular multiusos con 1 burbuja acrílica de alta resistencia a los golpes. Diámetro 30 mm. Sensibilidad 30 arc / min. Precisión: 2 mm/m.
- (EN)** Multi-purpose circular level with 1 high-impact acrylic bubble. Diameter: 30 mm. Sensitivity: 30 arc/minute. Accuracy: 2 mm/m.
- (DE)** Multifunktions-Dosenlibelle mit 1 schlagfesten Acrylglas-Libelle. Durchmesser: 30 mm. Empfindlichkeit: 30 Bogenminuten. Genauigkeit: 2 mm/m.

RECAMBIO DE BURBUJAS	REF.	mm						
	B1	40 x 15 x 15 mm	1	0,5 mm / m	Caja	1	8421411009987	
	B2	35 x 15 x 15 mm	1	0,5 mm / m	Caja	1	8421411009994	
	B3	62 x 15 x 15 mm	1	0,5 mm / m	Caja	1	8421411010006	
	040	40 x 15 x 15 mm	1	2 mm / m	Caja	1	8421411008201	



B2



B1



040



B3

- (ES)** Burbuja de recambio para nivel con precisión 0,5 mm / m. La Ref. 040 es un mini nivel con llavero que tiene una precisión de 2 mm / m.
- (EN)** Replacement bubble for level with 0.5 mm/m accuracy. Ref. 040 is a mini level with a keychain that has 2 mm/m accuracy.
- (DE)** Ersatzlibelle für Wasserwaage mit einer Genauigkeit von 0,5 mm/m. Art.-Nr. 040 ist ein Mini-Wasserwaage mit Schlüsselanhänger, die eine Genauigkeit von 2 mm/m hat.







ROTULADOR DE TINTA INDELEBLE DE PUNTA MEDIA	REF.				
  3603	361	●	Caja	12	8421411008768
	362	●	Caja	12	8421411008775
	363	●	Caja	12	8421411008782
	3603	●●	Blister	1	8421411023990

5 mm

(ES) Rotulador de tinta indeleble de secado rápido. Disponible en color rojo, azul y negro.  
 (EN) Quick-drying indelible ink marker. Available in red, blue, and black.  
 (DE) Schnelltrocknender Permanentmarker. Erhältlich in den Farben Rot, Blau und Schwarz.

ROTULADOR DE TINTA INDELEBLE DE PUNTA FINA	REF.				
  7203	720	●	Caja	12	8008621014057
	721	●	Caja	12	8008621014071
	722	●	Caja	12	8008621014064
	7203	●●	Blister	1	8421411080733

1 mm

(ES) Rotulador de tinta indeleble de secado rápido. Disponible en color negro, azul, y rojo.  
 (EN) Quick-drying indelible ink marker. Available in red, blue, and black.  
 (DE) Schnelltrocknender Permanentmarker. Erhältlich in den Farben Schwarz, Blau und Rot.

EXPOSITOR MARCADORES SURTIDOS	REF.	Medidas			
	36057	150 x 300 x 150 mm	Caja	1	8421411023044

(ES) Expositor de 57 marcadores surtidos. Punta media y fina.  
 (EN) Desktop stand 57 assorted markers, medium and fine tip.  
 (DE) Produktständer mit 57 Permanentmarkern. Mittlere und feine Spitze.

COMPOSICIÓN / COMPOSITION / ZUSAMMENSETZUNG			
REF.	punta		Cantidad
361	media	●	6
362	media	●	9
363	media	●	12
722	fina	●	6
721	fina	●	6
720	fina	●	18
			<b>TOTAL = 57</b>

### ROTULADOR DE TINTA INDELEBLE DE PUNTA GUESA

REF.				
371	●	Caja	12	8421411008799
373	●	Caja	12	8421411008812



- ES Rotulador de tinta indeleble de secado rápido. Disponible en color rojo y negro.
- EN Quick-drying indelible ink marker. Available in red and black.
- DE Schnelltrocknender Permanentmarker. Erhältlich in den Rot und Schwarz.

### ROTULADOR CAP OFF

REF.				
681	● Cap Off	Caja	12	8008621012008
682	● Cap Off	Caja	12	8008621012015
683	● Cap Off	Caja	12	8008621012022



- ES Rotulador CAP OFF, puede estar sin capuchón 24 h. Disponible en color azul, negro y rojo.
- EN Marker CAP OFF, it can stay opened during 24 h. Available in blue, black, and red.
- DE CAP-OFF Marker, kann 24 Stunden ohne Kappe bleiben. Erhältlich in Blau, Schwarz und Rot.

### ROTULADOR PERMANENTE Y EXPOSITOR

REF.				
770	●	Caja	12	8421411022900
772	●	Caja	12	8421411022917
77044	● ●	Caja	1	3660447400053



- ES Rotulador permanente con punta extendida de 20 mm. Ideal para orificios. Disponible en color rojo y negro.
- EN Permanent marker with extended 20 mm tip. Ideal for holes. Available in red and black.
- DE Permanentmarker mit verlängerter Spitze von 20 mm. Ideal für Löcher. Erhältlich in Rot und Schwarz.



ROTULADOR PERMANENTE Y EXPOSITOR	REF.				
<p>78032</p>	782	●	Caja	12	8421411022887
	783	●	Caja	12	8421411022894
	78032	● ●	Caja	1	3660447400077

1,5 mm

- (ES) Rotulador permanente retráctil tipo bolígrafo. Disponible en color rojo y negro.
- (EN) Quick-drying indelible ink marker. Available in red and black.
- (DE) Einziehbarer Permanentmarker mit Druckknopf. Erhältlich in Rot und Schwarz.

MARCADOR Y MINAS DE RECAMBIO	REF.			
<p>4080</p> <p><b>NUEVO</b></p>	4080	Caja	24	8421411025376
	4081	Caja	24	8421411025383
	4082	Caja	24	8421411025390

- (ES) Portaminas marcador profesional y recambios de minas grafito en color negro, rojo y amarillo.
- (EN) Professional marker mechanical pencil and refill packs of graphite leads in black, red, and yellow.
- (DE) Professioneller Markierstift und Nachfüllpackungen mit Graphitminen in Schwarz, Rot und Gelb.

CAJA EXPOSITORA	REF.			
<p><b>NUEVO</b></p>	204080	Caja	1	8421411025406

- (ES) Expositor de 20 portaminas marcador y 20 estuches de minas de recambio.
- (EN) Countertop stand 20 marker mechanical pencils and 20 packs of refill leads.
- (DE) Produktständer mit 20 Markierstiften und 20 Packungen Ersatzminen.

### PORTAMINAS Y MINAS DE RECAMBIO

18700



18711



REF.	mm					
18700	135	--	Caja	10	8421411014639	
18701	115	●	Caja	10	8421411014646	
18703	115	●	Caja	10	8421411017432	
18705	115	●	Caja	10	8421411017449	
18711	115	●	Blister	10	8421411022795	

- (ES) Portaminas para minas de diámetro de 5,5 mm y recambios de minas de grafito en color negro, rojo y azul.
- (EN) Mechanical pencil for 5.5 mm leads and refill packs of graphite leads in black, red, and blue.
- (DE) Markierstift für 5,5 mm Minen und Nachfüllpackungen mit Graphitminen in Schwarz, Rot und Blau.

### LÁPIZ BICOLOR PUNTA GRUESA

824



823



REF.	mm					
824	175	● ●	Caja	12	8421411019603	
823	175	● ●	Caja	12	8008621016464	

- (ES) Lápiz bicolor rojo y azul. Disponible en diámetros de 3 y 5 mm.
- (EN) Red and blue two colored pencil. Available in diameters of 3 and 5 mm.
- (DE) Zweifarbiges Bleistift in Rot und Blau. Erhältlich in Durchmessern 3 und 5 mm.

### LÁPIZ TRIANGULAR BIG



REF.	mm				
1290	250	10 mm	Caja	1	8421411019573

- (ES) Lápiz triangular BIG, mas grueso, su forma triangular evita los desplazamientos accidentales. Disponible en diámetro de 10 mm.
- (EN) Triangular BIG pencil, thicker, its triangular shape prevents accidental displacement. Available in a diameter of 10 mm.
- (DE) Dreieck-Bleistift BIG, dickerer Stift mit dreieckiger Form, um versehentliches Abrutschen zu verhindern. Erhältlich mit einem Durchmesser von 10 mm.

### LÁPIZ DE GRAFITO TRIANGULAR CON MINA HB2

834



831



REF.	mm					
834	175	●	Triangular 10 mm	Caja	1	8008621006816
831	175	●	Hex + goma 6 mm	Caja	1	8008621000760

- (ES) Lápices profesionales de grafito de alta calidad con mina HB2.
- (EN) High-quality professional graphite pencils with HB2 lead.
- (DE) Hochwertige professionelle Bleistifte mit HB2-Mine.

LÁPICES PROFESIONALES		REF.	mm	Descripción			
180		180	180	De carpintero	Caja	144	8421411006542
		250	250	De carpintero	Caja	144	8421411006849
1690		3180	180	De carpintero	Blister	1	8421411006863
		3250	250	De carpintero	Blister	1	8421411006870
		255	250	Extra duro	Caja	144	8421411012352
		300	180	Bicolor (rojo y azul)	Caja	144	8421411007181
		3300	180	Bicolor (rojo y azul)	Blister	1	8421411010754
		6365	180	Para cristales	Caja	12	8421411014332
		1690	180	Superficies mojadas	Caja	12	8421411014325

3300

3250

(ES) Lápices de carpintero y lapices especiales. Disponibles en tamaños de 180 y 250 mm.

(EN) Carpenter and other special pencils. Available in sizes of 180 and 250 mm.

(DE) Zimmermannsstifte und Spezialstifte Erhältlich in Größen 180 und 250 mm.

TUBOS MARCADORES DE PINTURA INDELEBLE	REF.				
	590	○	Caja	10	8421411017685
	591	●	Caja	10	8421411017692
	592	●	Caja	10	8421411017708
	593	●	Caja	10	8421411017715
	595	●	Caja	10	8421411017722

(ES) Tubos marcadores de pintura indeleble de secado rápido. Disponible en color blanco, rojo, azul, negro y amarillo.

(EN) Tube of quick drying indelible paint. Available in white, red, blue, black, and yellow.

(DE) Wasserfester Tubenschreiber mit schnelltrocknender Tinte. Erhältlich in Weiß, Rot, Blau, Schwarz und Gelb.

TIZA COMÚN	REF.		Medidas	Grosor			
	341	○	80 mm	10 mm	Caja	12	8435019570411
	345	○	80 mm	10 mm	Caja	240	8421411008751

(ES) Tiza común de color blanco con un grosor de 10 mm.

(EN) Common white chalk with a thickness of 10 mm.

(DE) Gewöhnliche weiße Kreide mit einer Dicke von 10 mm.

TIZAS DE CERA	REF.	mm					
	795	111	13 mm	●	Caja	10	8421411008560
	796	111	13 mm	●	Caja	10	8421411008577
	797	111	13 mm	●	Caja	10	8421411009864
	7953	111	13 mm	●●	Blister	1	8421411080740

(ES) Tiza de cera de uso universal con un grosor de 13 mm. Disponible en azul, rojo y amarillo.

(EN) Wax crayon universal use with a thickness of 13 mm. Available in blue, red, and yellow.

(DE) Universal-Wachskreide mit einem Durchmesser von 13 mm. Erhältlich in Blau, Rot und Gelb.



### TIZAS PARA METALES



REF.	mm	Ø	Icon	Icon	Icon	Icon
790	100	10 mm	○	Caja	50	8421411008546
791	100	10 mm	○	Caja	12	8421411008553

- (ES) Tiza de color blanco para metales con un grosor de 10 mm. Esteatita.
- (EN) White chalk for metals with a thickness of 10 mm. Soapstone.
- (DE) Weiße Kreide für Metalle mit einem Durchmesser von 10 mm. Speckstein.

### PERFILÓMETRO DE PLÁSTICO



REF.	Medidas	Icon	Icon	Icon
72005	280 x 105 x 20 mm	Caja	1	8421411002513

- (ES) Perfilómetro de plástico.
- (EN) Plastic profilometer.
- (DE) Konturenlehre aus Kunststoff.

### LETRAS DE ALUMINIO

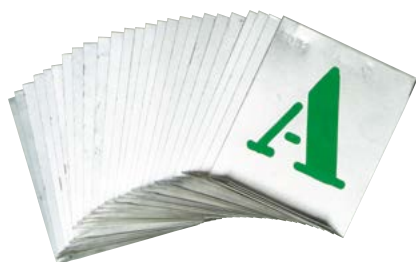

REF.	mm	Material	Icon	Icon	Icon
A030	30	Aluminio	Caja	1	8421411012932
A040	40	Aluminio	Caja	1	8421411012949
A050	50	Aluminio	Caja	1	8421411012956
A060	60	Aluminio	Caja	1	8421411012963
A080	80	Aluminio	Caja	1	8421411012970
A100	100	Aluminio	Caja	1	8421411012987



- (ES) Letras de aluminio.
- (EN) Aluminium letters.
- (DE) Aluminium-Buchstaben.

### NÚMEROS DE ALUMINIO



REF.	mm	Material	Icon	Icon	Icon
N030	30	Aluminio	Caja	1	8421411012871
N040	40	Aluminio	Caja	1	8421411012888
N050	50	Aluminio	Caja	1	8421411012895
N060	60	Aluminio	Caja	1	8421411012901
N080	80	Aluminio	Caja	1	8421411012918
N100	100	Aluminio	Caja	1	8421411012925

- (ES) Números de aluminio.
- (EN) Aluminium numbers.
- (DE) Aluminium-Nummern.

JUEGOS DE MARCAJE	REF.	Medida	Dimensiones				
	100.S2	2 mm	6 x 65 mm	Caja	1	8421411010297	
	100.S3	3 mm	6 x 65 mm	Caja	1	8421411010303	
	100.S4	4 mm	7 x 65 mm	Caja	1	8421411010310	
	100.S5	5 mm	8 x 65 mm	Caja	1	8421411010327	
	100.S6	6 mm	9 x 75 mm	Caja	1	8421411010334	
	100.S8	8 mm	11 x 76 mm	Caja	1	8421411010358	
	100.S10	10 mm	12 x 80 mm	Caja	1	8421411010365	
	100.S12	12 mm	14 x 80 mm	Caja	1	8421411010372	
		101.S2	2 mm	6 x 65 mm	Caja	1	8421411010396
		101.S3	3 mm	6 x 65 mm	Caja	1	8421411010402
		101.S4	4 mm	7 x 65 mm	Caja	1	8421411010419
		101.S5	5 mm	8 x 65 mm	Caja	1	8421411010426
101.S6		6 mm	9 x 75 mm	Caja	1	8421411010433	
101.S8		8 mm	11 x 76 mm	Caja	1	8421411010440	
101.S10		10 mm	12 x 80 mm	Caja	1	8421411010457	
101.S12		12 mm	14 x 80 mm	Caja	1	8421411010464	

- (ES) Juego para marcar de numeraciones (100.S) y abecedarios (101.S).
- (EN) Marks to stamp, numbers (100.S) and letters (101.S).
- (DE) Stempelsätze zum Stempeln von Nummern (100.S) und Buchstaben (101.S).





MARCADOR LYRA PARA AGUJEROS PROFUNDOS + EXPOSITOR	REF.				
	1181	●	Caja	10	4084900406731
	1191	●	Caja	10	4084900406717
	1201	●	Caja	10	4084900406892
	20118	● ● ●	Caja	1	4084900406762

1 MM

**ES** Marcador para agujeros profundos, perforaciones y puntos de difícil acceso. Permite escritura en cualquier superficie. Grosor 1 mm. Disponible en negro, rojo y azul.

**EN** Marker for deep holes, drillings, and hard-to-reach points. Allows writing on any surface. 1 mm thickness. Available in black, red, and blue.

**DE** Marker für tiefe Löcher, Bohrungen und schwer zugängliche Stellen. Ermöglicht das Schreiben auf jeder Oberfläche. 1 mm Stärke. Erhältlich in Schwarz, Rot und Blau.

ROTULADOR LYRA DE TINTA INDELEBLE	REF.				
	381	●	Caja	10	4084900650585
	382	●	Caja	10	4084900650578
	383	●	Caja	10	4084900650561

2-6 mm

**ES** Rotulador permanente indicado para el marcaje sobre cualquier superficie lisa y porosa, tinta de secado rápido y difícil de eliminar. Disponible en rojo, azul y negro.

**EN** Permanent suitable for marking on any surface smooth and porous, quick-drying ink and difficult to remove. Available in red, blue and black.

**DE** Permanentmarker zur Markierung auf jeder glatten und porösen Oberfläche, schnelltrocknende und schwer entfernbare Tinte. Erhältlich in Rot, Blau und Schwarz.

ROTULADOR LYRA DE TINTA INDELEBLE	REF.				
	391	●	Caja	10	4084900650622
	392	●	Caja	10	4084900650615
	393	●	Caja	10	4084900650608
	4050	●	Caja	10	4084900006979

**NUEVO**

1-4 mm    2-4 mm

**ES** Rotulador de tinta indeleble. Grosor 1-4 mm (rojo, azul y negro) y 2, 4 mm (blanco).

**EN** Marker with indelible ink. 1-4 mm thickness (red, blue and black) and 2.4 mm thickness (white).

**DE** Permanentmarker. 1-4 mm Dicke (Rot, Blau und Schwarz) und 2,4 mm Dicke (Weiß).



ROTULADOR LYRA DE TINTA PINTURA	REF.				
	460	○	Caja	10	4084900651582
	465	●	Caja	10	4084900651513
	467	●	Caja	10	4084900407011
	461	●	Caja	10	4084900406366
	462	●	Caja	10	4084900406397
	466	●	Caja	10	4084900406984
	463	●	Caja	10	4084900651599
	20469	○	Caja	10	4084900408025
	20460	Surtidos	Caja	1	4084900407912

- ES Rotulador industrial con punta de pincel, tinta pintura, indicado para el marcaje sobre cualquier superficie. Grosor 3 mm. Disponible en blanco, amarillo, naranja, rojo, azul, verde y negro.
- EN Industrial brush-tip marker with paint ink, suitable for marking on any surface. 3 mm thickness. Available in white, yellow, orange, red, blue, green, and black.
- DE Industriemarker mit Pinselspitze und Farbtinte, geeignet zum Markieren auf jeder Oberfläche. 3 mm Dicke. Erhältlich in Weiß, Gelb, Orange, Rot, Blau, Grün und Schwarz.

20469

20460

MARCADOR LYRA DRY PROFI GIANT	REF.			
<div style="text-align: center; color: white; background-color: red; border-radius: 50%; width: 40px; height: 40px; display: inline-block; margin-bottom: 10px;"> <b>NUEVO</b> </div>	4474	Caja	6	4084900008294
	4479	Caja	6	4084900008355
	204474	Caja	1	4084900008423

**12 MINAS EN CADA ESTUCHE**



- ES Marcador profesional de gran tamaño con alimentador automático, ideal para trabajos de construcción. Equipado con una mina de grafito de color negro apta para todas las superficies. De fácil afilado con el abrasivo incluido. La caja expositora incluye 12 marcadores y 9 estuches de minas de recambio.
- EN Large-sized professional marker with automatic feeder, ideal for construction work. Equipped with a black graphite lead suitable for all surfaces. Easily sharpened with the included abrasive. The display box includes 12 markers and 9 replacement lead cases.
- DE Großer professioneller Marker mit automatischem Zuführer, ideal für Bauarbeiten. Ausgestattet mit einer schwarzen Graphitmine, geeignet für alle Oberflächen. Einfach mit dem mitgelieferten Spitzer zu schärfen. Das Verkaufsdisplay enthält 12 Marker und 9 Ersatzminenbehälter.

204474



## MARCADOR LYRA DRY PROFI





REF.			
4099	Blister	1	4084900409121
4094	Caja	10	4084900408988
204094	Caja	1	4084900409039

- (ES) Marcador profesional con alimentador automático en un cilindro de acero de alta resistencia. Equipado con mina de grafito de color negro, amarillo y rojo, aptas para todas las superficies. Afilador integrado con una guía. La caja expositora incluye 20 marcadores y 12 estuches de minas de recambio.
- (EN) Professional marker with automatic feeder in a high-strength steel cylinder. Equipped with black, yellow, and red graphite leads, suitable for all surfaces. Integrated sharpener with a guide. The display box includes 20 markers and 12 replacement lead cases.
- (DE) Professioneller Marker mit automatischem Vorschub in einer Führung aus hochfestem Stahl. Ausgestattet mit schwarzen, gelben und roten Graphitminen, geeignet für alle Oberflächen. Integrierter Spitzer mit Führung. Das Verkaufsdisplay enthält 20 Marker und 12 Ersatzminenbehälter.

## MINAS DE RECAMBIO LYRA DRY



REF.		Dureza			
4091		Grafito 2B	Caja	10	4084900406809
4092		Grafito 2B	Caja	10	4084900406830
4093		Grafito 2B	Caja	10	4084900406861
4095		Grafito H	Caja	10	4084900408841

- (ES) Minas de recambio para marcadores Lyra Dry. Aptas para cualquier superficie. Tamaño 2,8 mm. La 4093 es resistente a chorros de agua.
- (EN) Replacement leads for Lyra Dry markers. Suitable for any surface. Size 2.8 mm. The 4093 is water-resistant.
- (DE) Ersatzminen für Lyra Dry Marker. Geeignet für jede Oberfläche. Größe 2,8 mm. Das Modell 4093 ist wasserfest.

## MARCADOR LYRA DRY PROFI CON LED



REF.			
4096	Blister	1	4084900409107

- (ES) Marcador profesional con alimentador automático en un cilindro de acero de alta resistencia. Afilador integrado con una guía y puntero LED integrado para una aplicación precisa en espacios poco iluminados.
- (EN) Professional marker with automatic feeder in a high-strength steel cylinder. Integrated sharpener with a guide and built-in LED pointer for precise application in low-light spaces.
- (DE) Professioneller Marker mit automatischem Vorschub in einer Führung aus hochfestem Stahl. Integrierter Spitzer mit Führung und LED-Pointer für präzise Anwendungen in schlecht beleuchteten Räumen.





## EXPOSITOR LYRA DRY PROFI





REF.			
20409	Caja	1	4084900406786

- (ES) Caja expositora con 20 marcadores (10 Lyra INK + 10 Lyra DRY PROFI) + 10 estuches de minas GRAPH 2B (Ref. 4092).
- (EN) Display box with 20 markers (10 Lyra INK + 10 Lyra DRY PROFI) + 10 GRAPH 2B lead cases (Ref. 4092).
- (DE) Verkaufsdisplay mit 20 Markern (10 Lyra INK + 10 Lyra DRY PROFI) + 10 GRAPH 2B Minenbehälter (Art.-Nr. 4092).





LÁPICES LYRA PROFESIONALES	REF.	mm			
	<b>33412</b>	240	Caja	12	4084900210277
	<b>33413</b>	240	Caja	12	4084900210338
	<b>334</b>	240	Caja	100	4084900210109



### 33412/334S





-  Lápiz 100 % Copiativo de tinta. Disponible en 12 o 100 unidades por caja.
-  100 % Ink Copying Pencil. Available in 12 or 100 units per box.
-  100 %-Kopierstift. Erhältlich in 12 oder 100 Stück pro Schachtel.



### 33413





-  Lápiz con 1/3 Copiativo de tinta y 2/3 Mina de grafito. Disponible en 12 por caja.
-  Pencil with 1/3 Ink Copying and 2/3 Graphite Lead. Available in 12 per box.
-  Stift mit 1/3 Kopierstift und 2/3 Graphitmine. Erhältlich in Schachteln mit jeweils 12 Stück.



### 334





-  Lápiz con 1/3 Copiativo de tinta y 2/3 Mina de grafito. Disponible en 100 por caja.
-  Pencil with 1/3 Ink Copying and 2/3 Graphite Lead. Available in 100 per box.
-  Stift mit 1/3 Kopierstift und 2/3 Graphitmine. Erhältlich in Schachteln mit jeweils 100 Stück.

LÁPICES LYRA DE SUPERFICIE LISA	REF.	mm			
	<b>6361</b>	240	Caja	12	408490006788
	<b>6362</b>	240	Caja	12	4084900104583
	<b>6363</b>	178	Caja	12	4084900260050

-  Lápices universales, triangulares, muy apropiados para la marcación sobre superficies lisas como vidrio, cerámica, losas o plástico. Fácil de eliminar.
-  Universal, triangular pencils, highly suitable for marking on smooth surfaces such as glass, ceramics, tiles, or plastic. Easy to erase.
-  Universelle, Dreieckbleistifte, besonders geeignet zum Markieren auf glatten Oberflächen wie Glas, Keramik, Fliesen oder Kunststoff. Leicht zu entfernen.

LÁPIZ LYRA DE SUPERFICIES MOJADAS	REF.	mm			
	<b>1695</b>	178	Caja	12	4084900260012

-  Lápiz para jardinero, marcaje resistente a la intemperie, ideal sobre superficies lisas y porosas al aire libre.
-  Gardener's pencil, weather-resistant marking, ideal for smooth and porous outdoor surfaces.
-  Gärtnerstift, wetterbeständige Kennzeichnung, ideal für glatte und poröse Außenflächen.

LÁPICES LYRA PROFESIONALES	REF.	mm			
 331	331	300	Caja	100	4084900210116
 333	333	300	Caja	100	4084900210093

**(ES)** Lápiz de albañil profesional. Forma ovalada, con mina extra resistente a la rotura, dureza especial y fácil de afilar. Ideal para marcar sobre piedra, hormigón y otras superficies rugosas.

**(EN)** Professional mason's pencil. Oval shape, with an extra break-resistant lead, special hardness, and easy to sharpen. Ideal for marking on stone, concrete, and other rough surfaces.





**(DE)** Professioneller Maurerstift. Oval geformt, mit einer besonders bruchfesten Mine, leicht zu spitzen. Ideal zum Markieren auf Stein, Beton und anderen rauen Oberflächen.

---

**(ES)** Lápiz de carpintero profesional. Forma ovalada, con mina extra resistente a la rotura, fácil de afilar. Ideal para marcar sobre madera.

**(EN)** Professional carpenter's pencil. Oval shape, with an extra break-resistant lead, easy to sharpen. Ideal for marking on wood.

**(DE)** Professioneller Zimmermannsstift. Oval geformt, mit einer besonders bruchfesten Mine, leicht zu spitzen. Ideal zum Markieren auf Holz.

LÁPICES LYRA PROFESIONALES	REF.	mm			
 4710	4710	178 mm	Caja	12	4084900120019
 4715	4715	178 mm	Caja	12	4084900271322

**(ES)** Lápices bicolor (rojo y azul). Afilados en ambos extremos, para marcaje fino. Ideal para marcar sobre losas, cerámicas o tuberías de metal y plástico, tanto de agua fría como caliente. Disponible en diámetro de 6,8 mm y 10 mm.

**(EN)** Bicolor pencils (red and blue). Sharpened at both ends, for fine marking. Ideal for marking on tiles, ceramics, or metal and plastic pipes, both for cold and hot water. Available in diameters of 6.8 mm and 10 mm.

**(DE)** Zweifarbige Bleistifte (rot und blau). An beiden Enden gespitzt, für feine Markierungen. Ideal zum Markieren von Fliesen, Keramik oder Metall- und Kunststoffrohren, sowohl für kaltes als auch heißes Wasser. Erhältlich in Durchmessern von 6,8 mm und 10 mm.

MINA DE GRAFITO LYRA	REF.	mm			
 1772	1772	95	Caja	1	4084900550298

**RESISTENTE AL AGUA**

**(ES)** Tiza de grafito para uso profesional. Resistente al agua en casi todas las superficies. Alta resistencia a la rotura. Diámetro de 12 mm.

**(EN)** Professional graphite chalk. Water-resistant on nearly all surfaces. High break resistance. Diameter of 12 mm.

**(DE)** Professionelle Grafitkreide. Wasserbeständig auf nahezu allen Oberflächen. Hohe Bruchfestigkeit. Durchmesser von 12 mm.

PORTAMINAS PROFESIONAL LYRA	REF.	mm			
 1766	1766	115	Caja	1	4084900630037

**12 mm**

**(ES)** Portaminas con cuerpo de plástico resistente ABS de excelente durabilidad. Ideal para tizas redondas o hexagonales de 11-12 mm de diámetro.

**(EN)** Mechanical pencil with a durable ABS plastic body for excellent durability. Ideal for round or hexagonal chalks with a diameter of 11-12 mm.

**(DE)** Druckbleistift mit einem robusten Gehäuse aus ABS-Kunststoff für ausgezeichnete Haltbarkeit. Ideal für runde oder sechseckige Kreiden mit einem Durchmesser von 11-12 mm.

SACAPUNTAS UNIVERSAL LYRA	REF.	Ø mm			
---------------------------	------	------	---	---	---



9496	10-17	Granel	1	4084900820599
------	-------	--------	---	---------------



- (ES) Sacapuntas para lápiz de carpintero y tizas de marcar con un diámetro de 10-17 mm. Permite un fácil y rápido afilado de lápices ovalados, triangulares y marcadores Lyra.
- (EN) Pencil sharpener for carpenter's pencils and marking chalk with a diameter of 10-17 mm. Enables easy and quick sharpening of oval, triangular, and Lyra markers.
- (DE) Minenspitzer für Zimmermannsstifte und Markierkreiden mit einem Durchmesser von 10-17 mm. Ermöglicht einfaches und schnelles Anspitzen von ovalen, dreieckigen Bleistiften und Lyra-Markierern.

TIZAS DE CERA LYRA	REF.	mm					
--------------------	------	----	---	---	---	---	---



798A	95	12 mm		Caja	12	4084900550861
798R	95	12 mm		Caja	12	4084900550892
798AM	95	12 mm		Caja	12	4084900550878





- (ES) Tiza de cera para uso profesional, indicada para el marcaje de metal, losas o piedra. Muy resistente.
- (EN) Chalk for professional use, suitable for marking metal, slabs, or stone. Very durable.
- (DE) Professionelle Wachskreide, geeignet für Markierungen auf Metall, Fliesen oder Stein. Lange haltbar.

TIZAS BASE ÓLEO LYRA	REF.	mm				
----------------------	------	----	---	---	---	---



7971	120		Caja	12	4084900550748
7972	120		Caja	12	4084900550731
7973	120		Caja	12	4084900550243
7975	120		Caja	12	4084900550755
7976	120		Caja	12	4084900550762

- (ES) Tiza en base óleo para un uso profesional, indicada para el marcaje de superficies rugosas, losas o piedra. Muy resistente.
- (EN) Oil-based chalk for professional use, suitable for marking rough surfaces, tiles, or stone. Very durable.
- (DE) Öl-basierte Kreide für den professionellen Gebrauch, geeignet zur Markierung von rauen Oberflächen, Fliesen oder Stein. Lange haltbar.

TIZA PARA NEUMÁTICOS	REF.	mm				
----------------------	------	----	---	---	---	---



680	100		Caja	12	4084900551288
780	100		Caja	12	4084900405444

- (ES) Tiza de cera universal para un uso profesional, indicada para el marcaje de neumáticos secos y húmedos, marcando además sobre casi todas las superficies y consistencias (aceitosas u oxidadas). Muy resistente.
- (EN) Universal wax chalk for professional use, suitable for marking dry and wet tires, marking on almost all surfaces and consistencies (oily or rusty). Very durable.
- (DE) Universelle Wachskreide für den professionellen Gebrauch, geeignet zur Markierung von trockenen und nassen Reifen, Markierung auf nahezu allen Oberflächen und für alle Konsistenzen (ölige oder rostige). Lange haltbar.



# MALLA Y CINTAS DE BALIZA

MESH AND BARRIER TAPES

ABSPERRNETZE UND -BÄNDER

## MALLA DE BALIZAMIENTO



REF.	Metros	cm			
50/1	50	100	Granel	1	8421411017661
60/1	50	100	Granel	1	8421411025413

- (ES) Mallas de balizamiento para vallado de señalización de 50 m. Disponibles en 80 g y 60 g.
- (EN) Safety fence 50 m roll. Available in 80 g and 60 g.
- (DE) Fangzäune für eine 50 m lange Umzäunung. Erhältlich in 80 g und 60 g.

## CINTAS DE BALIZA



REF.	Metros	cm			
39/4	200	7	Caja	1	8421411008072
40/10	250	10	Granel	1	8421411006269

- (ES) Cintas de baliza en plástico bicolor rojo/blanco. Disponibles en 250 y 200 m.
- (EN) Bicolor red/white plastic beacon tapes. Available in 250 and 200 m.
- (DE) Zweifarbige Kunststoff-Absperrbänder in Rot-Weiß. Erhältlich in 250 und 200 m.

## CINTA DE BALIZA ADHESIVA



REF.	Metros	cm			
39/6	200	8	Caja	1	8421411012666



- (ES) Cintas de baliza en plástico bicolor amarillo/negro. Disponible en 200 m.
- (EN) Yellow/black bicolored plastic flagging tape. Available in 200 m.
- (DE) Zweifarbige Kunststoff-Absperrbänder in Gelb/Schwarz. Erhältlich in 200 m.

## CINTAS DE BALIZA ADHESIVA

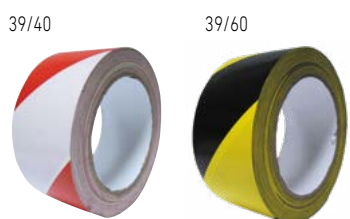

REF.	Metros	cm			
39/40	66	5	Caja	1	8421411020371
39/60	66	5	Caja	1	8421411020388



- (ES) Cintas de baliza adhesivas de 66 m en plástico bicolor rojo/blanco o amarillo/negro.
- (EN) Adhesive flagging tapes, 66 m in bicolored plastic red/white or yellow/black.
- (DE) Selbstklebende Absperrbänder, 66 m aus zweifarbigem Kunststoff in Rot/Weiß oder Gelb/Schwarz.

## CINTAS DE BALIZA ADHESIVA



REF.	Metros	cm			
5033	33	5	Caja	1	8421411022313
5036	33	5	Caja	1	8421411022320



- (ES) Cintas de baliza adhesivas de 33 m en plástico bicolor rojo/blanco o amarillo/negro.
- (EN) Adhesive flagging tapes, 33 m in bicolored plastic red/white or yellow/black.
- (DE) Selbstklebende Absperrbänder, 33 m aus zweifarbigem Kunststoff in Rot/Weiß oder Gelb/Schwarz.

CINTAS ANTIDESLIZANTES ADHESIVAS	REF.	Metros	cm			
	1918	18	1,9	Caja	1	8421411022269
	2518	18	2,5	Caja	1	8421411022276
	5018	18	5	Caja	1	8421411022283
	10018	18	10	Caja	1	8421411022290

**ADHESIVO**  
**ADHESIVE**  
**KLEBSTOFF**

(ES) Cintas antideslizantes y adhesivas de color negro. Resistentes al agua. Disponibles en 18 m.  
 (EN) Black anti-slip and adhesive tapes. Water-resistant. Available in 18 m.  
 (DE) Schwarze selbstklebende Antirutschbänder. Wasserfest. Erhältlich in 18 m.

CINTAS ANTIDESLIZANTES ADHESIVAS	REF.	Metros	cm				
	2516	18	2,5	● ●	Granel	1	8421411024546
	5016	18	5	● ●	Granel	1	8421411024553
	2517	18	2,5	●	Granel	1	8421411024560
	5017	18	5	●	Granel	1	8421411024577
	2519	18	2,5	○	Granel	1	8421411024584
	5019	18	5	○	Granel	1	8421411024591

**ADHESIVO**  
**ADHESIVE**  
**KLEBSTOFF**

(ES) Cintas antideslizantes y adhesivas de varios colores. Disponibles en 18 m.  
 (EN) Anti-slip and adhesive tapes in various colors. Available in 18 m.  
 (DE) Selbstklebende Antirutschbänder in verschiedenen Farben. Erhältlich in 18 m.

CONOS PLÁSTICO PVC	REF.	cm	Franjas blancas			
	880032	32	1	Caja	1	8421411002667
	880050	54	2	Granel	1	8421411002674
	900030	30	1	Granel	1	8421411020166
	900050	52	2	Granel	1	8421411020173

(ES) Conos en plástico de gran resistencia con franjas pintadas en blanco reflectantes. 8800 de PVC flexible. 9000 de Polietileno rígido. Disponibles en diferentes medidas.  
 (EN) High-strength plastic cones with reflective white painted stripes. 8800 made of flexible PVC. 9000 made of rigid polyethylene. Available in various sizes.  
 (DE) Robuste Kunststoffkegel mit reflektierenden weißen Streifen. 8800 aus flexiblem PVC. 9000 aus hartem Polyethylen. Erhältlich in verschiedenen Größen.





# PLOMADAS TRAZADORAS

CHALK LINES



SCHLAGSCHNURROLLER

## PLOMADAS TRAZADORAS



REF.	m	Material			
162	30	ABS	Caja	1	8421411009871





METAL

-  Plomadas trazadoras de metal o de ABS con cordel de 30 m.
-  Metal or ABS chalk lines with a 30 m cord.
-  Schlagschnurroller aus Metall oder ABS mit einem 30 m langen Schnur.

## SETS. TRAZADORA Y POLVO COLORANTE

REF.	m	Material			
1330	30	Bimaterial	Blister	1	8421411013915
1530	30	ABS-Bimaterial	Blister	1	8421411013359
190	30	ABS	Blister	1	8421411013076





-  Sets trazadora con polvo colorante. Disponible en estuche bimaterial, ABS + bimaterial o ABS. Todos ellos con cordel de 30 m. Opción magnética (Ref. 1330).
-  Chalk lines sets with colored powder. Available in two material, ABS + bimaterial, or ABS casing. All with a 30 m cord. Magnetic option (Ref. 1330).
-  Schlagschnur-Sets mit Farbpulver in verschiedenen Ausführungen. Erhältlich in einem 2K-Gehäuse, ABS + 2K oder ABS. Alle mit einer 30 m langen Schnur. Magnetische Ausführung erhältlich (Art.-Nr. 1330).

## TRAZADORA MAGNUM

REF.	m	Descripción			
175	50	ABS	Caja	1	8421411012628





-  Trazadora magnum en ABS con cordel de 50 m.
-  Magnum marking chalk liner in ABS with a 50 m cord.
-  Schlagschnurgerät Magnum aus ABS mit einem 50 m langen Schnur.

## RECAMBIO CORDEL

REF.	m			
130	30	Caja	1	8421411013106





-  Recambio de cordel de 30 m.
-  30 m cord replacement.
-  Ersatzschnur mit 30 m Länge.

## CORDEL TRAZADOR POLYPRO

REF.	m			
1100	100	Granel	1	8421411013144



-  Cordel trazador Polypro con cordel de 100 m. El soporte es de plástico.
-  Polypro marking cord with a 100 m cord. The holder is made of plastic.
-  Polypro-Schlagschnur mit 100 m langer Schnur. Der Halter ist aus Kunststoff.

# PLOMADAS

PLUMB BOBS

SENKLOTE AUS VERZINKTEM



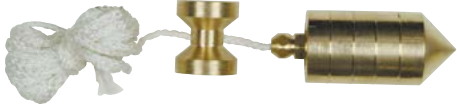

PLOMADA DE LATÓN	REF.	m	GR			
	1550	3	500	Blister	1	8421411013397

(ES) Plomada de latón con un peso de 500 g y cordel 3 m.  
 (EN) Brass plumb bob with a weight of 500 g and a 3 m cord.  
 (DE) Senklot aus Messing mit einem Gewicht von 500 g und einer 3 m Schnur.

PLOMADA DE HIERRO CALIBRADO	REF.	m	GR			
	100500	3	500	Blister	1	8421411012406
	100700	3	700	Blister	1	8421411005767

(ES) Plomadas de hierro calibrado zincado con cordel de 3 m. Distintos pesos.  
 (EN) Zinc-coated calibrated iron plumb bobs with a 3 m cord. Different weights.  
 (DE) Senklote aus verzinktem, geschliffenem Eisen mit 3 m Schnur. Unterschiedliche Gewichte.

PLOMADA DE HIERRO CALIBRADO ZINCADO	REF.	m	GR			
	100500M	3	500	Blister	1	8421411012413
	100700M	3	700	Blister	1	8421411009154
	1001000M	3	1000	Blister	1	8421411009161

 (ES) Plomadas magnéticas de hierro calibrado zincado con cordel 3 m. Distintos pesos.  
 (EN) Magnetic zinc-coated calibrated iron plumb bobs with a 3 m cord. Different weights.  
 (DE) Magnetische Senklote aus verzinktem, geschliffenem Eisen mit 3 m Schnur. Unterschiedliche Gewichte.

PLOMADA DE HIERRO CALIBRADO ZINCADO CON PLETINA	REF.	m	GR			
	200700	3	700	Blister	1	8421411012444
	2001000	3	1000	Blister	1	8421411012451

(ES) Plomadas de hierro calibrado zincado con pletina y cordel de 3 m. Pesos de 700 y 1000 g.  
 (EN) Zinc-coated calibrated iron plumb bobs with a plate and a 3 m cord. Weights of 700 and 1000 g.  
 (DE) Senklote auf verzinktem, geschliffenem Eisen mit Halteeisen und 3 m Schnur. Gewichte von 700 g und 1000 g.

PLOMADA DE ACERO	REF.	m	GR			
	1125	7,5	125	Blister	1	8421411013113

(ES) Plomadas de acero con cordel de 7,5 m.  
 (EN) Steel plumb bobs with a 7,5 m cord.  
 (DE) Stahl-Senklot mit einer 7,5 m Schnur.

# POLVOS Y SPRAYS

PULVER UND SPRAYS

PUDER UND SPRAYS

## PAREJA DE ANGULARES MAGNÉTICOS

REF.



500

Blister

1

8421411012390

- (ES) Pareja de angulares magnéticos con cordel.
- (EN) Pair of magnetic angles with cord.
- (DE) Paar magnetischer Winkel mit Schnur.

## POLVOS COLORANTES

REF.



P4B

100



Granel

1

8421411003565

P4BR

100



Granel

1

8421411013090

P224B

224



Granel

1

8421411009031

P336B

336



Granel

1

8421411013083

P1000B

1000



Granel

1

8421411006405

P1000BR

1000



Granel

1

8421411018408

P3500B

3500



Granel

1

8421411008041

P1336B

336



Granel

1

8421411020074

- (ES) Polvo colorante para trazadoras. Disponibles en varios tamaños y colores (rojo o azul). Opción anti-lluvia (Ref. P1336B).
- (EN) Color powder for marking. Available in various sizes and colors (red or blue). Rain-resistant option (Ref. P1336B).
- (DE) Farbpulver für Schlagschnurgeräte. Erhältlich in verschiedenen Größen und Farben (Rot oder Blau). Regenbeständige Ausführung (Art. Nr. P1336B).

## SPRAY FLUORESCENTE

REF.

ml



2810

500



Caja

12

8421411016312

2811

500



Caja

12

8421411016329

2812

500



Caja

12

8421411016336

2813

500



Caja

12

8421411016343

2814

500



Caja

12

8421411016350

2815

500



Caja

12

8421411016367

2816

500



Caja

12

8421411016374

2817

500



Caja

12

8421411016381

- (ES) Sprays de pinturas fluorescentes. Disponibles en distintos colores.
- (EN) Fluorescent paint sprays. Available in various colors.
- (DE) Leuchtfarbensprays. Erhältlich in verschiedenen Farben.

## SPRAY ZINC BRILLANTE

REF.

ml



9090

400

Caja

12

8421411019726

- (ES) Spray de zinc brillante para protección de zonas soldadas.
- (EN) Bright zinc spray for the protection of welded areas.
- (DE) Glanz-Zinkspray zum Schutz von geschweißten Bereichen.





# CUTTERS

## CUTTERS

### CUTTER

#### CUTTER METÁLICO 3 EN 1

REF.						
525	3	18 mm	Metal + goma antideslizante	Blister	10	8421411014684



- (ES) Cutter metálico 3 en 1: retorno automático de seguridad, bloqueo de cuchilla y corta fleje. Cuchilla SKH2 y mango bimaterial en metal combinado con goma antideslizante. Incluye 3 hojas de recambio de cuchilla trapezoidal en el mango Ref. 897.
- (EN) 3-in-1 Metal Cutter: automatic safety return, blade lock, and strap cutter. SKH2 blade and bimaterial handle made of metal combined with non-slip rubber. Includes 3 spare trapezoidal blade inserts in the handle Ref. 897.
- (DE) 3-in-1 Metallcutter: automatischer Rückzug, Klingerverriegelung und Bandschneider. SKH2-Klinge und 2K-Griff aus Metall und griffigem Gummi. Enthält 3 Ersatz-Trapezklingen im Griff Art.-Nr. 897.

#### CUTTER PLEGABLE PREMIUM

REF.						
505	3	18 mm	Metal + goma antideslizante	Blister	12	8421411014677



- (ES) Cutter metálico plegable. Permite fijar la parte de la cuchilla en 3 posiciones diferentes (90°, 135° y 180°) en función de las necesidades de corte del usuario. Incorpora una ranura para cortar cables, fleje plástico, etc. Equipado con una cuchilla negra de alta calidad en acero SKH2, trapezoidal de 18 mm con ultra afilado. Mango bimaterial en metal combinado con goma antideslizante. Incluye 3 hojas de recambio de cuchilla trapezoidal en el mango Ref. 897.
- (EN) Folding metal cutter. Allows fixing the blade part in 3 different positions (90°, 135°, and 180°) according to the user's cutting needs. Incorporates a slot for cutting wires, plastic strapping, etc. Equipped with a high-quality black SKH2 steel blade, 18mm trapezoidal with ultra-sharp edge. Bimaterial handle made of metal combined with non-slip rubber. Includes 3 spare trapezoidal blade inserts in the handle Ref. 897.
- (DE) Einklappbarer Metall-Cutter. Ermöglicht das Fixieren der Klinge in 3 verschiedenen Positionen (90°, 135° und 180°) je nach den Schneidanforderungen des Benutzers. Verfügt über einen Schlitz zum Schneiden von Drähten, Kunststoffbändern usw. Ausgestattet mit einer hochwertigen schwarzen, 18 mm breiten Trapezklinge aus SKH2-Stahl mit ultrascharfer Schneide. 2K-Griff aus Metall und griffigem Gummi. Enthält 3 Ersatz-Trapezklingen im Griff Art.-Nr. 897.

#### CUTTER PREMIUM CARPET

REF.						
885	2	18 mm	ABS	Blister	10	8421411024768



- (ES) Cutter con mango ABS. Guía de la hoja de acero inoxidable, de 1 mm de espesor, para garantizar una mayor resistencia. Incorpora en la base del mango una pestaña metálica multiusos: destornillador, abre latas, colocar moquetas, etc. Equipado con una cuchilla negra de alta calidad en acero SKH2, de 18 mm con ultra afilado. Con sistema de freno por rueda. Incluye 2 hojas de recambio Ref. 898.
- (EN) Cutter with ABS handle. Stainless steel blade guide, 1 mm thick, to ensure greater strength. Incorporates a multi-purpose metal tab on the handle base: screwdriver, can opener, carpet installation, etc. Equipped with a high-quality black SKH2 steel blade, 18mm with an ultra-sharp edge. With a wheel brake system. Includes 2 spare blades Ref. 898.
- (DE) Cutter mit ABS-Griff. Klingenföhrung aus Edelstahl, 1 mm dick, für eine höhere Festigkeit. Im Griff integriert ist ein Mehrzweck-Werkzeug: Schraubendreher, Dosenöffner, Teppichverlegung, usw. Ausgestattet mit einer 18 mm breiten hochwertigen schwarzen SKH2-Stahlklinge mit ultrascharfer Schneide. Mit Feststellrad. Enthält 2 Ersatzklingen Art.-Nr. 898.



# CUTTERS

CUTTERS

CUTTER



## CUTTER PREMIUM SOFT

REF. 18 mm ABS SOFT Blister 10 8421411024034



- ES Cutter con mango ABS acabado soft antideslizante, con agujero para colgar. Guía de la hoja de acero inoxidable. Equipado con una cuchilla negra de alta calidad en acero SKH2, de 18 mm con ultra afilado. Con sistema de autofreno. Incluye 2 hojas de recambio Ref. 898.
- EN Cutter with ABS handle. Stainless steel blade guide, 1 mm thick, to ensure greater strength. Incorporates a multi-purpose metal tab on the handle base: screwdriver, can opener, carpet installation, etc. Equipped with a high-quality black SKH2 steel blade, 18mm with an ultra-sharp edge. With a wheel brake system. Includes 2 spare blades Ref. 898.
- DE Cutter mit weichem, griffigem ABS-Griff und Bohrung zum Aufhängen. Klingenföhrung aus Edelstahl, 1 mm dick, für eine höhere Festigkeit. Ausgestattet mit einer 18 mm breiten hochwertigen schwarzen SKH2-Stahlklinge mit ultrascharfer Schneide. Mit Feststellrad. Enthält 2 Ersatzklingen Art.-Nr. 898.

## CUTTER PREMIUM AUTOLOCK

REF. 18 mm Fibra de vidrio + Elastollan Blister 10 8421411024041



- ES Cutter con mango de fibra de vidrio y Elastollan (resistente a la acetona), con agujero para colgar. Guía de la hoja de acero inoxidable. Equipado con una cuchilla negra de alta calidad en acero SKH2, de 18 mm con ultra afilado. Con sistema de auto freno. Incluye 1 hoja Ref. 898.
- EN Cutter with a fiberglass and Elastollan (acetone-resistant) handle, with a hanging hole. Stainless steel blade guide. Equipped with a high-quality black SKH2 steel blade, 18mm with an ultra-sharp edge. With a self-braking system. Includes 1 blade Ref. 898.
- DE Cutter mit Griff aus Glasfaser und Elastollan (acetonebeständig), mit Bohrung zum Aufhängen. Klingenföhrung aus Edelstahl. Ausgestattet mit einer 18 mm breiten hochwertigen schwarzen SKH2-Stahlklinge mit ultrascharfer Schneide. Mit automatischer Arretierung. Enthält 1 Klinge Art.-Nr. 898.

## CUTTER RUEDA PRO 25MM

REF. 25 mm Fibra de vidrio + Elastollan Blister 10 8421411024256



25 MM

- ES Cutter con mango de fibra de vidrio y Elastollan (resistente a la acetona), con agujero para colgar. Guía de la hoja de acero inoxidable. Equipado con una cuchilla negra de alta calidad en acero SKH2, de 25 mm con ultra afilado. Con sistema de freno por rueda. Incluye 1 hoja Ref. 896.
- EN Cutter with fiberglass and Elastollan (acetone-resistant) handle, with a hanging hole. Stainless steel blade guide. Equipped with a high-quality black SKH2 steel blade, 25 mm with an ultra-sharp edge. With a wheel brake system. Includes 1 blade Ref. 896.
- DE Cutter mit Griff aus Glasfaser und Elastollan (acetonebeständig), mit Bohrung zum Aufhängen. Klingenföhrung aus Edelstahl. Ausgestattet mit einer 25 mm breiten hochwertigen schwarzen SKH2-Stahlklinge mit ultrascharfer Schneide. Mit Feststellrad. Enthält 1 Klinge Art.-Nr. 896.

## CUTTER PREMIUM RUEDA

REF. 18 mm Fibra de vidrio + Elastollan Blister 10 8421411024058



- ES Cutter con mango de fibra de vidrio y Elastollan (resistente a la acetona), con agujero para colgar. Guía de la hoja de acero inoxidable. Equipado con una cuchilla negra de alta calidad en acero SKH2, de 18 mm con ultra afilado. Con sistema de freno por rueda. Incluye 1 hoja Ref. 898.
- EN Cutter with a fiberglass and Elastollan (acetone-resistant) handle, with a hanging hole. Stainless steel blade guide. Equipped with a high-quality black SKH2 steel blade, 18 mm with an ultra-sharp edge. With a wheel brake system. Includes 1 blade Ref. 898.
- DE Cutter mit Griff aus Glasfaser und Elastollan (acetonebeständig), mit Bohrung zum Aufhängen. Klingenföhrung aus Edelstahl. Ausgestattet mit einer 18 mm breiten hochwertigen schwarzen SKH2-Stahlklinge mit ultrascharfer Schneide. Mit Feststellrad. Enthält 1 Klinge Art.-Nr. 898.

# CUTTERS

## CUTTERS

### CUTTER

#### CUTTER METAL SKH2 30°







REF.						
890	1	9 mm	Metal	Blister	10	8421411024065



- (ES) Cutter con mango metálico, de gran comodidad de uso. Guía de la hoja de acero inoxidable. Equipado con una cuchilla negra de alta calidad en acero SKH2, de 9 mm con ultra afilado a 30° de ángulo. Con sistema de bloqueo deslizante. Incluye 1 hoja Ref. 899.
- (EN) Cutter with a metal handle, highly comfortable to use. Stainless steel blade guide. Equipped with a high-quality black SKH2 steel blade, 9mm with an ultra-sharp edge at a 30° angle. With a sliding lock system. Includes 1 blade Ref. 899.
- (DE) Cutter mit Metallgriff, äußerst komfortabel im Gebrauch. Klingenführung aus Edelstahl. Ausgestattet mit einer 9 mm breiten hochwertigen schwarzen SKH2-Stahlklinge mit ultrascharfer, in einem Winkel von 30° geschliffener Schneide. Mit Schiebearretierung. Enthält 1 Klinge Art.-Nr. 899.









#### CUTTER METAL CERAMIC

REF.						
888	1	18 mm	Metal	Blister	10	8421411024379



- (ES) Cutter con mango metálico y cuchilla cerámica. Con guía de acero inoxidable. Equipado con una cuchilla cerámica producida 100 % con óxido de zirconio, de 18 mm con ultra afilado. Con sistema de auto freno. Incluye 1 hoja Ref. 1088.
- (EN) Cutter with a metal handle and ceramic blade. With a stainless steel guide. Equipped with a ceramic blade made 100 % from zirconium oxide, 18mm with an ultra-sharp edge. With a self-braking system. Includes 1 blade Ref. 1088.
- (DE) Cutter mit Metallgriff und Keramik Klinge sowie Klingenführung aus Edelstahl. Ausgestattet mit einer 18 mm breiten ultrascharfen Keramik Klinge aus 100 % Zirkoniumoxid. Mit automatischer Arretierung. Enthält 1 Klinge Art.-Nr. 1088.

#### CUTTER CERÁMICO NO CONDUCTIVO

REF.						
886	1	9 mm	ABS	Blister	10	8421411024737
887	1	18 mm	ABS	Blister	10	8421411024744









**SIN RIESGO ELÉCTRICO**  
WITHOUT ELECTRICAL RISK  
OHNE ELEKTRISCHE GEFAHR



- (ES) Cutters no conductivos con mango ABS y cuchilla cerámica. Equipado con una cuchilla cerámica producida 100 % con óxido de zirconio, de 9 mm (la Ref. 886) y 18 mm (la Ref. 887) con ultra afilado. Con sistema de frenado tipo autolock. Incluye 1 hoja - la Ref. 886 tiene cuchilla con Ref. 1087 y la Ref. 887 tiene cuchilla con Ref. 1088.
- (EN) Non-conductive cutters with ABS handle and ceramic blade. Equipped with a ceramic blade made 100 % from zirconium oxide, 9 mm (Ref. 886) and 18 mm (Ref. 887) with an ultra-sharp edge. With an autolock braking system. Includes 1 blade - Ref. 886 has a blade with Ref. 1087, and Ref. 887 has a blade with Ref. 1088.
- (DE) Cutter mit Metallgriff und Keramik Klinge sowie Klingenführung aus Edelstahl. Ausgestattet mit einer 18 mm breiten ultrascharfen Keramik Klinge aus 100 % Zirkoniumoxid. Mit automatischer Arretierung. Enthält 1 Klinge Art.-Nr. 1088.

#### CUTTER PROFESIONAL METÁLICO

REF.						
818	1	18 mm	Metal	Blister	12	8421411020807
820	1	25 mm	Metal	Blister	12	8421411020814



818



820



- (ES) Cutter profesional metálico. Equipado con una cuchilla de acero SK5, de 18 mm (la Ref. 818) y de 25 mm (la Ref. 820) con ultra afilado. Con sistema de auto freno. Los dos cutters incluyen 1 hoja standard.
- (EN) Professional metal cutter. Equipped with an SK5 steel blade, 18 mm (Ref. 818) and 25 mm (Ref. 820) with an ultra-sharp edge. With a self-braking system. Both cutters include 1 standard blade.
- (DE) Professioneller Metall-Cutter. Ausgestattet mit einer ultrascharfen SK5-Stahl Klinge mit 18 mm Breite (Art.-Nr. 818) und 25 mm Breite (Art.-Nr. 820). Mit automatischer Arretierung. Beide Cutter enthalten 1 Standard Klinge.

# CUTTERS

CUTTERS

CUTTER



CUTTER CON RETORNO AUTOMÁTICO	REF.						
	803	2	18 mm	Metal	Blister	12	8421411008324
<p><b>ES</b> Cutter metálico de aleación ligera y de alta resistencia. Equipado con cuchillas trapezoidales situadas dentro del propio mango, de 18 mm con ultra afilado. Con sistema de apertura, freno y cierre por pulsador. Incluye 2 hojas de recambio Ref. 1083PRO.</p> <p><b>EN</b> Lightweight and highly durable metal cutter. Equipped with trapezoidal blades located within the handle itself, 18mm with an ultra-sharp edge. With a push-button opening, braking, and closing system. Includes 2 spare blades Ref. 1083PRO.</p> <p><b>DE</b> Hochbelastbarer Leichtmetall-Cutter. Ausgestattet mit 18 mm breiten ultrascharfen Trapezklingen, die sich im Griff befinden. Mit einem Öffnungs-, Arretier- und Verschlussystem per Druckknopf. Enthält 2 Ersatzklingen Art.-Nr. 1083PRO.</p>							

CUTTER METÁLICO	REF.						
	703	1	9 mm	Metal	Caja	24	8421411008997
<p><b>ES</b> Cutter metálico de alta resistencia. Equipado con una cuchilla, de 9 mm con ultra afilado. Con sistema de auto freno. Incluye 1 hoja standard.</p> <p><b>EN</b> High-strength metal cutter. Equipped with a 9 mm ultra-sharp blade. With a self-braking system. Includes 1 standard blade.</p> <p><b>DE</b> Hochfester Metall-Cutter. Ausgestattet mit einer 9 mm breiten ultrascharfen Klinge. Mit automatischer Arretierung. Enthält 1 Standardklinge.</p>							

CUTTER DE SEGURIDAD	REF.						
	966	1	18 mm	Metal	Caja	10	8421411014547
<p><b>ES</b> Cutter metálico de de seguridad. Mango metálico, equipado con una cuchilla, de 18 mm con ultra afilado. Con sistema de seguridad con retorno automático.</p> <p><b>EN</b> Security metal cutter. Equipped with an ultra-sharp 18 mm blade. With an automatic safety return system.</p> <p><b>DE</b> Sicherheits-Metall-Cutter. Metallgriff, ausgestattet mit einer 18 mm breiten ultrascharfen Klinge. Mit automatischem Rückzug.</p>							

CUTTER DE SEGURIDAD CON RETORNO AUTOMÁTICO	REF.						
  1 ←  2 →→→	866	1	18 mm	ABS+Elast	Blister	10	8421411024126
<p><b>ES</b> Cutter de seguridad, con mango ABS y Elastollan antideslizante, con agujero para colgar. Equipado con una cuchilla trapezoidal, de 18 mm con ultra afilado. Con sistema de seguridad con retorno automático. Permite el cambio de sentido de la hoja para ser usado por personas zurdas.</p> <p><b>EN</b> Security cutter with ABS handle and non-slip Elastollan, with a hanging hole. Equipped with an ultra-sharp 18mm trapezoidal blade. With an automatic safety return system. Allows for the change of the blade direction to be used by left-handed users.</p> <p><b>DE</b> Sicherheitscutter, mit Griff aus ABS und griffigem Elastollan, mit Bohrung zum Aufhängen. Ausgestattet mit einer 18 mm breiten trapezförmigen ultrascharfen Klinge. Mit automatischem Rückzug. Ermöglicht das Umdrehen der Klinge für die Verwendung durch Linkshänder.</p>							

# CUTTERS

## CUTTERS

### CUTTER

#### CUTTER CORTAFLEJE



REF.					
912	1	ABS+Elastollan	Blister	12	8421411016213

- (ES) Cutter especial para cortar fleje. Con mango ABS y Elastollan antideslizante, con agujero para colgar. Incluye 1 hoja Ref. 1912.
- (EN) Special cutter for cutting strapping. With ABS handle and non-slip Elastollan, with a hanging hole. Includes 1 blade Ref. 1912.
- (DE) Spezial-Cutter zum Schneiden von Kunststoffbändern. Mit Griff aus ABS und griffigem Elastollan sowie Bohrung zum Aufhängen. Ersatzklingen Art.-Nr. 1912.

#### CUTTER PROFESIONAL BIMATERIAL



REF.						
811	1	25 mm	ABS+Elast.	Blister	12	8421411011454

- (ES) Cutter con mango ABS y Elastollan antideslizante. Equipado con una cuchilla, de 25 mm con ultra afilado. Con sistema de freno por rueda. Incluye 1 hoja standard.
- (EN) Cutter with ABS handle and non-slip Elastollan. Equipped with an ultra-sharp 25 mm blade. With a wheel brake system. Includes 1 standard blade.
- (DE) Cutter mit Griff aus ABS und griffigem Elastollan. Ausgestattet mit einer 25 mm breiten ultrascharfen Klinge. Mit Feststellrad. Enthält 1 Standardklinge.

#### CUTTER PROFESIONAL BIMATERIAL



812

813

REF.						
812	1	18 mm	ABS+Elast.	Blister	12	8421411011461
813	2	18 mm	ABS+Elast.	Blister	12	8421411011478

- (ES) Cutters con mango ABS y Elastollan antideslizante. Equipados con una cuchilla, de 18 mm con ultra afilado. Con sistema de freno (la Ref. 813 tiene sistema de freno por rueda).
- (EN) Cutters with ABS handle and non-slip Elastollan. Equipped with an ultra-sharp 18 mm blade. With a brake system (Ref. 813 has a wheel brake system).
- (DE) Cutter mit Griff aus ABS und griffigem Elastollan. Ausgestattet mit einer ultrascharfen 18 mm breiten Klinge. Mit Arretiersystem (Art.-Nr. 813 hat ein Feststellrad).

#### CUTTER RECARGA AUTOMÁTICA



908

REF.						
908	8	18 mm	ABS+Elast.	Caja	24	8421411013489
908B	8	18 mm	ABS+Elast.	Blister	12	8421411023754



- (ES) Cutter con mango ABS y Elastollan antideslizante. Equipado con una cuchilla, de 18 mm con ultra afilado. Con sistema de auto freno. Incluyen 8 hojas de recambio en el mango. Disponible en Caja expositora de 24 unidades y blíster individual.
- (EN) Cutter with ABS and non-slip Elastollan handle. Equipped with an 18 mm ultra-sharp blade. With auto brake system. They include 8 replacement blades in the handle. Available in display box of 24 units and individual blister.
- (DE) Cutter mit Griff aus ABS und griffigem Elastollan. Ausgestattet mit einer ultrascharfen 18 mm breiten Klinge. Mit automatischer Arretierung. Enthält 8 Ersatzklingen im Griff. Erhältlich in einem Verkaufsdisplay mit 24 Stück und individueller Blisterverpackung.

# CUTTERS

CUTTERS

CUTTER





CUTTER RECARGA AUTOMÁTICA	REF.						
	915	5	18 mm	ABS+Elast.	Blister	24	8421411016220
							
							



- (ES) Cutter con mango ABS y Elastollan antideslizante. Equipados con una cuchilla, de 18 mm con ultra afilado. Con sistema de auto freno. Incluyen 5 hojas SK5.
- (EN) Cutter with ABS handle and non-slip Elastollan. Equipped with an ultra-sharp 18 mm blade. With a self-braking system. Includes 5 SK5 blades.
- (DE) Cutter mit Griff aus ABS und griffigem Elastollan. Ausgestattet mit einer ultrascharfen 18 mm breiten Klinge. Mit automatischer Arretierung. Enthält 5 SK5-Klingen.

CUTTER RECARGA AUTOMÁTICA	REF.						
	909	3	9 mm	ABS+Elast	Blister	36	8421411024133
							

- (ES) Cutter con mango ABS y Elastollan antideslizante. Equipados con una cuchilla, de 9 mm con ultra afilado. Con sistema de auto freno. Incluyen 3 hojas SK5.
- (EN) Cutter with ABS handle and non-slip Elastollan. Equipped with an ultra-sharp 9 mm blade. With a self-braking system. Includes 3 SK5 blades.
- (DE) Cutter mit Griff aus ABS und griffigem Elastollan. Ausgestattet mit einer ultrascharfen 9 mm breiten Klinge. Mit automatischer Arretierung. Enthält 3 SK5-Klingen.

CUTTER ABS	REF.						
603 	603	1	18 mm	ABS	Caja	12	8421411008980
503 	503	1	9 mm	ABS	Caja	36	8421411008973
403 	403	1	18 mm	ABS	Caja	12	8421411009888

- (ES) Cutters con mango ABS. Equipados con una cuchilla, de 9 o 18 mm (según modelo) con ultra afilado. Con sistema de auto freno. Incluye 1 hoja standard.
- (EN) Cutters with ABS handle. Equipped with an ultra-sharp blade, 9 mm or 18 mm (depending on the model). With a self-braking system. Includes 1 standard blade.
- (DE) Cutter mit ABS-Griff. Ausgestattet mit einer ultrascharfen Klinge mit 9 mm oder 18 mm Breite (je nach Modell). Mit automatischer Arretierung. Enthält 1 Standardklinge.

CUCHILLAS DE RECAMBIO PREMIUM SKH2	REF.		Material			
	896	25 mm	SKH2	Blister	10	8421411024263
	898	18 mm	SKH2	Caja	10	8421411024089
	899	9 mm	SKH2	Caja	10	8421411024072
	897	18 mm	SKH2	Caja	10	8421411024096
	1897	18 mm	SKH2	Caja	10	8421411024775

- (ES) Hojas de recambio de cuchillas en acero al carbono SKH2 de alta calidad. Color negro. Hoja ultra afilada, tiene un filo de 25 % más afilado para una menor resistencia en el corte. Disponibles en 9, 18 y 25 mm.
- (EN) High-quality carbon steel SKH2 replacement blades. Black color. Ultra-sharp blade, with a 25 % sharper edge for reduced cutting resistance. Available in 9, 18, and 25 mm.
- (DE) Hochwertige Ersatzklingen aus Kohlenstoffstahl SKH2. Schwarze Farbe. Ultrascharfe Klinge mit einer um 25 % schärferen Schneide, sodass beim Schneiden weniger Druck ausgeübt werden muss. Erhältlich in 9, 18 und 25 mm Breite.



# CUTTERS

CUTTERS

CUTTER

## CUCHILLAS DE RECAMBIO CERAMIC



REF.		Material			
1087	9 mm	Cerámica	Blíster	10	8421411024751
1088	18 mm	Cerámica	Blíster	10	8421411024386

- (ES) Hojas de recambio de cuchillas cerámicas. Color blanco. Hoja ultra afilada, se mantiene 11 veces más que en la cuchilla metálica. Disponibles en 9 y 18 mm.
- (EN) Replacement ceramic blade inserts. White color. Ultra-sharp blade, lasts 11 times longer than a metal blade. Available in 9 and 18 mm.
- (DE) Ersatz-Keramikklingen. Weiße Farbe. Ultrascharfe Klinge, hält 11 Mal länger als eine Metallklinge. Erhältlich in 9 und 18 mm Breite.

## CUCHILLAS DE RECAMBIO ACERO SKH2



REF.		Material			
1083PRO	18 mm	SKH2	Caja (10)	1	8421411013588
1083GPRO	18 mm	SKH2	Caja (5)	1	8421411013571
1025PRO	25 mm	SKH2	Caja (10)	1	8421411013564
1021PRO	18 mm	SKH2	Caja (10)	1	8421411013557
1011PRO	9 mm	SKH2	Caja (10)	1	8421411013540

- (ES) Hojas de recambio de cuchillas en acero al carbono SKH2 de alta calidad. De triple arista. Hoja ultra afilada. Disponibles en 9, 18 y 25 mm.
- (EN) High-quality triple-edge carbon steel SKH2 replacement blades. Ultra-sharp blade. Available in 9, 18, and 25 mm.
- (DE) Ersatzklingen aus hochwertigem SKH2 Kohlenstoffstahl. Drei Schneidkanten. Ultrascharfe Klinge. Erhältlich in 9, 18 und 25 mm Breite.

## CUCHILLAS DE RECAMBIO ESTÁNDAR

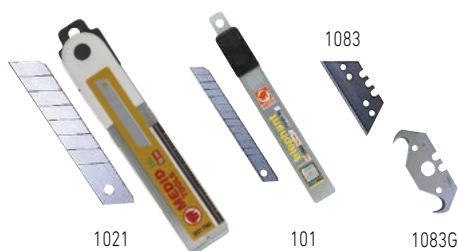

REF.		Material			
1083	18 mm	Caja (10)	1	8421411008331	
1083G	18 mm	Caja (10)	1	8421411010808	
1025	25 mm	Caja (10)	1	8421411011706	
1021	18 mm	Caja (10)	1	8421411002599	
1011	9 mm	Caja (10)	1	8421411002582	
1912	21 mm	Caja (10)	1	8421411016725	
2308	12 mm	Caja (10)	2	8421411021729	
1086	18 mm	Caja (10)	10	8421411024621	

TOP  
QUALITY

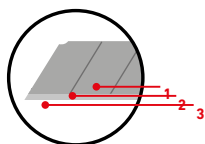

- (ES) Hojas de recambio de cuchillas de alta calidad. Varios diseños (standard, trapecoidales, gancho y rascavidrios). Disponibles en 9, 12, 18, 21 y 25 mm.
- (EN) High-quality replacement blade inserts. Various designs (standard, trapezoidal, hook, and scraper). Available in 9, 12, 18, 21, and 25 mm.
- (DE) Hochwertige Ersatzklingen. Verschiedene Designs (Standard, Trapezform, Haken und Schaber). Erhältlich in 9, 12, 18, 21 und 25 mm Breite.

# HERRAMIENTAS DE CORTE

CUTTING TOOLS

SCHNEIDEWERKZEUGE



## NAVAJA ELECTRICISTA

REF.		Material			
410	9 mm	ABS	Blister	1	8421411014714



- (ES) Navaja para electricista de 9 mm con mango en ABS.
- (EN) 9 mm electrician's knife with ABS handle.
- (DE) Elektriker-Messer mit 9 mm breiter Klinge und ABS-Griff.

## CORTAVIDRIOS MANGO MADERA

REF.	Material			
CV100	Madera	Caja	1	4010122100003
CV200	Madera	Blister	12	8421411006627



- (ES) Cortavidrios con mango madera. La Ref. CV100 es de la marca Silberschnitt.
- (EN) Glass cutter with a wooden handle. The Ref. CV100 is from the Silberschnitt brand.
- (DE) Glasschneider Silberschnitt mit Holzgriff. Die Art.-Nr. CV100 ist von der Marke Silberschnitt.

## RASCAVIDRIOS

REF.		Material			
208	18 mm	Plástico	Granel	36	8421411011010



- (ES) Rascavidrios de plástico.
- (EN) Plastic scraper.
- (DE) Kunststoff-Glasschaber.

## RASCADOR PARA VITROCERÁMICA

REF.		Material				
308	1	18 mm	ABS	Blister	12	8421411013601



- (ES) Rascador para vitrocerámica en plástico ABS de alta resistencia.
- (EN) High-strength ABS plastic scraper for ceramic glass.
- (DE) Widerstandsfähiger ABS-Glasschaber für Glaskeramik.

## RASCADOR PROFESIONAL PREMIUM

REF.		Material				
408	1	100 mm	Bimaterial	Blister	10	8421411021408



- (ES) Rascador con mango bimaterial, ergonómico y antideslizante. Para cuchillas anchas (100 mm). El mango contiene 2 hojas de recambio en el interior. Incluye cuchilla negra de alta calidad en acero SKH2 (Ref. 2408).
- (EN) Scraper with bimaterial, ergonomic, and non-slip handle. For wide blades (100 mm). The handle contains 2 replacement blades inside. Includes high-quality black blade in SKH2 steel (Ref. 2408).
- (DE) Schaber mit ergonomischem und rutschfestem 2K-Griff. Für breite Klingen (100 mm). Der Griff enthält 2 Ersatzklingen im Inneren. Darunter eine hochwertige schwarze Klinge aus SKH2-Stahl (Art.-Nr. 2408).

## RASCADOR PROFESIONAL ALUMINIO

REF.		Material				
508	1	100 mm	Alu+PVC	Blister	10	8421411024836



- (ES) Rascador de aluminio con PVC en el mango para un tacto agradable. Para cuchillas anchas (100 mm). Su recambio de cuchilla es la Ref. 2508.
- (EN) Aluminum scraper with PVC on the handle for a pleasant feel. For wide blades (100 mm). Its replacement blade is Ref. 2508.
- (DE) Aluminiumschaber mit PVC-Griff für besseren Halt. Für breite Klingen (100 mm). Die Ersatzklinge hat die Art.-Nr. 2508.

# HERRAMIENTAS DE CORTE

CUTTING TOOLS

SCHNEIDWERKZEUGE

## CUCHILLAS DE RECAMBIO RASCADOR PRO/CUCHILLA



REF.				
2408	100 mm	Caja	10	8421411024782
2508	100 mm	Caja	10	8421411024843

- (ES) Cuchillas de recambio de alta calidad. La Ref. 2408 es de acero SKH2 con ultra afilado. Ancho de 100 mm.
- (EN) High-quality replacement blades. Ref. 2408 is made of ultra-sharp SKH2 steel. Width of 100 mm.
- (DE) Hochwertige Ersatzklingen. Art.-Nr. 2408 besteht aus ultrascharfem SKH2-Stahl. Breite von 100 mm.

## ESCOFINA METÁLICA



REF.		Material			
504	140 mm	Metal+Acero	Blister	1	8421411024850
506	140 mm	ABS+Acero	Blister	1	8421411024867
2504	140 mm	Acero	Caja	1	8421411024874

- (ES) Escofinas con cuerpo metálico (Ref. 504) o ABS (Ref. 506). Fácil sistema de cambio de hojas. Para pladur o madera. Con una hoja hecha de acero de 140 mm (Ref. 2504).
- (EN) Rasp with metal body (Ref. 504) or ABS (Ref. 506). Easy blade replacement system. For plasterboard or wood. With a 140 mm steel blade (Ref. 2504).
- (DE) Raspeln mit Griff aus Metall (Art.-Nr. 504) oder ABS (Art.-Nr. 506). Einfacher Klingenwechsel. Für Gipskarton oder Holz. Mit einer 140 mm Stahlklinge (Art.-Nr. 2504).

## SIERRA PARA PLADUR



875



877

REF.		Material			
875	500 mm	ABS + TPR + Acero	Blister	1	8421411024904
876	600 mm	ABS + TPR + Acero	Blister	1	8421411024911
877	150 mm	ABS + TPR + Acero	Blister	1	8421411012079

- (ES) Sierras para pladur hechas de acero al magnesio. Mango ergonómico bicolor en ABS y en plástico reciclado TPR. Diferentes modelos, distintos tamaños de hoja.
- (EN) Plasterboard saws made of magnesium steel. Ergonomic two-tone handle in ABS and recycled TPR plastic. Various models, different blade sizes.
- (DE) Gipskartonsägen aus Magnesiumstahl. Ergonomischer zweifarbigiger Griff aus ABS und recyceltem TPR-Kunststoff. Verschiedene Modelle, unterschiedliche Klingenslängen.

## ESPÁTULA PINTOR INOX



REF.	Medidas			
40825	25 mm	Granel	1	8421411024355
40840	40 mm	Blister	1	8421411023310
40860	60 mm	Granel	1	8421411023327
40880	80 mm	Granel	1	8421411023334
408100	100 mm	Granel	1	8421411023341
408120	120 mm	Granel	1	8421411024362

- (ES) Espátulas de pintor de acero inoxidable con mango antideslizante. Disponibles en anchos de 25, 40, 60, 80, 100 y 120 mm.
- (EN) Stainless steel painter's spatulas with non-slip handle. Available in widths of 25, 40, 60, 80, 100, and 120 mm.
- (DE) Maler-Spachtel aus Edelstahl mit rutschfestem Griff. Erhältlich in den Breiten 25, 40, 60, 80, 100 und 120 mm.

## JUEGO DE ESPÁTULAS



REF.	Tamaños			
40804	50 mm ; 80 mm ; 100 mm ; 120 mm	Blister	1	8421411024959

- (ES) Juego de espátulas en acero inoxidable, (tipo carrocer) Incluye 4 piezas (tamaños: 50 mm, 80 mm, 100 mm y 120 mm).
- (EN) Set of spatulas made of stainless steel. Includes 4 pieces (sizes: 50 mm, 80 mm, 100 mm, and 120 mm).
- (DE) Satz Spachteln aus Edelstahl. Enthält 4 Stück (Größen: 50 mm, 80 mm, 100 mm und 120 mm).

# TIJERAS

SCISSORS

SCHEREN



TIJERAS PARA ELECTRICISTA INOX	REF.	Medida	Material			
	<b>4591</b>	145 mm	Inox	Blister	10	8421411016114

(ES) Tijeras ideal electricistas. Hojas de acero inoxidable. Disponible en 145 mm.

(EN) Scissors ideal for electricians. Stainless steel blades. Available in 145 mm.

(DE) Schere ideal für Elektriker. Edelstahlklingen. Erhältlich in 145 mm.

TIJERAS MULTIUSO INOX	REF.	Medida	Material			
	<b>4583</b>	200 mm	Inox	Blister	10	8421411016169
	<b>4584</b>	245 mm	Inox	Blister	20	8421411016152

(ES) Tijeras multiuso y ergonómicas, para uso cotidiano. Hojas de acero inoxidable. Disponibles en 200 y 245 mm.

(EN) Multi-purpose and ergonomic scissors for everyday use. Stainless steel blades. Available in 200 and 245 mm.

(DE) Multifunktionale und ergonomische Scheren für den täglichen Gebrauch. Klingen aus Edelstahl. Erhältlich in 200 und 245 mm.

TIJERAS MULTIUSO INOX BIMATERIAL	REF.	Medida	Material			
	<b>4581</b>	180 mm	Inox	Blister	10	8421411016183
	<b>4582</b>	200 mm	Inox	Blister	10	8421411016176

(ES) Tijeras multiuso. Hojas de acero inoxidable. Disponibles en 180 y 200 mm.

(EN) Multi-purpose scissors. Stainless steel blades. Available in 180 and 200 mm.

(DE) Multifunktionale Scheren. Klingen aus Edelstahl. Erhältlich in 180 und 200 mm.

TIJERAS CORTACHAPAS	REF.	Medidas	Material			
	<b>72250</b>	250 mm (recto)	CR-V	Blister	1	8421411023198
	<b>72251</b>	250 mm (derecha)	CR-V	Blister	1	8421411023204
	<b>72252</b>	250 mm (izquierda)	CR-V	Blister	1	8421411023211

(ES) Tijeras corta chapas articulada 250 mm, con pestillo de cierre. Bocas forjadas en Cromo vanadio de alta resistencia. Cortan chapa y rejilla de metal hasta 1,2 mm Mango bimaterial ergonómico antideslizante. 3 tipos de corte: recto (Ref. 72250), derecha (Ref. 72251) y izquierda (Ref. 72252).

(EN) Articulated sheet metal scissors. Made of CR-V with bimaterial, ergonomic, and non-slip handle. Several options available in 250 mm: straight cut (Ref. 72250), right cut (Ref. 72251), and left cut (Ref. 72252).

(DE) Blechscheren mit Gelenk, 250 mm, mit Verriegelung. Backen aus hochfestem Chrom-Vanadium geschmiedet. Schneiden Bleche und Metallgitter bis zu 1,2 mm Dicke. Ergonomischer rutschfester 2K-Griff. 3 Schnittarten: gerade (Art.-Nr. 72250), rechts (Art.-Nr. 72251) und links (Art.-Nr. 72252).

# DISCOS DE CORTE

CUTTING DISCS

TRENNSCHEIBEN



## DISCOS DE CORTE ACERO



REF.	Ø mm	Espesor			
CA11530	115	3 mm	Blister	10	8421411017913
CA12530	125	3 mm	Blister	10	8421411017920
CA18030	180	3 mm	Blister	10	8421411017937
CA23030	230	3 mm	Blister	10	8421411017944

- (ES) Discos para corte de acero. Espesor de 3 mm. Disponibles en diámetros de 115, 125, 180 y 230 mm.
- (EN) Steel cutting discs. 3 mm thickness. Available in diameters of 115, 125, 180, and 230 mm.
- (DE) Trennscheiben für Stahl. 3 mm Dicke. Erhältlich in Durchmessern von 115, 125, 180 und 230 mm.

## DISCOS DE CORTE PARA AMOLADORA



REF.	Ø mm	Espesor			
CI11510	115	1 mm	Blister	10	8421411017951
CI12510	125	1 mm	Blister	10	8421411017968
CI18016	180	1,6 mm	Blister	10	8421411017975
CI23018	230	1,8 mm	Blister	10	8421411017982

- (ES) Discos para corte de acero inoxidable y acero. Espesor de 1, 1,6 y 1,8 mm. Disponibles en diámetros de 115, 125, 180 y 230 mm.
- (EN) Discs for cutting stainless steel and steel. Thickness of 1, 1.6, and 1.8 mm. Available in diameters of 115, 125, 180, and 230 mm.
- (DE) Trennscheiben für Edelstahl und Stahl. Dicken von 1, 1,6 und 1,8 mm. Erhältlich in Durchmessern von 115, 125, 180 und 230 mm.

## DISCOS DESBASTE ACERO



REF.	Ø mm	Espesor			
DA11560	115	6 mm	Blister	10	8421411018071
DA12560	125	6 mm	Blister	10	8421411018088
DA18070	180	7 mm	Blister	10	8421411018095
DA23080	230	8 mm	Blister	10	8421411018101

- (ES) Discos para desbastar acero. Espesor de 6, 7 y 8 mm. Disponibles en diámetros de 115, 125, 180 y 230 mm.
- (EN) Discs for grinding steel. Thickness of 6, 7, and 8 mm. Available in diameters of 115, 125, 180, and 230 mm.
- (DE) Schruppscheiben für Stahl. Dicken von 6, 7 und 8 mm. Erhältlich in Durchmessern von 115, 125, 180 und 230 mm.

## DISCOS DE LÁMINAS DESBASTE ACERO



REF.	Ø mm	Grano			
LA115AN40	115	40	Blister	10	8421411018118
LA115AN60	115	60	Blister	10	8421411018125
LA115AN80	115	80	Blister	10	8421411018132

- (ES) Discos de láminas para desbaste de acero inoxidable y acero. Disponibles en diámetro de 115 mm.
- (EN) Flap discs for grinding stainless steel and steel. Available in a diameter of 115 mm.
- (DE) Fächerschleifscheiben für Stahl und Holz. Erhältlich im Durchmesser 115 mm.



# DISCOS DE CORTE

CUTTING DISCS

TRENNSCHEIBEN



DISCOS DE LÁMINAS DESBASTE ACERO INOXIDABLE	REF.	Ø mm	Grano			
	LI115ZN40	115	40	Blister	10	8421411018149
	LI115ZN60	115	60	Blister	10	8421411018156
	LI115ZN80	115	80	Blister	10	8421411018163

(ES) Discos de láminas para desbaste de acero inoxidable y acero. Disponibles en diámetro de 115 mm.  
 (EN) Flap discs for grinding stainless steel and steel. Available in a diameter of 115 mm.  
 (DE) Fächerschleifscheiben für Edelstahl und Holz. Erhältlich im Durchmesser 115 mm.

DISCOS DE DIAMANTE SEGMENTADOS GENERAL OBRAS	REF.	Ø mm			
	SG115	115	Blister	1	8421411007280
	SG230	230	Blister	1	8421411007303

(ES) Discos diamantados profesionales para obra. No apto para corte de metales. Disponibles en diámetros de 115 y 230 mm.  
 (EN) Professional diamond discs for construction. Not suitable for cutting metals. Available in diameters of 115 and 230 mm.  
 (DE) Professionelle Diamanttrennscheiben für den Bau. Nicht geeignet zum Schneiden von Metallen. Erhältlich in den Durchmessern 115 und 230 mm.

DISCOS DE DIAMANTE TURBO GENERAL OBRAS	REF.	Ø mm			
	TG115	115	Blister	1	8421411007389
	TG230	230	Blister	1	8421411007426

(ES) Discos diamantados profesionales para obra de corte rápido. No apto para corte de metales. Disponibles en diámetros de 115 y 230 mm.  
 (EN) Professional diamond discs for fast cutting in construction. Not suitable for cutting metals. Available in diameters of 115 and 230 mm.  
 (DE) Professionelle Diamanttrennscheiben für den Bau. Nicht geeignet zum Schneiden von Metallen. Erhältlich in den Durchmessern 115 und 230 mm.

DISCOS DE DIAMANTE SEGMENTADOS PROFESIONALES	REF.	Ø mm			
	SP115	115 mm	Blister	1	8421411007334
	SP125	125 mm	Blister	1	8421411007341
	SP230	230 mm	Blister	1	8421411007358

(ES) Discos diamantados profesionales para corte de granito. Disponibles en diámetros de 115, 125 y 230 mm.  
 (EN) Professional diamond discs for cutting granite. Available in diameters of 115, 125, and 230 mm.  
 (DE) Professionelle Diamanttrennscheiben für Granit. Erhältlich in den Durchmessern 115, 125 und 230 mm.

DISCOS DE DIAMANTE TURBO PROFESIONALES	REF.	Ø mm			
	TP115	115 mm	Blister	1	8421411007457
	TP125	125 mm	Blister	1	8421411012765
	TP230	230 mm	Blister	1	8421411007495

(ES) Discos diamantados profesionales para corte de granito. Corte rápido. Disponibles en diámetros de 115, 125 y 230 mm.  
 (EN) Professional diamond discs for fast cutting of granite. Available in diameters of 115, 125, and 230 mm.  
 (DE) Professionelle Diamanttrennscheiben für Granit. Schnelles Schneiden. Erhältlich in den Durchmessern 115, 125 und 230 mm.

# DISCOS DE CORTE

CUTTING DISCS

TRENNSCHEIBEN

## DISCOS BANDA CONTINUA CERÁMICA



REF.	Ø mm			
<b>BC115</b>	115 mm	Blister	1	8421411007532
<b>BC230</b>	230 mm	Blister	1	8421411007587

- (ES)** Discos diamantados profesionales, para corte de cerámica y azulejos. Disponibles en diámetros de 115 y 230 mm.
- (EN)** Professional diamond discs for cutting ceramic and tiles. Available in diameters of 115 and 230 mm.
- (DE)** Professionelle Diamanttrennscheiben mit geschlossenem Schneidrand zum Schneiden von Keramik und Fliesen. Erhältlich in den Durchmessern 115 und 230 mm.

## DISCOS DE DIAMANTE PARA CORTE DE CERÁMICA Y PORCELANATO



REF.	Ø mm			
<b>CDC115</b>	115 mm	Blister	1	8421411016565
<b>CDC125</b>	125 mm	Blister	1	8421411021736
<b>CDC230</b>	230 mm	Blister	1	8421411021743

- (ES)** Discos diamantados profesionales para corte de porcelanato. Disponibles en diámetros de 115, 125 y 230 mm.
- (EN)** Professional diamond discs for cutting porcelain tiles. Available in diameters of 115, 125, and 230 mm.
- (DE)** Professionelle Diamanttrennscheiben für Feinsteinzeug. Erhältlich in den Durchmessern 115, 125 und 230 mm.

## DISCO DE DIAMANTE PARA CORTE MADERA



MADERA  
WOOD  
HOLZ

REF.	Ø mm			
<b>CDM115</b>	115 mm	Blister	1	8421411016572
<b>CDM125</b>	125 mm	Blister	1	8421411021187
<b>CDM230</b>	230 mm	Blister	1	8421411016589

- (ES)** Discos de tungsteno para corte de madera. Disponibles en diámetros de 115, 125 y 230 mm.
- (EN)** Tungsten discs for cutting wood, and other non-metallic construction materials. Available in diameters of 115, 125 and 230 mm.
- (DE)** Wolfram-Trennscheiben für Holz und andere nicht-metallische Baumaterialien. Erhältlich in den Durchmessern 115, 125 und 230 mm.

## DISCO EXTRAFINO DE DIAMANTE PREMIUM



REF.	Ø mm			
<b>XX115</b>	115 mm	Blister	1	8421411023396

- (ES)** Disco extra finos de diamante (espesor 1,2 mm) para azulejos, baldosas, piedra natural, porcelana o gres. Segmentado en doble XX. Disponible en diámetros de 115 mm.
- (EN)** Extra thin diamond disc (1.2 mm thickness) for tiles, ceramic tiles, natural stone, porcelain, or stoneware. Segmented with double XX. Available in a diameter of 115 mm.
- (DE)** Extra dünne Diamanttrennscheibe (1,2 mm Dicke) für Fliesen, Keramikfliesen, Naturstein, Porzellan oder Steinzeug. Mit Doppel-X-Segment. Erhältlich im Durchmesser 115 mm.

## DISCO EXTRAFINO DE DIAMANTE SLIM-FAST



REF.	Ø mm			
<b>81115</b>	115 mm	Blister	1	8421411024287

- (ES)** Disco extra finos de diamante (espesor 1,2 mm) para piedra natural y artificial, mármol, baldosas, hormigón y pladur. Ancho del segmento 10 mm. Disponible en diámetros de 115 mm.
- (EN)** Extra-thin diamond disc (1.2 mm thickness) for natural and artificial stone, marble, tiles, concrete, and plasterboard. Segment width 10 mm. Available in diameters of 115 mm.
- (DE)** Extra dünne Diamanttrennscheibe (1,2 mm Dicke) für Natur- und Kunststein, Marmor, Fliesen, Beton und Gipskarton. Segmentbreite 10 mm. Erhältlich im Durchmesser 115 mm.

BROCAS CORONA DIAMANTADAS		REF.	Ø mm			
	80106	80106	6	Blíster	1	8421411023440
	80160	80108	8	Blíster	1	8421411023457
	80140	80110	10	Blíster	1	8421411023464
		80112	12	Blíster	1	8421411023471
		80116	16	Blíster	1	8421411023488
		80120	20	Blíster	1	8421411023495
		80127	27	Blíster	1	8421411023501
		80135	35	Blíster	1	8421411023518
		80140	40	Blíster	1	8421411023525
		80150	50	Blíster	1	8421411023532
		80160	60	Blíster	1	8421411023549
		80168	68	Blíster	1	8421411024010
		80175	75	Blíster	1	8421411023556
		80186	86	Blíster	1	8421411023563
		80195	95	Blíster	1	8421411023570



Uso en seco  
Dry cutting  
Trockenschnitt

- (ES) Brocas corona diamantadas soldadas al vacío. M14. Para mármol, baldosas de porcelana y granito. Disponibles en distintos diámetros.
- (EN) Vacuum-brazed diamond core bits. M14. For marble, porcelain tiles, and granite. Available in various diameters.
- (DE) Vakuumgelötete Diamantbohrkronen. M14. Für Marmor, Porzellanfliesen und Granit. Erhältlich in verschiedenen Durchmessern. Bohrtiefe: 40 mm.

BROCAS CORONA DIAMANTADAS		REF.	Ø mm			
	80206	80206	6	Blíster	1	8421411023587
	80208	80208	8	Blíster	1	8421411023594
	80210	80210	10	Blíster	1	8421411023600
	80212	80212	12	Blíster	1	8421411023617



Uso en seco  
Dry cutting  
Trockenschnitt

- (ES) Brocas corona diamantadas soldadas al vacío. M14. Con cera. Para baldosas, porcelana, granito de poco espesor, piedra natural. Disponibles en diámetros de 6, 8, 10 y 12 mm.
- (EN) Vacuum-brazed diamond core bits. M14. With wax. For thin tiles, porcelain, granite, and natural stone. Available in diameters of 6, 8, 10, and 12 mm.
- (DE) Vakuumgelötete Diamantbohrkronen. M14. Mit Wachs. Für Marmor, Porzellanfliesen und Granit geringer Dicke. Erhältlich in den Durchmessern 6, 8, 10 und 12 mm.

BROCAS CORONA DIAMANTADAS		REF.	Ø mm			
	80306	80306	6 mm	Blíster	1	8421411023624
	80308	80308	8 mm	Blíster	1	8421411023631
	80310	80310	10 mm	Blíster	1	8421411023648
	80312	80312	12 mm	Blíster	1	8421411023655
	803014	803014	14 mm	Blíster	1	8421411023662



Uso en seco  
Dry cutting  
Trockenschnitt

- (ES) Brocas diamante. Soldada al vacío. Hex. Con cera. Para baldosas, porcelana, granito de poco espesor, piedra natural. Disponibles en diámetros de 6, 8, 10, 12 y 14 mm.
- (EN) Diamond drill bits. Vacuum-brazed. Hex shank. With wax. For thin tiles, porcelain, granite, and natural stone. Available in diameters of 6, 8, 10, 12, and 14 mm.
- (DE) Vakuumgelötete Bohrkronen mit Sechskantschaft. Mit Wachs. Für dünne Fliesen, Porzellan, Granit und Naturstein. Erhältlich in den Durchmessern 6, 8, 10, 12 und 14 mm.



## GUÍA PARA CENTRADO DE BROCAS



REF.	Ø mm			
805412	4, 5, 6, 7, 8, 10, 12	Blíster	1	8421411023723

- (ES) Guía para centrado de brocas. Disponible para diámetros de 4, 5, 6, 7, 8, 10, 12 mm.
- (EN) Centering guide for drill bits. Available for diameters of 4, 5, 6, 7, 8, 10, and 12 mm.
- (DE) Zentrierhilfe für Bohrer. Erhältlich für die Durchmesser 4, 5, 6, 7, 8, 10 und 12 mm.

## ADAPTADOR PARA PASAR DE M14 A HEXAGONAL



REF.	Ø mm			
805413	M14 / HEX 58	Blíster	1	8421411024003

- (ES) Adaptador para pasar de M14 a Hexagonal.
- (EN) Adapter to convert from M14 to hexagonal.
- (DE) Adapter, für M14 auf Sechskantschaft.

## JUEGO DE 19 BROCAS HSS PARA METAL



REF.	Descripción			
8019	19 uds. para metal	Caja	1	8421411018231

- (ES) Juego de 19 brocas para metal. HSS (High Speed Steel). Diámetros: 1,0 - 10,0 x 0,5 mm.
- (EN) Set of 19 metal drill bits. HSS (High Speed Steel). Diameters: 1.0 - 10.0 x 0.5 mm.
- (DE) Satz von 19 Metallbohrern. HSS (High Speed Steel). Durchmesser: 1,0 - 10,0 x 0,5 mm.

## JUEGO DE BROCAS PARA METAL

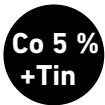

REF.	Descripción			
9019	19 uds. para metal	Caja	1	8421411020937
9025	25 uds. para metal	Caja	1	8421411020944

- (ES) Juego de 19 y 25 brocas para metal. HSS (High Speed Steel). Recubierto de titanio. Diámetros: 1,0 - 10,0 x 0,5 mm.
- (EN) Set of 19 and 25 metal drill bits. HSS (High Speed Steel). Titanium-coated. Diameters: 1.0 - 10.0 x 0.5 mm.
- (DE) Satz von 19 und 25 Metallbohrern. HSS (High Speed Steel). Titanbeschichtet. Durchmesser: 1,0 - 10,0 x 0,5 mm.

## JUEGO DE 8 BROCAS PARA MADERA



REF.	Descripción			
9028	8 uds. para madera	Caja	1	8421411020951

- (ES) Juego de 8 brocas para madera. Diámetros: 3, 4, 5, 6, 7, 8, 9 y 10 mm.
- (EN) Set of 8 wood drill bits. Diameters: 3, 4, 5, 6, 7, 8, 9, and 10 mm.
- (DE) Satz von 8 Holzbohrern. Durchmesser: 3, 4, 5, 6, 7, 8, 9 und 10 mm.

# HILO DE NYLON

NYLON THREAD

NYLONFADEN



CORONA DIAMANTE	REF.	Ø mm			
	80404	4 mm	Blister	1	8421411023679
	80406	6 mm	Blister	1	8421411023686
	80408	8 mm	Blister	1	8421411023693
	80410	10 mm	Blister	1	8421411023709
	80412	12 mm	Blister	1	8421411023716

Corte húmedo  
Wet cutting  
Nassbohren

**(ES)** Brocas corona diamante. Hex. Electrodepositado. Para cristal, vidrio, fibra de vidrio, azulejos, cerámica, porcelana, y otros materiales compuestos. Disponibles en diámetros de 4, 6, 8, 10 y 12 mm. Profundidad de Perforación: 30 mm.

**(EN)** Diamond core drill bits. Hex shank. Electroplated. For glass, glass, fiberglass, tiles, ceramics, porcelain, marble, granite, stone, and other composite materials. Available in diameters of 4, 6, 8, 10, and 12 mm. Drilling depth: 30 mm.

**(DE)** Diamantbohrkronen mit Sechskantschaft. Galvanisch beschichtet. Für Glas, Spiegel, Glasfaser, Fliesen, Keramik, Porzellan und andere Verbundwerkstoffe. Erhältlich in den Durchmessern 4, 6, 8, 10 und 12 mm. Bohrtiefe: 30 mm.

HILO DE NYLON REDONDO AMARILLO	REF.	m	Ø mm	Perfil			
	342415	15 m	2,4 mm	Redondo		Colgador	1 8421411025086
	343015	15 m	3,0 mm	Redondo		Colgador	1 8421411025093
	343315	15 m	3,3 mm	Redondo		Colgador	1 8421411025109

NUEVO

**(ES)** Hilos de nylon para desbrozadoras y cortabordes de 15 m. Perfil de hilo redondo, de color amarillo y con distintas medidas de ancho.

**(EN)** Nylon threads for brush cutters and edge trimmers, 15 m in length. Round profile thread, yellow in color, with various width options.

**(DE)** Nylonfäden für Rasentrimmer und -kantenschneider, 15 m Länge. Gelber Rundfaden, in verschiedenen Breiten.

HILO DE NYLON CUADRADO ROJO	REF.	m	Ø mm	Perfil			
	342416	15 m	2,4 mm	Cuadrado		Colgador	1 8421411025116
	343016	15 m	3,0 mm	Cuadrado		Colgador	1 8421411025123
	343316	15 m	3,3 mm	Cuadrado		Colgador	1 8421411025130

NUEVO

**(ES)** Hilos de nylon para desbrozadoras y cortabordes de 15 m. Perfil de hilo cuadrado, de color rojo y con distintas medidas de ancho.

**(EN)** Nylon threads for brush cutters and edge trimmers, 15 m in length. Square profile thread, red in color, with various width options.

**(DE)** Nylonfäden für Rasentrimmer und -kantenschneider, 15 m Länge. Roter Vierkantfaden, in verschiedenen Breiten.

HILO DE NYLON REDONDO AMARILLO DOBLE BLISTER	REF.	m	Ø mm	Perfil			
	342486	86 m	2,4 mm	Redondo		2 Blister	1 8421411025147
	343556	56 m	3,0 mm	Redondo		2 Blister	1 8421411025154
	343337	37 m	3,3 mm	Redondo		2 Blister	1 8421411025161

NUEVO

**(ES)** Hilos de nylon para desbrozadoras y cortabordes de 37, 56 y 86 m. Perfil de hilo redondo, de color amarillo y con distintas medidas de ancho.

**(EN)** Nylon threads for brush cutters and edge trimmers, in lengths of 37, 56, and 86 meters. Round profile thread, yellow in color, with various width options.

**(DE)** Nylonfäden für Rasentrimmer und -kantenschneider, 37, 56 und 86 m Länge. Gelber Rundfaden, in verschiedenen Breiten.



# HILO DE NYLON

NYLON THREAD

NYLONFADEN



## HILO DE NYLON CUADRADO ROJO DOBLE BLÍSTER



**NUEVO**

REF.	m	Ø mm	Perfil				
342471	71 m	2,4 mm	Cuadrado	●	2 Blister	1	8421411025178
343045	45 m	3,0 mm	Cuadrado	●	2 Blister	1	8421411025185
343332	32 m	3,3 mm	Cuadrado	●	2 Blister	1	8421411025192

- (ES) Hilos de nylon para desbrozadoras y cortabordes de 32, 45 y 71 m. Perfil de hilo cuadrado, de color rojo y con distintas medidas de ancho.
- (EN) Nylon threads for brush cutters and edge trimmers, in lengths of 32, 45, and 71 meters. Square profile thread, red in color, with various width options.
- (DE) Nylonfäden für Rasentrimmer und -kantenschneider, 32, 45 und 71 m Länge. Roter Vierkantfaden, in verschiedenen Breiten.

## HILO DE NYLON REDONDO AMARILLO BOBINA



**NUEVO**

REF.	m	Ø mm	Perfil				
3430125	125 m	3,0 mm	Redondo	●	Bobina	1	8421411025208
3433100	106 m	3,3 mm	Redondo	●	Bobina	1	8421411025215

- (ES) Hilos de nylon para desbrozadoras y cortabordes de 106 y 125 m. Perfil de hilo redondo, de color amarillo y con distintas medidas de ancho.
- (EN) Nylon threads for brush cutters and edge trimmers, in lengths of 106 and 125 meters. Round profile thread, yellow in color, with various width options.
- (DE) Nylonfäden für Rasentrimmer und -kantenschneider, 106 und 125 m Länge. Gelber Rundfaden, in verschiedenen Breiten.

## HILO DE NYLON CUADRADO ROJO BOBINA



**NUEVO**

REF.	m	Ø mm	Perfil				
3430100	100 m	3,0 mm	Cuadrado	●	Bobina	1	8421411025222
3433383	83 m	3,3 mm	Cuadrado	●	Bobina	1	8421411025239

- (ES) Hilos de nylon para desbrozadoras y cortabordes de 83 y 100 m. Perfil de hilo cuadrado, de color rojo y con distintas medidas de ancho.
- (EN) Nylon threads for brush cutters and edge trimmers, in lengths of 83 and 100 meters. Square profile thread, red in color, with various width options.
- (DE) Nylonfäden für Rasentrimmer und -kantenschneider, 83 und 100 m Länge. Roter Vierkantfaden, in verschiedenen Breiten.

## HILO DE NYLON REDONDO AMARILLO PARA CONSTRUCCIÓN



**NUEVO**

REF.	m	Ø mm	Perfil				
3413100	100 m	1,3 mm	Redondo	●	Bobina	1	8421411025246

- (ES) Hilo de nylon para desbrozadoras y cortabordes de 100 m. Perfil de hilo redondo, de color fluor y con una medida de 1.3 mm de ancho.
- (EN) Nylon thread for brush cutters and edge trimmers, 100 meters in length. Round profile thread, fluorescent color, with a width of 1.3 mm.
- (DE) Nylonfaden für die Bauindustrie, 100 m Länge. Runder Faden, fluoreszierende Farbe, mit einem Durchmesser von 1,3 mm.



# HERRAMIENTAS MANUALES

HAND TOOLS

HANDWERKZEUGE

## JUEGO DE 9 LLAVES LARGAS HEXAGONALES

REF.

Medidas llaves



6009

1,5, 2, 2,5, 3, 4, 5, 6, 8 y 10 mm

Blister

1

8421411020777



- ES Set de 9 llaves hexagonales largas.
- EN 9 pcs hex long key set.
- DE Satz mit 9 langen Inbusschlüsseln.

## JUEGO DE 9 LLAVES LARGAS PUNTA BOLA

REF.

Medidas llaves



6019

1,5, 2, 2,5, 3, 4, 5, 6, 8 y 10 mm

Blister

1

8421411020784



- ES Set de 9 llaves hexagonales largas con punta de bola.
- EN 9 pcs ball point hex long key set.
- DE Satz mit 9 langen Inbusschlüsseln mit Kugelkopf.

## JUEGO DE 9 LLAVES LARGAS TORX

REF.

Medidas llaves



6029

T10, T15, T20, T25, T27, T30, T40, T45 y T50

Blister

1

8421411020791



- ES Set de 9 llaves largas Torx inviolables.
- EN 9 pcs Torx with hole long key set.
- DE Satz mit 9 langen Torx-Schlüsseln mit Loch.

## JUEGO DE 8 LLAVES HEXAGONALES

REF.

Medidas llaves



6008

1,5, 2, 2,5, 3, 4, 5, 6 y 8 mm

Caja

1

8421411020746



- ES Set de 8 llaves hexagonales.
- EN 8 pcs hex key set.
- DE Satz mit 8 Inbusschlüsseln.

## JUEGO DE 8 LLAVES HEXAGONALES PUNTA BOLA

REF.

Medidas llaves



6018

1,5, 2, 2,5, 3, 4, 5, 6 y 8 mm

Caja

1

8421411020753



- ES Set de 8 llaves hexagonales con punta de bola.
- EN 8 pcs ball point hex key set.
- DE Satz mit 8 Inbusschlüsseln mit Kugelkopf.



# HERRAMIENTAS MANUALES

HAND TOOLS

HANDWERKZEUGE



JUEGO DE 8 LLAVES TORX	REF.	Medidas llaves			
	<b>6028</b>	T9, T10, T15, T20, T25, T27, T30 y T40	Caja	1	8421411020760
	<p><b>Cr-V</b></p> <ul style="list-style-type: none"> <li>(ES) Set de 8 llaves Torx inviolables.</li> <li>(EN) 8 pcs Torx with hole key set.</li> <li>(DE) Satz mit 8 manipulationssicheren Torx-Schlüsseln.</li> </ul>				

JUEGO DE 12 LLAVES COMBINADAS	REF.	Medidas llaves				
	<b>8011</b>	6, 7, 8, 9, 10, 11, 12, 13, 14, 17, 19 y 22 mm	Satinado	Granel	1	8421411023273
	<b>8012</b>	6, 7, 8, 9, 10, 11, 12, 13, 14, 17, 19 y 22 mm	Cromado	Blister	1	8421411020630
<p><b>Cr-V</b></p> <ul style="list-style-type: none"> <li>(ES) Sets de 12 llaves combinadas. Satinado o cromado.</li> <li>(EN) Set of 12 combined spanner. Satin or chrome-plated.</li> <li>(DE) Satz mit 12 Maul-/Ringschlüsseln.</li> </ul>						

JUEGO DE 8 LLAVES FIJAS	REF.	Medidas llaves				
	<b>8005</b>	6-7, 8-9, 10-11, 12-13, 14-15, 16-17, 18-19 y 20-22	Satinado	Granel	1	8421411023259
	<b>8006</b>	6-7, 8-9, 10-11, 12-13, 14-15, 16-17, 18-19 y 20-22	Cromado	Blister	1	8421411020647
<p><b>Cr-V</b></p> <ul style="list-style-type: none"> <li>(ES) Sets de 8 llaves fijas. Satinado o cromado.</li> <li>(EN) Set of 8 open end spanner. Satin or chrome-plated.</li> <li>(DE) Satz mit 8 Maulschlüsseln. Matt oder verchromt.</li> </ul>						

JUEGO DE 8 LLAVES ACODADAS	REF.	Medidas llaves				
	<b>8008</b>	6-7,8-9,10-11,12-13,14-15,16-17,18-19,20-22	Cromado	Granel	1	8421411020623
	<b>8009</b>	6-7,8-9,10-11,12-13,14-15,16-17,18-19,20-22	Satinado	Blister	1	8421411023266
<p><b>Cr-V</b></p> <ul style="list-style-type: none"> <li>(ES) Sets de 8 llaves acodadas fijas. Satinado o cromado.</li> <li>(EN) Set of 8 ring spanner. Satin or chrome-plated.</li> <li>(DE) Satz mit 8 gekrümmten Maulschlüsseln. Matt oder verchromt.</li> </ul>						

# HERRAMIENTAS MANUALES

HAND TOOLS

HANDWERKZEUGE

## LLAVES DE TUBO

REF.

Medidas llaves



8028

6-7, 8-9, 10-11, 12-13, 14-15, 16-17, 18-19 y 20-22

Funda

1

8421411022870



- (ES) Set de 8 llaves de tubo hexagonales. Se entrega con funda de nylon con bolsillo para cada llave.
- (EN) 8 pieces set of Box spanners. Comes with a nylon bag with a pocket for each wrench.
- (DE) Satz mit 8 Steckschlüsseln. Wird mit einer Nylonhülle geliefert, mit individueller Tasche für jeden Schlüssel.

## LLAVES DE CARRACA REVERSIBLE

REF.

Medidas

Tipo



8313

1/2"

Cromado

Granel

1

8421411023228

8365

3/8"

Cromado

Granel

1

8421411023242

8395

1/4"

Cromado

Granel

1

8421411023235



- (ES) Llaves de carraca reversibles con mango ergonómico bimaterial antideslizante. Cómodo cambio de dirección en el cabezal de la llave. Mecanismo a 72 dientes. Cabezal y carraca en acero SCM440. Mango en acero 40CR. Acabado cromado.
- (EN) Reversible ratchet keys with ergonomic dual-material non-slip handle. Convenient direction change on the key head. 72-tooth mechanism. Head and ratchet made of SCM440 steel. Handle made of 40CR steel. Chromed finish.
- (DE) Ratschenschlüssel-Set mit umschaltbarem ergonomischem, rutschfestem 2K-Griff. Bequemes Umschalten am Schlüsselkopf. Mechanismus mit 72 Zähnen. Kopf und Ratsche aus SCM440-Stahl. Griff aus 40CR-Stahl. Verchromt.

## LLAVES AJUSTABLES

REF.

Medidas llaves



74150

150 mm

Granel

1

8421411022627

74200

200 mm

Granel

1

8421411022634

74250

250 mm

Granel

1

8421411022641



- (ES) Llaves ajustables de cromo y vanadio satinado. Husillo central con mordaza. Milimetrada. Disponible en distintas medidas.
- (EN) Satin chrome and vanadium adjustable wrenches. Central spindle with jaws. Graduated in millimeters. Available in various sizes.
- (DE) Verchromte und vanadiumlegierte verstellbare Schraubenschlüssel. Zentrale Spindel mit Backen. Millimetergenau. Erhältlich in verschiedenen Größen.

## LLAVES AJUSTABLES BIMATERIAL

REF.

Medidas llaves



74201

200 mm

Granel

1

8421411023167

74251

250 mm

Granel

1

8421411023174

74301

300 mm

Granel

1

8421411023181



- (ES) Llaves ajustables pavonadas con mango ergonómico bimaterial antideslizante. Husillo central con mordaza. Milimetrada. Disponible en distintas medidas.
- (EN) Phosphated adjustable wrenches with ergonomic non-slip bimaterial handle. Central spindle with jaws. Graduated in millimeters. Available in various sizes.
- (DE) Verstellbare brünierte Schraubenschlüssel mit ergonomischem rutschfestem 2K-Griff. Zentrale Spindel mit Backen. Millimetergenau. Erhältlich in verschiedenen Größen.



# HERRAMIENTAS MANUALES

HAND TOOLS

HANDWERKZEUGE



SET DE 8 DESTORNILLADORES AISLADOS	REF.			
	WAPE402	Blister	1	8421411021828
<p>(ES) Set de 8 destornilladores aislados. Para trabajos bajo tensiones de hasta 1.000 V, con busca-polos (hasta 220 V).</p> <p>(EN) Set of 8 isolated screwdrivers. To work under voltages up to 1000 V, with tester up to 220 V.</p> <p>(DE) Satz mit 8 isolierten Schraubendrehern. Für Arbeiten unter Spannungen bis zu 1.000 Volt, mit Phasenprüfer (bis 220 V).</p> <p><b>➔ 5,5 x 125 mm, 6,5 x 150 mm. Tester (hasta 220 V)</b></p> <p><b>➕ PH0 x 60 mm, PH1 x 80 mm, PH2 x 100 mm</b></p> <p><b>✳ PZ1 x 100 mm, PZ2 x 100 mm</b></p>				

DESTORNILLADOR BUSCAPOLOS	REF.	Medidas			
	1122	3 x 65 mm	Blister	1	8421411021958
<p>(ES) Destornillador 3 x 65 mm buscapolos 3,0/110-220 V AC.</p> <p>(EN) Voltage tester screwdriver, 3,0/110-220 V AC.</p> <p>(DE) Schraubendreher 3 x 65 mm mit Phasenprüfer 3,0/110-220 V AC.</p>					

PORTAPUNTAS MAGNÉTICO	REF.	Medidas			
	6125	6,3 x 100 mm	Blister	1	8421411021941
<p>(ES) Portapuntas magnético de alta calidad. Con mango resistente bimaterial de color negro combinado con rojo.</p> <p>(EN) High-quality magnetic bit holder. With a sturdy bimaterial handle in black combined with red.</p> <p>(DE) Hochwertiger magnetischer Bithalter. Mit einem robusten 2K-Griff in Schwarz und Rot.</p>					

SET DE 8 DESTORNILLADORES CROMO VANADIO	REF.			
	WAP602	Blister	1	8421411021804
<p>(ES) Set de 8 destornilladores cromo-vanadio con carroceros de punta plana. Presentado en estuche ABS.</p> <p>(EN) Set of 8 chrome-vanadium screwdrivers withstuy . Presented in an ABS transport case.</p> <p>(DE) Satz mit 8 Chrom-Vanadium Vergaser-Schraubendrehern. Aufbewahrung und Transport in einer ABS-Box.</p> <p><b>➔ 5 x 25 mm, 3 x 100 mm, 6 x 125 mm</b></p> <p><b>➕ PH0 x 75 mm, PH1 x 75 mm, PH2 x 100 mm</b></p> <p><b>✳ PZ1 x 100 mm, PZ2 x 100 mm</b></p>				

# HERRAMIENTAS MANUALES

HAND TOOLS

HANDWERKZEUGE

## SET DE 7 DESTORNILLADORES CROMO VANADIO

REF.



WA702

Blister

1

8421411021859



- (ES) Set de 7 destornilladores cromo-vanadio. Incluye soporte para la pared.
- (EN) Set of 7 chrome-vanadium screwdrivers. Includes a wall mount.
- (DE) Satz mit 7 Chrom-Vanadium-Schraubendrehern, einschließlich Wandhalterung.

- ⊖ 4 x 100 mm, 5,5 x 125 mm, 6,5 x 100 mm
- + PH1 x 100 mm, PH2 x 100 mm
- \* PZ1 x 100 mm, PZ2 x 100 mm

## SET DE 7 DESTORNILLADORES DE PRECISIÓN

REF.



WA302

Blister

1

8421411021835



- (ES) Set de 7 destornilladores de precisión, ideales para trabajos de electrónica.
- (EN) Set of 7 precision screwdrivers, ideal for electronic work.
- (DE) Satz mit 7 Präzisions-Schraubendrehern, ideal für Elektronikarbeiten.

- ⊖ 2, 2-5, 3 (x 50 mm)
- + PH00, PH0 (x 50 mm)
- \* T6, T8 (x 50 mm)

## PORTAPUNTAS MAGNÉTICO

REF.



SD021

Blister

1

8421411023730



- (ES) Puntas de destornillador de precisión. Juego de 21 piezas. Con mango bimatérial. Ideales para trabajos de electrónica, informática, telefonía, etc. En estuche de plástico con colgador.
- (EN) Precision screwdriver bits, Set of 21 pieces. With bimaterial handle. Ideal for electronics, computer, telephony, etc. In plastic case with hanger.
- (DE) Präzisions-Schraubendreher-Bits. Set mit 21 Teilen. Mit 2K-Griff. Ideal für Elektronik, Informatik, Telekommunikation, etc. In Kunststoffbox mit Aufhänger.

## PORTA PUNTAS A CARRACA

REF.



SD051

Blister

1

8421411021866



- (ES) Porta punta a carraca, con 5 puntas que pueden guardarse en el mango.
- (EN) Ratcheting bit holder, with 5 bits that can be stored in the handle.
- (DE) Bit-Halter mit Ratsche, mit 5 Bits, die im Griff aufbewahrt werden können.

- ⊖ 5 mm, 6 mm
- + PH1, PH2, PH3

# HERRAMIENTAS MANUALES

HAND TOOLS

HANDWERKZEUGE



SET DE 45 PUNTAS	REF.			
	SD045	Blister	1	8421411023747
<p>(ES) Puntas de destornillador. Set de 45 piezas compuesto por 44 puntas de 6,3 x 25 mm y adaptador magnético de 60 mm. Presentado en estuche de plástico con colgador.</p> <p>(EN) Screwdriver bits. Set of 45 pieces consisting of 44 bits of 6.3 and a 60 mm magnetic adapter, in a plastic case with a hanger.</p> <p>(DE) Schraubendreher-Bits. Satz bestehend aus 45 Teilen, mit 44 Bits von 6,3 x 25 mm und einem magnetischen Adapter von 60 mm. Aufbewahrung und Transport in einer Kunststoffbox mit Aufhänger.</p>				

SET DE 35 PUNTAS Y VASOS	REF.			
	SD-038	Blister	1	8421411021910
<p>(ES) Set de 35 puntas y llaves de vaso con mango articulado a carraca. Presentado en estuche de plástico con colgador.</p> <p>(EN) Set of 35 bits and socket keys with mini ratchet handle. Presented in a plastic case with hanger.</p> <p>(DE) Satz mit 35 Bits und Stecknüssen mit einem Ratschen-Gelenkgriff. Aufbewahrung und Transport in einer Kunststoffbox mit Aufhänger.</p>				
<p><b>PUNTAS BITS BITS (Cr-V)</b></p> <ul style="list-style-type: none"> <li>⊖ 2, 4, 5, 6</li> <li>⊕ PH0, PH1, PH2, PH3</li> <li>✱ PZ0, PZ1, PZ2, PZ3</li> <li>✱ T10, T15, T20, T25, T30</li> <li>○ H2, H3, H4, H5</li> <li>◻ S0, S1, S2</li> </ul>		<p><b>LLAVES SOCKETS STECKSCHLÜSSE (Carbon steel)</b></p> <ul style="list-style-type: none"> <li>⬢ 4, 5, 6, 7, 8, 9, 10, 11, 12</li> </ul>		

JUEGO DE 29 PUNTAS CON ADAPTADOR MAGNÉTICO	REF.			
	SD029	Blister	1	8421411021873
<p>(ES) Set de 29 puntas de 6,3 x 25 mm. Incluye adaptador magnético de 60 mm.</p> <p>(EN) Set of 29 bits 6,3 x 25 mm. Includes 60 mm magnetic adapter.</p> <p>(DE) Set mit 29 Bits von 6,3 x 25 mm, einschließlich einem magnetischen Adapter von 60 mm.</p>				

# HERRAMIENTAS MANUALES

HAND TOOLS

HANDWERKZEUGE

## ALICATE UNIVERSAL

REF.

Medidas



73175

175 mm

Blister

1

8421411022580



- (ES) Alicate universal CR-V con mango bimaterial antideslizante.
- (EN) Universal CR-V pliers with non-slip bimaterial handle.
- (DE) Universelle CR-V Zange mit rutschfestem 2K-Griff.

## ALICATE CORTE LATERAL

REF.

Medidas



73150

150 mm

Blister

1

8421411022597



- (ES) Alicate de corte lateral con mango bimaterial antideslizante.
- (EN) Side cutting pliers with non-slip bimaterial handle.
- (DE) Seitenschneider mit rutschfestem 2K-Griff.

## ALICATE BOCA LARGA

REF.

Medidas



73185

150 mm

Blister

1

8421411022603



- (ES) Alicate de boca larga con mango bimaterial antideslizante.
- (EN) Long-nose pliers with non-slip bimaterial handle.
- (DE) Langbeckzange mit rutschfestem 2K-Griff.

## SET 5 MINI ALICATES

REF.

Medidas



73114

114 mm

Blister

1

8421411022610



- (ES) Set de 5 mini-alcates de acero satinado para electrónica con mango soft antideslizante.
- (EN) Set of 5 mini satin-finish steel pliers for electronics with non-slip bimaterial handle.
- (DE) Set mit 5 Mini-Zangen aus mattem Stahl mit rutschfestem Softgriff, für Elektronkarbeiten.

# HERRAMIENTAS MANUALES

HAND TOOLS

HANDWERKZEUGE



MORDAZA AJUSTABLE	REF.	Medidas			
-------------------	------	---------	--	--	--

76230	230 mm	Blister	1	8421411022672
-------	--------	---------	---	---------------



- (ES) Mordaza ajustable (tenaza pico de loro) de acero parquerizado con mango bimaterial ergonómico.
- (EN) Adjustable pliers (slip joint pliers) with parkerized steel and ergonomic non-slip bimaterial handle.
- (DE) Verstellbare Zange (Wasserpumpenzange) aus phosphatiertem Stahl mit ergonomischem rutschfestem 2K-Griff.

TENAZA GRIP	REF.	Medidas			
-------------	------	---------	--	--	--

76250	250 mm	Blister	1	8421411022689
-------	--------	---------	---	---------------



- (ES) Tenaza grip de de acero niquelado con reglaje por tornillo.
- (EN) Nickel-plated steel locking pliers with adjustment screw.
- (DE) Gripzange aus vernickeltem Stahl mit Einstellschraube.

TENAZA CARPINTERO	REF.	Medidas			
-------------------	------	---------	--	--	--

75175	175 mm	Blister	1	8421411022658
-------	--------	---------	---	---------------



- (ES) Tenaza de carpintero. Filos de doble temple.
- (EN) Carpenter's pliers with double-tempered edges.
- (DE) Kneifzange mit doppelt gehärteten Schneiden.

TENAZA RUSA	REF.	Medidas			
-------------	------	---------	--	--	--

75230	230 mm	Blister	1	8421411022665
-------	--------	---------	---	---------------



- (ES) Tenaza rusa. Filos de doble temple.
- (EN) Russian pliers. Double-tempered edges.
- (DE) Monierange mit doppelt gehärteten Schneiden.



# HERRAMIENTAS MANUALES

HAND TOOLS

HANDWERKZEUGE

## MARTILLO EBANISTA BIMATERIAL



REF.	Medidas			
61020	20 mm	Grael	1	8421411023280
61025	25 mm	Grael	1	8421411023303
61030	30 mm	Grael	1	8421411023297

- (ES) Martillos de ebanista con mango bimaterial ergonómico. Disponibles en distintos tamaños.
- (EN) Carpenter's hammers with ergonomic bimaterial handle. Available in various sizes.
- (DE) Schreinerhammer mit ergonomischem 2K-Griff. Erhältlich in verschiedenen Größen.

## PISTOLA SILICONA DE CREMALLERA BEST



REF.	Varillas			
6220	3	Grael	1	8421411024935

- (ES) Pistola para silicona o tacho químico hecha de acero al carbono y con mango de aluminio. Con 3 varillas y 9". Incluye empujador redondo giratorio. Relación de empuje aprox 18:1. Apta para recambios standards de silicona o selladores acrílicos.
- (EN) Caulking gun or chemical anchor gun made of carbon steel with an aluminum handle. Comes with 3 rods and is 9 inches long. Includes a rotating round push rod. Approximate thrust ratio of 18:1. Suitable for standard silicone or acrylic sealant replacements.
- (DE) Kartuschenpistole oder Injektionsmörtel-Pistole aus Kohlenstoffstahl mit Aluminiumgriff. Mit 3 Stangen und 9 Zoll Länge. Inklusive drehbarem runden Drücker. Ungefähres Druckverhältnis von 18:1. Geeignet für Standard-Silikon oder Acryldichtstoffe.

## PISTOLA SILICONA TIPO TOP



REF.	Varillas			
6221	1	Grael	1	8421411024942

- (ES) Pistola de cremallera para silicona hecha de acero al carbono y con mango de aluminio. Con 1 varilla. Incluye punzón desatascador y aplicador giratorio reforzado. Relación de empuje aprox 18:1. Apta para recambios standards de silicona o selladores acrílicos.
- (EN) Rack-and-pinion silicone gun made of carbon steel with an aluminum handle. Comes with 1 rod. Includes a clog-clearing punch and reinforced rotating applicator. Approximate thrust ratio of 18:1. Suitable for standard silicone or acrylic sealant replacements.
- (DE) Zahnstangen-Pistole für Silikon aus Kohlenstoffstahl mit Aluminiumgriff. Mit 1 Stange. Inklusive Reinigungsstempel und verstärktem drehbarem Drücker. Ungefähres Druckverhältnis von 18:1. Geeignet für Standard-Silikon oder Acryldichtstoffe.

## SARGENTOS



REF.	Medidas			
79150	150 mm	Grael	1	8421411022764
79300	300 mm	Grael	1	8421411022771
79450	450 mm	Grael	1	8421411022788

- (ES) Sargentos de apriete rápido con mango soft antideslizante. Uso fácil y rápido con una sola mano. 2 posiciones de apriete: interior y exterior.
- (EN) Quick-release clamps with non-slip soft handle. Easy and fast to use with one hand. 2 clamping positions: interior and exterior. Clamping segments of 150, 300, and 450 mm.
- (DE) Schnellspannzwing mit rutschfestem Softgriff. Einfache und schnelle Einhandbedienung. 2 Spannpositionen: innen und außen. Spannsegmente von 150, 300 und 450 mm.

## MINI SARGENTOS



REF.	Medidas			
79100	100 mm	Grael	1	8421411024188
79155	150 mm	Grael	1	8421411024195

- (ES) Mini Sargentos de apriete rápido con mango soft antideslizante. Uso fácil y rápido con una sola mano. 2 posiciones de apriete: interior y exterior. Segmentos de apriete de 100 y 150 mm.
- (EN) Mini quick-release clamps with non-slip soft handle. Easy and fast to use with one hand. 2 clamping positions: interior and exterior. Clamping segments of 100 and 150 mm.
- (DE) Mini Schnellspannzwing mit rutschfestem Softgriff. Einfache und schnelle Einhandbedienung. 2 Spannpositionen: innen und außen. Spannsegmente von 100 und 150 mm.

# HERRAMIENTAS MANUALES - TORNILLOS DE BANCO

HAND TOOLS - VICES

HANDWERKZEUGE - SCHRAUBSTÖCKE



PINZAS DE APRIETE		REF.	Medidas	Apertura			
	78150	78050	50 mm	Apertura 25 mm	Ganel	1	8421411022726
	78100	78075	75 mm	Apertura 35 mm	Ganel	1	8421411022733
	78075	78100	100 mm	Apertura 45 mm	Ganel	1	8421411022740
	78050	78150	150 mm	Apertura 54 mm	Ganel	1	8421411022757

- (ES) Pinzas de apriete en plástico con mordazas basculantes anchas. Disponibles en tamaños de 50, 75, 100 y 150 mm.
- (EN) Plastic clamping pliers with wide hinged jaws. Available in sizes of 50, 75, 100, and 150 mm.
- (DE) Kunststoff-Halteklammern mit breiten schwenkbaren Backen. Erhältlich in den Größen 50, 75, 100 und 150 mm.

PINZAS DE APRIETE		REF.	Medidas			
	77150	77050	50 mm	Ganel	1	8421411022696
	77100	77100	100 mm	Ganel	1	8421411022702
	77050	77150	150 mm	Ganel	1	8421411022719

- (ES) Pinzas de apriete en metal. Mordazas recubiertas de goma.
- (EN) Metal spring clamps soft grip. Plastic covered jaws.
- (DE) Metall-Halteklammern. Backen mit Gummiüberzug.

TORNILLOS DE BANCO DE ACERO		REF.	A	B	Kg			
	M90	100 mm	125 mm	8,5	Caja	1	8421411007952	
	M91	125 mm	150 mm	13	Caja	1	8421411007969	
	M92	150 mm	200 mm	19	Caja	1	8421411007976	
	M93	175 mm	220 mm	25	Caja	1	8421411007983	

- (ES) Tornillos de banco en acero forjado. Disponibles en distintas medidas.
- (EN) Forged steel bench vises. Available in various sizes.
- (DE) Schraubstöcke aus geschmiedetem Stahl. Erhältlich in verschiedenen Größen.

TORNILLOS DE BANCO CON BASE GIRATORIA		REF.	A	B	Kg			
	M909	100 mm	125 mm	9,5	Caja	1	8421411024638	
	M919	125 mm	150 mm	13	Caja	1	8421411024645	
	M929	150 mm	200 mm	17	Caja	1	8421411024652	
	M939	175 mm	220 mm	25	Caja	1	8421411024669	

- (ES) Tornillos de banco con base giratoria. Disponibles en distintas medidas.
- (EN) Bench vises with swivel base. Available in various sizes.
- (DE) Schraubstöcke mit Drehsockel. Erhältlich in verschiedenen Größen.

# TORNILLOS DE BANCO - MORDAZAS

VICES - DRILLS

SCHRAUBSTÖCKE - MASCHINENSCHRAUBSTOCK

## BASE GIRATORIA PARA TORNILLO DE BANCO



REF.	∅ mm			
BG03	100 mm	Caja	1	8421411020968
BG05	125 mm	Caja	1	8421411020975
BG06	150 mm	Caja	1	8421411020982
BG07	175 mm	Caja	1	8421411020999

- Base giratoria para tornillo de banco en acero forjado. Disponible en distintas medidas.
- Swivel base for forged steel bench vise. Available in various sizes.
- Drehsockel für Schraubstock aus geschmiedetem Stahl. Erhältlich in verschiedenen Größen.

## TORNILLOS DE BANCO DE ACERO

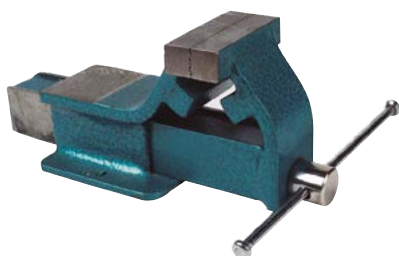

REF.						
N141	80 mm	100 mm	4	Caja	1	8421411007990
N142	110 mm	120 mm	6,5	Caja	1	8421411008003
N143	130 mm	140 mm	11	Caja	1	8421411008010
N144	150 mm	155 mm	15,5	Caja	1	8421411008027

- Tornillos de banco de acero. Ideales para sectores industriales. Disponibles en distintas medidas.
- Steel bench vises. Ideal for industrial sectors. Available in various sizes.
- Stahlschraubstöcke. Ideal für industrielle Bereiche. Erhältlich in verschiedenen Größen.

## YUNQUES



REF.					
T105	20	465 mm	Caja	1	8421411011287
T106	25	520 mm	Caja	1	8421411011294
T107	50	570 mm	Caja	1	8421411011300

- Yunques de fundición. Disponibles en distintas medidas.
- Cast iron anvils. Available in various sizes.
- Gusseiserne Ambosse. Erhältlich in verschiedenen Größen.

## TORNILLOS DE BANCO MINI CON BASE GIRATORIA



REF.						
M29	50 mm	30 mm	0,6	Caja	1	8421411022863

- Tornillo de banco mini. Disponible en 50 mm.
- Mini bench vise. Available in 50 mm.
- Mini-Schraubstock. Erhältlich in 50 mm.

## TORNILLOS DE BANCO MINI CON BASE GIRATORIA



REF.						
M39	50 mm	40 mm	1,6	Caja	1	8421411023365

- Tornillo de banco mini con base giratoria. Disponible en 50 mm.
- Mini bench vise with swivel base. Available in 50 mm.
- Mini-Schraubstock mit Drehsockel. Erhältlich in 50 mm.

# TORNILLOS DE BANCO - MORDAZAS

VICES - DRILLS

SCHRAUBSTÖCKE - MASCHINENSCHRAUBSTOCK



## TORNILLOS DE BANCO MINI PORTÁTIL

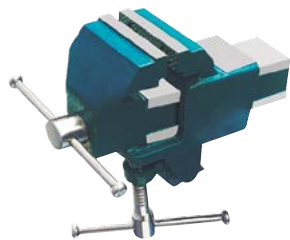

REF.	A	B	Kg			
<b>MJ70</b>	65 mm	80 mm	3,4	Caja	1	8421411023822

- (ES) Tornillo de banco mini portátil con estribo de sujeción para anclaje a mesa. Disponible en 65 mm.
- (EN) Portable mini bench vise with clamping bracket for table anchoring. Available in 65 mm.
- (DE) Tragbarer Mini-Schraubstock mit Klemmhalterung zur Tischbefestigung. Erhältlich in 65 mm.

## TORNILLOS DE BANCO TIPO GERMAN STANDARD

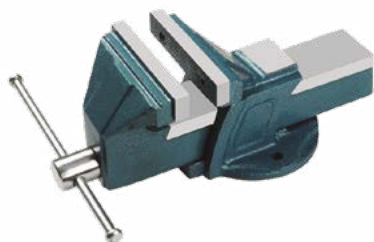

REF.	A	B	Kg			
<b>G80</b>	80 mm	90 mm	4	Caja	1	8421411023785
<b>G100</b>	100 mm	120 mm	7	Caja	1	8421411023792
<b>G125</b>	125 mm	150 mm	8	Caja	1	8421411023808
<b>G150</b>	150 mm	183 mm	15,5	Caja	1	8421411023815

- (ES) Tornillos de banco en acero forjado. Disponibles en distintas medidas.
- (EN) Forged steel bench vises. Available in various sizes.
- (DE) Schraubstöcke aus geschmiedetem Stahl. Erhältlich in verschiedenen Größen.

## TORNILLO DE BANCO CARPINTERO

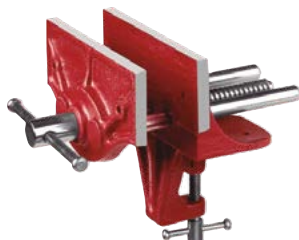

REF.	A	B	Kg			
<b>MC150</b>	150 mm	120 mm	2,9	Caja	1	8421411023839

- (ES) Tornillo de banco de carpintero portátil. Disponible en 150 mm.
- (EN) Portable carpenter's bench vise. Available in 150 mm.
- (DE) Tragbarer Schreiner-Schraubstock. Erhältlich in 150 mm.

## MORDAZAS DE TALADRO DE PRECISIÓN



REF.	A	B	Kg			
<b>E42</b>	80 mm	80 mm	4	Caja	1	8421411011218
<b>E43</b>	100 mm	90 mm	8	Caja	1	8421411011225
<b>E44</b>	135 mm	150 mm	16	Caja	1	8421411011232
<b>E45</b>	150 mm	180 mm	24	Caja	1	8421411011249

- (ES) Mordaza de taladro de precisión de alta calidad. Disponible en distintas medidas.
- (EN) High-quality precision drill vise. Available in various sizes.
- (DE) Hochwertiger Präzisions-Maschinenschraubstock. Erhältlich in verschiedenen Größen.

## MORDAZAS PARA TALADRO

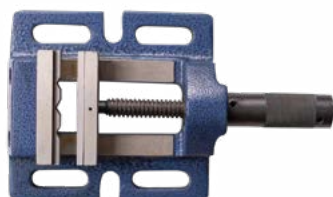

REF.	A	B	Kg			
<b>431001</b>	80 mm	65 mm	4	Caja	1	8421411011256
<b>431002</b>	100 mm	95 mm	5	Caja	1	8421411011263
<b>431003</b>	120 mm	120 mm	7,5	Caja	1	8421411011270

- (ES) Mordaza de taladro MT3. Disponible en distintas medidas.
- (EN) MT3 drill vise. Available in various sizes.
- (DE) Maschinenschraubstock MT3. Erhältlich in verschiedenen Größen.

# CAJAS DE HERRAMIENTAS Y ORGANIZADORES

TOOL BOXES AND ORGANIZERS

WERKZEUGKÄSTEN UND ORGANISATOREN

## CAJA DE HERRAMIENTAS DE ACERO INOXIDABLE

REF.

Medidas



2822

510 x 280 x 220 mm

8421411019627



- (ES) Caja de herramientas protegida con acero inoxidable. Tapa con acanalamiento en V, asa abatible bimaterial y cierres metálicos. En el interior se incluye una bandeja extraíble.
- (EN) Toolbox protected with stainless steel. V-groove lid, foldable bimaterial handle, and metal latches. Inside includes a removable tray.
- (DE) Werkzeugkasten aus Edelstahl. Deckel mit V-Nut, klappbarem 2K-Griff und Metallverschlüssen. Im Inneren befindet sich ein herausnehmbarer Einsatz.

## CAJA DE HERRAMIENTAS DE ALTA RESISTENCIA

REF.

Medidas



2823

557 x 283 x 245 mm

8421411022474



- (ES) Caja de herramientas de alta resistencia. Cierres y bisagra con pasador metálicos para mayor robustez. Protectores anti choque en los ángulos. Se puede cerrar con candado. Se incluye un organizador extraíble.
- (EN) High-strength toolbox. Metal latches and hinge for increased robustness. Shock-resistant protectors on the corners. Can be locked with a padlock. Includes a removable organizer.
- (DE) Robuster Werkzeugkasten. Metallverschlüsse und Scharnier für mehr Festigkeit. Kantenschutz. Kann mit einem Vorhängeschloss verschlossen werden. Enthält einen herausnehmbaren Sortimentskasten.

## ARCÓN DE TRANSPORTE

REF.

Medidas



2825

610 x 375 x 415 mm

Granel

8421411022498



- (ES) Arcón de transporte con dos bandejas de plástico interiores extraíbles. Gran capacidad, 610 x 375 x 415 mm.
- (EN) Transport chest with two removable inner plastic trays. Large capacity, 610 x 375 x 415 mm.
- (DE) Transportkiste mit zwei herausnehmbaren inneren Kunststofftablets. Großes Fassungsvermögen, 610 x 375 x 415 mm.

## ESTUCHE ORGANIZADOR DE ACCESORIOS

REF.

Medidas

Compartimentos



2725

415 x 330 x 55 mm

17

Granel

8421411022559



- (ES) Estuche organizador para accesorios de gran capacidad. Dispone de 17 cajones extraíbles de color amarillo de gran visibilidad. La tapa es transparente, lo que permite visualizar con facilidad el contenido. Contiene una asa para facilitar el transporte.
- (EN) High-capacity organizer case for accessories. Features 17 removable yellow drawers for high visibility. The lid is transparent, allowing easy visibility of the contents. Includes a handle for easy transport.
- (DE) Sortimentskoffer für Zubehör mit hohem Fassungsvermögen. Verfügt über 17 herausnehmbare gelbe Fächer. Der Deckel ist transparent, was eine einfache Sicht auf den Inhalt ermöglicht. Mit Griff für einen einfachen Transport.

## ESTUCHE ORGANIZADOR DE ACCESORIOS

REF.

Medidas

Compartimentos



2730

320 x 260 x 80 mm

24

Granel

8421411022566



- (ES) Estuche organizador doble para accesorios. Gran capacidad a doble cara. Dispone de compartimentos de dimensiones variables, con 24 divisores interiores de plástico. La tapa es transparente, lo que permite visualizar con facilidad el contenido. Contiene una asa para facilitar transporte.
- (EN) Double-sided organizer case for accessories. Large capacity on both sides. Features compartments of variable dimensions, with 24 plastic interior dividers. The lid is transparent, allowing easy visibility of the contents. Includes a handle for easy transport.
- (DE) Doppelter Sortimentskoffer für Zubehör mit hohem Fassungsvermögen. Verfügt über Fächer mit variablen Abmessungen und 24 innere Kunststoff-Trennwände. Der Deckel ist transparent, was eine einfache Sicht auf den Inhalt ermöglicht. Mit Griff für einen einfachen Transport.



# CAJAS DE HERRAMIENTAS Y ORGANIZADORES

TOOL BOXES AND ORGANIZERS

WERKZEUGKÄSTEN UND ORGANISATOREN



ESTUCHE ORGANIZADOR DE ACCESORIOS	REF.	Medidas	Compartimentos		
	2724	340 x 250 x 60 mm	15	Granel	8421411022542
<p>(ES) Estuche organizador de accesorios. Dispone de 15 cajones extraíbles, de color amarillo de gran visibilidad. El especial diseño de la tapa mantiene los cajones fijos. Asa para facilitar transporte. Tapa transparente, permite visualizar fácilmente el contenido.</p> <p>(EN) Professional Organizer. 15 Removable cup compartments in different sizes, in high visibility yellow colour. Wide handle for easy and stable portability. Lid design keeps storage cups locked in place. Transparent lid for easy location of the needed small parts.</p> <p>(DE) Sortimentskoffer für Zubehör. Verfügt über 15 herausnehmbare gelbe Fächer. Das spezielle Design des Deckels hält die Fächer an ihrem Platz. Gleichzeitig ist er transparent, was eine einfache Sicht auf den Inhalt ermöglicht. Mit Griff für einen einfachen Transport.</p>					

ESTUCHE ORGANIZADOR DE ACCESORIOS	REF.	Medidas	Compartimentos		
	2720	243 x 180 x 40 mm	9	Granel	8421411022504
<p>(ES) Estuche organizador para accesorios. Dispone de 9 compartimentos fijos. La tapa es transparente, lo que permite visualizar con facilidad el contenido. Con asa para facilitar transporte.</p> <p>(EN) Organizer case for accessories. Features 9 fixed compartments. The lid is transparent, allowing easy visibility of the contents. With handle for easy transport.</p> <p>(DE) Sortimentskoffer für Zubehör. Verfügt über 9 herausnehmbare Fächer. Der Deckel ist transparent, was eine einfache Sicht auf den Inhalt ermöglicht. Mit Griff für einen einfachen Transport.</p>					

ESTUCHE ORGANIZADOR DE ACCESORIOS	REF.	Medidas	Compartimentos		
	2721	330 x 250 x 53 mm	9	Granel	8421411022511
<p>(ES) Estuche organizador para accesorios. Dispone de 9 compartimentos fijos. La tapa es transparente, lo que permite visualizar con facilidad el contenido. Contiene una asa para facilitar transporte.</p> <p>(EN) Organizer case for accessories. Features 9 fixed compartments. The lid is transparent, allowing easy visibility of the contents. Includes a handle for easy transport.</p> <p>(DE) Sortimentskoffer für Zubehör. Verfügt über 9 herausnehmbare Fächer. Der Deckel ist transparent, was eine einfache Sicht auf den Inhalt ermöglicht. Mit Griff für einen einfachen Transport.</p>					

ESTUCHE ORGANIZADOR DE ACCESORIOS	REF.	Medidas	Compartimentos		
	2722	510 x 325 x 65 mm	17	Granel	8421411022528
<p>(ES) Estuche organizador para accesorios. Dispone de 17 compartimentos de dimensiones variables. La tapa es transparente, lo que permite visualizar con facilidad el contenido. Contiene una asa para facilitar transporte.</p> <p>(EN) Accessory organizer case. Features 17 compartments of variable dimensions. The lid is transparent, allowing easy visibility of the contents. Includes a handle for easy transport.</p> <p>(DE) Sortimentskoffer für Zubehör. Verfügt über 17 herausnehmbare Fächer. Der Deckel ist transparent, was eine einfache Sicht auf den Inhalt ermöglicht. Mit Griff für einen einfachen Transport.</p>					

# PORTA - HERRAMIENTAS

TOOL HOLDERS

WERKZEUGHALTER

## CARTUCHERAS Y CUELGA-FLEXÓMETROS EN PIEL



REF.	Descripción	Material	M. Exterior		
9998	Cartuchera	Piel	190 x 140 mm	1	8421411023082
9999	Cartuchera	Piel	150 x 100 mm	5	8421411010471
99995	Cuelga-flexómetros	Piel	130 x 90 mm	5	8421411012208

- Cartuchera porta-flexómetros y cuelga-flexómetros en piel con soporte metálico.
- Leather tape measure holder and hanging flexometer with metal support.
- Metall-Bandmaßhalter aus Leder für Rollbandmaße.

## PORTA-MARTILLOS Y PORTA-HERRAMIENTAS EN PIEL



REF.	Descripción	Material	M. Exterior		
9990	Porta-martillos	Piel	120 x 145 x 65 mm	1	8421411023075
9991	Porta-herramientas	Piel	90 x 215 x 35 mm	10	8421411023099

- Porta-martillos y porta-herramientas en piel con soporte metálico.
- Hammer holder and tool holder in leather with metal support.
- Werkzeughalter aus hochwertigem Leder.

## PORTA-HERRAMIENTAS EN NYLON MULTI-BOLSILLOS



REF.	Descripción		Material		
9985	Porta-herramientas	5 bolsillos	Nylon	1	8421411023761
99810	Porta-herramientas	10 bolsillos	Nylon	1	8421411023778

- Porta-herramientas multi-bolsillos fabricado en nylon.
- Multi-pocket tool holder made of nylon.
- Werkzeughalter aus Nylon mit mehreren Taschen.

## PORTA-HERRAMIENTAS EN PIEL MULTI-BOLSILLOS



REF.	Descripción		Material		
9995	Porta-herramientas	5 bolsillos	Piel	1	8421411023068
99910	Porta-herramientas	10 bolsillos	Piel	1	8421411023051

- Porta-herramientas multi-bolsillos fabricado en piel.
- Multi-pocket tool holder made of leather.
- Werkzeughalter aus Leder mit mehreren Taschen.

## FUNDA PORTA-CUTTER DE NYLON



REF.	Compartimentos			
880	2	Caja	1	8421411024799

- Funda porta-cutter de nylon. Color negro. Con remache para colgar en el cinturón. Tiene dos compartimentos, ideales para cutter y accesorios como cuchillas de recambio.
- Nylon cutter holder. Black color. With a rivet for hanging on the belt. It has two compartments, ideal for cutter and accessories such as spare blades.
- Nylon-Cuttertasche. Schwarze Farbe. Mit Niete zum Aufhängen am Gürtel. Ausgestattet mit zwei Fächern, ideal für Cutter und Zubehör wie Ersatzklingen.







# REFERENCIAS / REFERENCES / ARTIKELNUMMER

REF.	Pag	REF.	Pag	REF.	Pag	REF.	Pag	REF.	Pag	REF.	Pag	REF.	Pag		
31	55	503	101	898	101	2408	104	5011	47	6510	40	8395	116	25050	74
32	55	504	104	899	101	2504	104	5012	23	6522	18	8629	61	25060	74
34	55	505	96	908	100	2508	104	5014	23	6528	18	8639	61	25080	74
35	55	506	104	909	101	2515	22	5016	91	6530	40	8739	61	25100	74
53	34	508	103	912	100	2516	91	5017	91	6532	41	8759	61	25351	16
56	34	520	40	915	101	2517	91	5018	91	6610	38	9013	21	25537	16
58	34	521	41	930	45	2518	91	5019	91	6828	18	9019	110	25541	16
66	34	525	96	941	53	2519	91	5033	90	7150	56	9025	110	25550	16
68	34	566	52	966	99	2720	127	5036	90	7163	18	9028	110	27030	72
84	24	590	81	990	23	2721	127	5110	64	7166	88	9090	94	27040	72
040	75	591	81	995	57	2722	127	5130	65	7200	56	9150	56	27050	72
162	92	592	81	1011	102	2724	127	5250	56	7203	77	9163	15	27060	72
169	57	593	81	1018	48	2725	126	5310	65	7250	56	9164	57	27080	72
175	92	595	81	1021	102	2730	126	5330	62	7255	18	9195	15	27100	72
180	81	603	101	1025	102	2810	94	5393	22	7258	18	9200	56	27120	72
184	57	680	89	1050	46	2811	94	5401	62	7528	18	9203	57	27150	72
185	31	681	78	1086	102	2812	94	5417	22	7828	18	9250	56	30008	54
190	92	682	78	1087	102	2814	94	5501	63	7903	46	9253	19	33226	72
193	57	683	78	1088	102	2815	94	5505	63	7904	46	9256	19	33412	87
208	103	703	99	1100	92	2816	94	5506	64	7905	46	9271	57	33413	87
218	48	720	77	1122	117	2817	94	5507	63	7953	81	9273	57	36057	77
222	55	721	77	1125	93	2822	126	5509	64	7971	89	9310	19	40020	46
250	81	722	77	1181	84	2823	126	5515	66	7972	89	9496	89	40804	104
255	81	770	78	1191	84	2825	126	5610	65	7973	89	9985	128	40825	104
300	81	772	78	1201	84	3011	47	5615	65	7975	89	9990	128	40840	104
308	103	780	89	1290	80	3048	45	5631	60	7976	89	9991	128	40860	104
318	48	782	79	1330	92	3061	45	5632	60	8005	115	9995	128	40880	104
331	88	783	79	1511	47	3180	81	5661	60	8006	115	9998	128	43191	14
333	88	790	82	1530	92	3205	15	5662	60	8008	115	9999	128	43195	14
334	87	791	82	1550	93	3208	15	5663	59	8009	115	10008	54	45191	14
340	75	795	81	1690	81	3250	81	5665	59	8010	37	10013	54	45195	14
341	81	796	81	1695	87	3300	81	5821	42	8011	115	10018	91	45251	14
345	81	797	81	1772	88	3552	54	5822	42	8012	115	10020	54	45255	14
361	77	803	99	1815	51	3600	46	5841	64	8019	110	11889	54	50025	46
362	77	811	100	1820	51	3603	77	5863	42	8020	39	15040	74	58403	63
363	77	812	100	1897	101	4040	48	5882	42	8021	39	15050	74	58453	63
371	78	813	100	1910	51	4050	84	5900	62	8028	116	15060	74	60003	16
373	78	818	98	1912	102	4080	79	5901	63	8030	38	16040	70	60030	46
381	84	820	98	1918	91	4081	79	5989	41	8040	37	16060	70	61020	122
382	84	823	80	1935	15	4082	79	6008	114	8041	37	16080	70	61025	122
383	84	824	80	2000	48	4091	86	6009	114	8050	38	16100	70	61030	122
391	84	831	80	2002	48	4092	86	6018	114	8064	36	17040	69	70003	19
392	84	834	80	2009	48	4093	86	6019	114	8067	35	17050	69	70005	19
393	84	866	99	2010	72	4094	86	6028	115	8075	34	17060	69	70008	19
403	101	875	104	2012	48	4095	86	6029	114	8080	39	18700	80	71062	47
408	103	876	104	2016	51	4096	86	6040	46	8150	56	18701	80	71065	47
409	42	877	104	2019	49	4099	86	6125	117	8163	17	18703	80	72005	82
410	103	880	128	2022	48	4200	56	6133	17	8193	17	18705	80	72250	105
419	42	885	96	2030	48	4474	85	6220	122	8195	17	18711	80	72251	105
440	71	886	98	2040	48	4479	85	6221	122	8200	56	20008	54	72252	105
460	85	887	98	2048	45	4581	105	6319	18	8221	35	20013	54	73040	69
461	85	888	98	2049	45	4582	105	6361	87	8250	56	20020	54	73060	69
462	85	890	98	2050	45	4583	105	6362	87	8255	17	20118	84	73080	69
463	85	892	97	2051	45	4584	105	6363	87	8308	17	20409	86	73114	120
465	85	893	97	2100	57	4591	105	6365	81	8310	36	20460	85	73150	120
466	85	894	97	2217	50	4600	105	6401	53	8311	36	20469	85	73175	120
467	85	895	97	2220	50	4710	88	6402	53	8313	116	22730	70	73185	120
491	50	896	101	2308	102	4715	88	6403	53	8320	35	25030	74	74150	116
500	94	897	101	2350	50	5003	64	6500	41	8365	116	25040	74	74200	116

# REFERENCIAS / REFERENCES / ARTIKELNUMMER

REF.	Pag	REF.	Pag	REF.	Pag	REF.	Pag	REF.	Pag	REF.	Pag	REF.	Pag	REF.	Pag
74201	116	81115	108	213210	49	900150	67	17040M	69	8308MP	17	CT200	50	NF220200130	55
74250	116	82371	53	254101	52	900200	67	17050M	69	84	24	CTR	50	NF220250160	55
74251	116	87339	61	254102	52	1775100	28	17060M	69	8425M	20	CV100	103	NF22110070	55
74301	116	90060	67	264020	30	2001000	93	177530N	28	8425MMP	20	CV200	103	NF221150100	55
75175	121	90080	67	264030	30	2675100	31	177550N	28	900100M	67	DA11560	106	NF221200130	55
75230	121	99012	25	264050	30	2760100	31	197550	28	900150M	67	DA12560	106	NF221250160	55
76230	121	99193	19	265020	30	3413100	112	2217T	50	900200M	67	DA18070	106	P1000B	94
76250	121	99255	19	265030	30	3430100	112	2220T	50	90060M	67	DA23080	106	P1000BR	94
77044	78	99308	19	265050	30	3430125	112	2226.01	53	90080M	67	DM100	52	P1336B	94
77050	123	99810	128	266030	31	3433100	112	2226.02	53	908B	100	DM125	52	P224B	94
77060	67	99910	128	266050	31	100.S10	83	2226.04	53	99001	24	DM150	52	P336B	94
77080	67	99995	128	268020	30	100.S12	83	23060M	68	A030	82	DM175	52	P3500B	94
77100	123	100050	46	268030	30	100.S2	83	23080M	68	A040	82	E42	125	P4B	94
77110	71	100500	93	268050	30	100.S3	83	23100M	68	A050	82	E43	125	P4BR	94
77150	123	100700	93	276050	31	100.S4	83	23150M	68	A060	82	E44	125	SC03	73
77910	71	102005	54	291530	32	100.S5	83	2350T	50	A080	82	E45	125	SD021	118
77925	70	102006	54	294030	32	100.S6	83	264010MP	30	A100	82	ESY300	45	SD029	119
77940	68	105102	47	296110	32	100.S8	83	264020MP	30	B1	75	G-03	54	SD-038	119
77960	68	105103	47	296120	32	1001000M	93	264030MP	30	B2	75	G100	125	SD045	119
77980	68	105104	47	296130	32	100500M	93	264050MP	30	B3	75	G125	125	SD051	118
78032	79	105105	47	314500	66	100700M	93	27040M	72	B316	21	G150	125	SG115	107
78050	123	105106	47	342415	111	101.S10	83	27050M	72	B316M	21	G80	125	SG230	107
78075	123	105107	47	342416	111	101.S12	83	27060M	72	B519	21	100I	25	SP115	107
78100	123	105108	47	342471	112	101.S2	83	27200M	72	B519M	21	LA115AN60	106	SP125	107
78150	123	105109	47	342486	111	101.S3	83	33	55	B525	21	LA115AN80	106	SP230	107
79100	122	105601	47	343015	111	101.S4	83	334S	87	B525M	21	LA515AN40	106	T105	124
79150	122	105602	47	343016	111	101.S5	83	3419M	20	B825	21	L1115ZN40	107	T106	124
79155	122	105603	47	343045	112	101.S6	83	3419MMP	20	B825M	21	L1115ZN60	107	T107	124
79300	122	105604	47	343315	111	101.S8	83	373-E	57	BC115	108	L1115ZN80	107	T-300	53
79450	122	136020	27	343316	111	1011PRO	102	39/4	90	BC230	108	M100025	52	T-550	53
80040	46	136030	27	343332	112	1021PRO	102	39/40	90	BG03	124	M1002550	52	TBW	24
80106	109	136050	27	343337	111	1025PRO	102	39/6	90	BG05	124	M1005075	52	TG115	107
80108	109	140010	28	343383	112	1083GPRO	102	39/60	90	BG06	124	M10075100	52	TG230	107
80110	109	140020	28	343556	111	1083GPRO	102	40/10	90	BG07	124	M29	124	TORPEDO 300	74
80112	109	140025	28	408100	104	1083PRO	102	431003	125	C582	51	M39	124	TP115	107
80116	109	140030	28	408120	104	1083PRO	102	431003	125	C583	51	M90	123	TP125	107
80120	109	140050	28	431001	125	121010D	29	50/1	90	CA11530	106	M909	123	TP230	107
80127	109	166040	27	431002	125	121010	29	5250A	56	CA12530	106	M91	123	TTB	24
80135	109	166060	27	480000	73	121010GF	29	5330SET	62	CA18030	106	M919	123	WA302	118
80140	109	197530	28	490045	73	121015	29	5401SET	62	CA23030	106	M92	123	WA702	118
80150	109	200700	93	572000	43	121015GF	29	5419M	20	CDC115	108	M929	123	WAPE402	117
80160	109	201300	23	582000	43	121020D	29	5419MMP	20	CDC125	108	M93	123	WAP402	117
80168	109	201301	23	585000	44	121020	29	5900SET	62	CDC230	108	M939	123	XX115	108
80175	109	201303	23	589404	63	121020GF	29	60/1	90	CDE	49	MC150	125		
80186	109	201304	23	591000	43	121025	29	60003Z	16	CDM115	108	MD9202	57		
80195	109	201305	23	592000	43	121025GF	29	60005Z	16	CDM125	108	MJ70	125		
80206	109	201306	23	593000	44	121030D	29	77060M	67	CDM230	108	N030	82		
80208	109	201325	23	595000	44	121030	29	77940M	68	CI11510	106	N032	75		
80210	109	204080	79	779100	68	121030GF	29	77960M	68	CI2510	106	N040	82		
80212	109	204094	86	779150	68	121050D	29	77980M	68	CI18016	106	N050	82		
80306	109	204474	85	779200	68	121050	29	798A	89	CI23018	106	N060	82		
80308	109	213103	50	803014	109	121050GF	29	798AM	89	CL-1025	20	N080	82		
80310	109	213106	50	805412	110	130	92	798R	89	CL-1219	20	N100	82		
80312	109	213109	50	805413	110	140010MP	28	80245S	69	CL-1313	20	N141	124		
80404	111	213112	50	880032	91	140020MP	28	8162MP	17	CL-1313SF	20	N142	124		
80406	111	213116	50	880050	91	140030MP	28	8163MP	17	CL-1319	20	N143	124		
80408	111	213200	49	900030	91	140050MP	28	8193M	17	CL-1519	20	N144	124		
80410	111	213203	49	900050	91	166040MP	27	8195M	17	CL-1525	20	NF22010070	55		
80412	111	213205	49	900100	67	166060MP	27	8255MP	17	CL-1825	20	NF220150100	55		







#### Ventas

Tels.: 933 190 966 / 933 190 681

E-mail: [ventas@medid.es](mailto:ventas@medid.es)

#### Export

Tel.: (+34) 933 190 450

E-mail: [export@medid.es](mailto:export@medid.es)

#### Logística

Tel.: 935 601 418

E-mail: [logistica@medid.es](mailto:logistica@medid.es)



[www.medid.es](http://www.medid.es)

#### GENERAL DE MEDICIÓN, S.L.

C/ Montcada, 19

Pol. Ind. Camp de les Pereres

08130 Santa Perpètua de Mogoda

BARCELONA (Spain)

