

WORK LIGHTS

LIGHTING SOLUTIONS
FOR HIGH PERFORMANCE

2024





LIGHTING SOLUTIONS FOR HIGH PERFORMANCE

Work light of the future

The sophisticated SCANGRIP work lights are second-to-none and made for the real professional who needs the best tool he can get for the task. The full product line-up covers all kinds of work light solutions with superior quality across the entire range. These are lights made for work and built to last.

Latest technologies for best performance

SCANGRIP constantly push back the boundaries of LED lighting and battery technology, creating new cutting-edge work lights. We always reach for that extra brightness, that extra operation time, those little touches that make a real difference when you need the best work light you can get. We guarantee to provide you with only premium products for optimal performance.

Extreme durability and functional design

SCANGRIP work lights are extremely durable and made to last and do the job again and again. The entire product line is sturdy and endures the

really demanding working environment which expose both the professional worker and his tools to rough, wet, and dirty conditions. The lights are covered by a high IP protection level to resist even outdoor use in all kinds of weather.

All our lighting solutions are developed to be energy saving and with a long lifetime

Whether you compare energy efficiency with traditional technologies or other LED products, you will save energy by choosing a SCANGRIP work light. The LED PERFORMANCE indicates the actual light output of the LED in a SCANGRIP work light and we aim for the highest number to achieve less power consumption compared to other solutions on the market.

Extended warranty

Our lights meet the highest quality standards and are built to last. They are so good that we offer a warranty extension. All SCANGRIP work lights come with a 3-year warranty. Because we stand by the products we offer.

Designed by us. Manufactured by us.

3
years
warranty

PATENT PROTECTED

SCANGRIP - work lights of the future

| | | | | |
|---|---|---|---|---|
|  |  |  |  |  |
| MAG series 04 | UNIFORM series 06 | SLIM series 08 | STICK LITE series 10 | STARLITE 12 |
|  |  |  |  |  |
| LINE LIGHT hand lamps 14 | Bonnet lights 16 | Headlamps 20 | STAR 26 | NOVA series 28 |
|  |  |  |  |  |
| VEGA LITE series 36 | AREA LITE CO 38 | STANDS and SUSPENSIONS 40 | SITE LIGHT series 42 | ROPE LIGHT 44 |
|  |  |  |  |  |
| FLEX WEAR 46 | FLASH LIGHT series 47 | LINE LIGHT concept 50 | LINE LIGHT for lifts 52 | LINE LIGHT for customized installation 54 |



MAG – Europe's most bestselling work lights even further improved

// The rechargeable handheld work lights everybody knows – and loves! With significantly improved light output, battery upgrade and even more functionality, the popular MAG work lights offer great value in every workshop operation.

The MAG series consist of universal and powerful multipurpose work lights that all professional users must have!

- Significantly improved with higher lumen output
- Integrated work light and flashlight functionality in one
- Strong built-in magnetic holders and retractable hooks for handsfree operation
- New stepless dimmer function

// MAG PRO WIRELESS - more flexibility with wireless charging

MAG PRO comes in a version with the option of wireless charging using the accessory SCANGRIP CHARGING PAD 03.5928, which can be purchased separately. The charging pad offers a convenient and uncomplicated way to charge your work light without the need for extra cables.

The charging pad is designed so that the work light automatically “slides into place” over the powerful magnets on the back. This means that MAG PRO WIRELESS can be charged also in a vertical position. The charging pad is prepared for fixed mounting, enabling efficient use of space in the workshop.

MAG PRO WIRELESS

€ 74.90

03.5691

Work light with COB LEDs and spotlight providing 600 lumen

NEW

CHARGING PAD

€ 29.90

03.5928

Optional accessory for MAG PRO WIRELESS. Can also be used for charging most mobile phones and other compatible devices.

NEW

ORIGINAL
SCANGRIP



SINCE 1906

3

years
warranty

PATENT PROTECTED

// Updated and more powerful than ever

Taking advantage of the latest high performance LED technology, the MAG range comprises extremely powerful work lights providing significantly improved light output. Compared to the previous MAG 3 and MINI MAG, the new MAG PROs are upgraded to IP54 and have a new design with battery indicator on front.

// Multipurpose with cool design

The characteristic and elegant design of the MAG hand lamps provides an ergonomic and user-friendly grip. Place anywhere you want with the strong built-in magnetic holders and retractable suspension hooks to obtain complete flexibility. The lamp head is flexible and tilts up to 180 degrees.

// Stepless dimmable



MAG PRO, MINI MAG PRO and MAG PEN 3 are upgraded with a stepless dimmer function in the range of 10 to 100 % that enables you to adjust the light output to the work task.

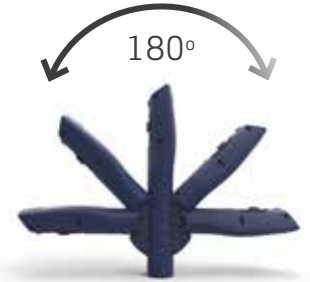

MAG
€ 52.90
03.5400

Work light with SMD LEDs and spotlight providing 300 lumen

EU DESIGN PATENT
2954123



MAG PRO
€ 64.90
03.5690

Work light with COB LEDs and spotlight providing 600 lumen

EU DESIGN PATENT
2954123



MINI MAG PRO
€ 42.90
03.5692

Work light with COB LEDs and spotlight providing 200 lumen

EU DESIGN PATENT
3451038



MAG PEN 3
€ 37.90
03.5116

Pencil work light with COB LEDs and spotlight providing 150 lumen

EU DESIGN PATENT
4070035



// Rechargeable inspection penlight

Upgraded with the highly efficient COB LED technology, MAG PEN 3 provides powerful illumination both from the lamp head and precision top light.

The design is compact allowing access in the most inaccessible places. It comes with built-in magnets both in the turnable clips and at the bottom for flexible positioning.

UNIFORM – extremely durable work lights

// Upgraded to highest possible performance

SCANGRIP is introducing upgraded and improved versions of the entire UNIFORM work light series.

The COB LED strip lights provide a unique, powerful and completely uniform illumination which is ideal for all demanding work operations.

The entire series has also been upgraded to IP65

- Rechargeable COB LED work light series
- Completely uniform and powerful illumination
- Extremely durable and sturdy
- Waterproof, IP65
- Rechargeable with USB cable



3
years
warranty

PATENT PROTECTED



UNIFORM
€ 89.90

03.5407

Work light with top flashlight providing up to 500 lumen

Extremely durable work lamp

In this product range UNIFORM is the big brother offering all the functionality you can dream of. Soon it will become your favourite, multifunctional work light. Extremely durable and powerful.

An intelligent battery indicator at the front keeps you informed about the battery level. 2-step operating option: Step 1 = 100 %, step 2 = 50 % light output.

EU DESIGN
PATENT
2954123

Slim charging
base for easy wall
mounting





UNIPEN
€ 45.90
03.5420

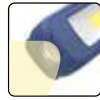

Pencil work light providing up to 150 lumen with top flashlight

Small and handy shape, supplied with pocket clip and 2-step operating option

EU DESIGN PATENT 3451038



ONLY 13 mm



MINIFORM
€ 56.90
03.5404



Pocket-sized, ultra-slim work light with top flashlight providing up to 200 lumen

With comfortable and ergonomic grip and 2-step operating option

EU DESIGN PATENT 5597010

Flexible lamp head tilts up to 180 degrees. Supplied with a strong built-in magnet and a turnable sturdy hook designed to fit the work belt.



SUPERFORM
€ 61.90
03.5406

Sturdy work light with 5 m cable providing 750 lumen

Outperforming traditional fluorescent work lights

EU DESIGN PATENT 2954123



UV-FORM
€ 79.90
03.5408

EU DESIGN PATENT 3451038



Work light with UV-top light (400 nm) providing up to 250 lumen



UV-FORM is a rechargeable LED work light with powerful 1.8 W UV-light on the top. The most powerful UV-light on the market. Basically you get a universal indispensable work light and UV detection in one, and at the same time it replaces special UV detection lights.

The ultraviolet light is intended for leak detection in air-conditioning systems by means of trace elements. Also useful for leak detection of larger, complex refrigeration/freezing appliances, process cooling systems, heat pump systems etc.

SLIM – only 3-in-1 slim light on the market

// The SCANGRIP SLIM light series provides a true three-in-one, flexible and multifunctional work light for all kinds of application areas.

- 3-in-1: inspection light, work light and flashlight in one lamp
- Extremely powerful illumination up to 500 lumen with a powerful flashlight function
- Ultra-slim and compact design
- Strong built-in magnet and hook for flexible positioning
- Choose between 2 light settings (50 % or 100 %) for maximized operating time
- Rechargeable up to 6 h operation time





// Ultra-slim light for inspection

The ultra-thin, compact design only $\varnothing 9$ mm allows inspection in even the most inaccessible and narrow work areas. This makes the SLIM lights ideal for very demanding and difficult inspection jobs.



// Work light in pocketsize

The 2 new SLIM lights are designed with a 100 % foldable body. When fully folded the lamp can be used as a traditional handheld work light. In folded position, the SLIM is reduced to pocketsize - compact and portable to take with you everywhere.



// Flashlight function

The powerful 100 lumen spot light of the SLIM lights provides you with a flashlight function. As a unique feature, never seen before, SLIM can be used as flashlight when the lamp is folded, providing a powerful flashlight with a handy, firm grip.



EU DESIGN
PATENT
3451038



MINI SLIM
€ 62.90
03.5610

Ultra-slim 3-in-1 inspection lamp with spotlight providing up to 200 lumen



SLIM
€ 77.90
03.5612

Ultra-thin 3-in-1 inspection lamp with spotlight providing up to 500 lumen



STICK LITE

// Universal hand lamps in slim design

STICK LITE is ideal for those who value good, compact design combined with uncomplicated functionality.

Taking advantage of the highly efficient COB LED technology, the new generation of STICK LITEs provides high performance regardless if it is for everyday use or a tough job. With STICK LITE, you are guaranteed optimal brightness and handy design at a fair price.

- Powerful work light with top light function
- Adjustable light output with stepless dimmer function
- Ultra lightweight for maximum working comfort
- Slim and compact design prepared for the pocket
- Strong built-in magnets for handsfree use

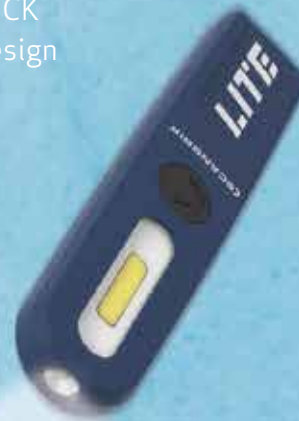

ORIGINAL
SCANGRIP



SINCE 1906

3
years
warranty

PATENT PROTECTED

// Handy work lights with fundamental features

STICK LITEs are rechargeable, powerful work lights with torch light function enabling convenient and precise work. STICK LITEs are recommended for everyone who need universal, sturdy and handheld work lights. The practical built-in magnets allow you to benefit from the bright light of the STICK LITEs and still having both hands free for work.

// Ultra lightweight and compact design

The ultra-thin and compact design with round shapes makes STICK LITE comfortable to carry in the pocket ready at hand for the daily inspection tasks. The slim designed work lights are also optimized in weight to provide maximum working comfort.

// Stepless dimmable



The STICK LITE hand lamps are upgraded with a stepless dimmer function in the range of 10 % to 100 % that enables you to easily adjust the light output to the work task.



Ultra-slim, only
13 mm wide



STICK LITE S

€ 24.90

03.5665

Rechargeable work light with top light and stepless dimmer providing up to 200 lumen



STICK LITE M

€ 34.90

03.5666

Rechargeable work light with top light and stepless dimmer providing up to 400 lumen



With strong built-in magnets for positioning on any magnetic surface

STAR LITE

// Universal inspection work light with cable

If you prefer a basic, traditional inspection work light with cable that does the job, STAR LITE is the perfect choice. It is designed for basic inspection work which is carried out at almost any workplace.

Upgraded with the highly efficient COB LED technology, STAR LITE ensures super bright illumination of the work area.



ORIGINAL
SCANGRIP



SINCE 1906

3
years
warranty

PATENT PROTECTED

EU DESIGN
PATENT
2532929



// Bright inspection work light

STAR LITE is the universal, sturdy work light everyone must have as part of the basic equipment of the workshop. It is designed for efficient workshop use and provides an ergonomic and user-friendly design. STAR LITE is fitted with a turnable hook for easy suspension of the lamp.



STAR LITE

€ 34.90

03.5671

Work light with cable
providing 400 lumen



ULTRA SLIM inspection hand lamps

// The sophisticated and streamlined LINE LIGHT inspection hand lamps are made in Denmark, and present a golden example of our ability to push back the boundaries of LED lighting creating work lights with optimal performance, extreme durability and lots of bright functionalities.

- Sturdy and waterproof, IP65
- Ultra-slim design (ø25 mm) allows inspection in even most inaccessible places
- Flexible positioning with adjustable hook with magnet
- Flexible gooseneck fixtures available as optional accessories

ORIGINAL
SCANGRIP



SINCE 1906

MADE IN DENMARK

3
years
warranty

PATENT PROTECTED



EU DESIGN
PATENT
4070035



Both lamps are delivered with adjustable hook with clip holder and magnet

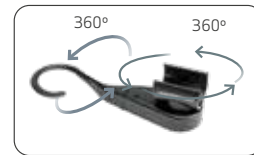

LINE LIGHT C+R

€ 104.90

03.5243

Inspection work lamp with DUAL SYSTEM and top spotlight providing up to 900 lumen



LINE LIGHT R

€ 92.90

03.5244

Rechargeable inspection work lamp with spotlight providing up to 600 lumen

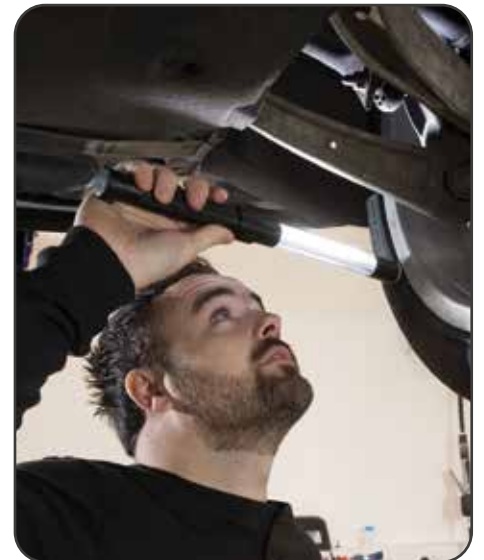

The very slim design with a diameter of only 25 mm makes it possible to illuminate even hard to reach compact areas.

DUAL 2 in 1 SYSTEM

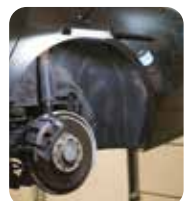

LINE LIGHT *bonnet light*

// Superior bonnet light on the market

- Improved light output (1400 lumen)
- Dust and waterproof, IP65
- Most slim and compact bonnet light on the market
- Extremely low weight, less than 1000 g
- Choose between 2 light settings (50 % or 100 %) for maximized operating time

DUAL 2 in 1 **SYSTEM**

DUAL SYSTEM is new intelligent and innovative lighting functionality.

The new BONNET LIGHT is with DUAL SYSTEM which means both rechargeable and with 5 m rubber cable offering unlimited application possibilities and complete freedom. Very easily you change over: it takes only a second to connect the power cable – or disconnect when needed.



ORIGINAL
SCANGRIP



SINCE 1906

MADE IN DENMARK

3
years
warranty

PATENT PROTECTED

EU DESIGN
PATENT
4070035

// Illuminates the entire engine bay

The BONNET LIGHT provides you with an extremely bright and powerful illumination of the entire engine bay.

Supplied with an adjustable telescopic holder with soft-padded hook ends providing a firm and scratch-free grip on the vehicle. The holder is compact and takes up less space in storage.



Without cable the bonnet light might also to be used as a large inspection lamp.



LINE LIGHT BONNET C+R

€ 169.90

03.5240

DUAL 2 in 1 SYSTEM



Inside the cabin the BONNET LIGHT may also be used as work light either mounted by the telescopic holder or mounted onto the windscreen by the flexible arm with suction cup.



// FLEXIBLE suspensions

A range of accessories are available to position the LINE LIGHT lamps



GOOSENECK

€ 26.90

03.5219

20 cm flexible arm with clip holder and ø60 mm suction cup



GOOSENECK

€ 31.90

03.5218

20 cm flexible arm with clip holder and ø60 mm magnet

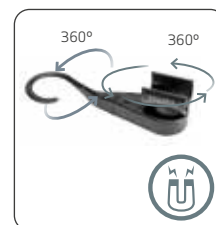

HOOK

€ 11.90

03.5312

Adjustable hook with clip holder and magnet

NOVA BONNET – *powerful bonnet light providing maximum flexibility*

// The NOVA BONNET light provides you with increased flexibility and bright illumination of the engine bay. With the NOVA BONNET, you will have a bonnet light and a flexible NOVA R hand lamp in one single solution.



Use the NOVA BONNET inside the cabin



Use NOVA R separately for inspection work



3
years
warranty

PATENT PROTECTED

// Rechargeable and dimmable COB LED work light

Easily mount the NOVA R on the bonnet light via the enclosed bracket, slide it from side to side to position the light and adjust the light output or simply use the hand lamp for inspection work.

Featuring the latest high-performance COB LED technology, NOVA R provides up to 2000 lumen with a uniform and even illumination. The light dimmer function makes it possible to adjust the light into five different levels, and due to the upgraded battery capacity, you can use the lamp for up to 20 hours depending on the light output.

The NOVA BONNET is supplied with an adjustable telescopic holder (1.2-1.7 m) with soft-padded hook ends providing a firm and scratch-free grip on the vehicle. The holder is compact and equipped with a metal bracket. The powerful integrated magnets of NOVA R provides flexible mounting on the bracket. Inside the cabin, the NOVA BONNET may also be used as work light mounted by the telescopic holder.

// High flexibility

The simple and user-friendly design makes it easy to mount and dismount the NOVA R, which allows you to use the lamp for inspection work. NOVA R is easy to carry and is ergonomically designed for a good grip on the handle.



Mount and dismount NOVA R on the bracket



NOVA BONNET

€ 149.90

03.5457

// ACCESSORIES

Buy accessories separately and transform your NOVA R handlamp into a flexible bonnet light.

BRACKET

€ 21.90

03.5760



BONNET HOLDER

€ 42.90

03.5314

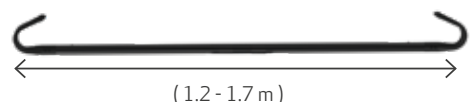

(1.2 - 1.7 m)



NOVA R 1000 / 2000 lumen

HEADLAMPS *for professionals*

// Pursuing the vision of designing innovative work light for the professional end-user

- Illuminates your entire workspace
- Rechargeable
- Long duration time
- Easy to operate
- Sensor function with touchless on/off switch

As opposed to all other headlamps providing a beam of light, the new I-VIEW and ZONE headlamps are designed to provide optimum work light illuminating your entire work area.

Supplied with the newest COB LED technology, both headlamps provide an extremely powerful illumination which spreads the uniform light to the maximum and lightens up your entire field of view.

You avoid turning the head to illuminate your actual workspace from a limited headlamp beam.

ORIGINAL
SCANGRIP



SINCE 1906

NEW

// ZOOM - Rechargeable headlamp with 3-step function

ZOOM is a small, compact yet very powerful headlamp providing 220 lumen and with a remarkable low weight of only 100 g.

The beam angle can be adjusted from 10° to 60° providing a beam distance up to 80 m.

The light output is adjustable in three steps and a new feature is the »READING MODE setting«, which provides just enough light to read and enables 19 hours of operating time.

ZOOM comes in a compact design and the light can be tilted 45° to obtain the optimum lighting angle.

ZOOM

€ 29.90

03.5627



Reading mode setting
Step 1

3-STEP FUNCTION



Adjustable lamp head



Adjustable beam
angle 10°-60°

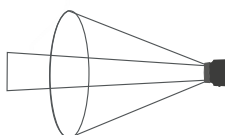

Up to 80 m

3
years
warranty

PATENT PROTECTED

I-VIEW
€ 71.90
03.5626

EU DESIGN
PATENT
2635946



// Rechargeable I-VIEW with touchless sensor



I-VIEW is upgraded with the very newest rechargeable battery technology, providing extremely powerful illumination up to 400 lumen in a new modern design. When set on sensor mode I-VIEW is switched on/off only by waving a hand in front of the lamp.



It is supplied with stepless dimmer function for adjustable light output and a battery indicator. The design is ergonomic and lightweight for a perfect, comfortable fit, and the woven band is strong and adjustable. Dust and waterproof (IP65). As optional accessory, the SCANGRIP POWERBANK 03.5782 can be used for increased operating time.



Reading mode setting
Step 1
3-STEP FUNCTION

ZONE 2
€ 39.90
03.5850

NEW
Upgraded
version



EU DESIGN
PATENT

// Rechargeable ZONE 2 headlamp

The new ZONE 2 headlamp provides optimum work light illuminating the entire field of view. It is now delivering even more value for money for the professional user. The light output was increased by 33 % from 150 to 200 lumen, and with improved battery technology and now three light settings, including the new »reading mode«, the maximum operating time was increased to 22 hours. The design has become more compact, modern and user-friendly, and the new ZONE 2 also features a battery indicator and upgraded IP rating to IP54.



Bracket for I-VIEW mounting

NEW



**I-VIEW
HARD HAT BRACKET**
€ 14.90

03.5797



The bracket fits 03.5626 I-VIEW headlamp, as well as 03.5438 NIGHT VIEW.



// Extend the operating time

SCANGRIP POWERBANK is specially developed for I-VIEW as an optional accessory which extends the total operating time to 5.5 hours at full power. See page: 48.

**I-VIEW and
ZONE 2 HEADLAMPS**



**STANDARD
HEADLAMP**



HEADLAMPS

// Compact headlamps designed for work

In almost every working situation it is convenient to have both hands free to carry out your work as efficiently as possible. The HEAD LITEs are developed to provide you with such in-dispensable and supportive bright work light.

Compared to the first generation of headlamps, the HEAD LITEs have been upgraded with the highly efficient COB LED technology that ensures optimal illumination of the work area throughout the day.

- Choose between Alkaline and rechargeable model
- Sensor function with touchless on/off switch
- Waterproof (IP54) to resist workshop environment
- High wear comfort with adjustable elastic headband



// High efficient COB LED headlamp

HEAD LITE S is a compact headlamp designed for the professional user who wants a basic headlamp that is easy to operate and applicable for all kinds of working tasks. It is supplied with a stepless dimmer function, and the lamp head is easily adjusted to obtain the optimum work lighting angle.



HEAD LITE S

€ 14.90

03.5645

Headlamp with stepless dimmer providing up to 140 lumen

Excl. batteries

3
years
warranty





// Advanced headlamp with 2-in-1 light function

The rechargeable HEAD LITE is designed to provide optimum work light illumination with 2 different lighting functions in one: a floodlight beam angle illuminating your entire work area and a focused beam angle for inspection or long-distance use.

HEAD LITE

€ 32.90

03.5669

Rechargeable headlamp with sensor function and stepless dimmer providing up to 150 lumen



// Comfortable headlamp with batteries

HEAD LITE A is compact designed and comfortable to wear with a soft built-in protection pad to avoid imprint on the forehead. Actually, after only few minutes you will stop noticing you wear it. In spite of the small size, the light output has been improved and optimized for maximum performance, enabling the HEAD LITE A to illuminate your entire work area very efficiently. HEAD LITE A is easy to operate and applicable for all kinds of working tasks.

HEAD LITE A

€ 21.90

03.5670

Headlamp with sensor function and stepless dimmer providing up to 150 lumen

// Stepless dimmable



HEAD LITE and HEAD LITE A are upgraded with a stepless dimmer function in the range of 10 % to 100 % that enables you to easily adjust the light output to the work task.

// Touchless sensor



Both headlamps have touchless sensor function making it easy to switch on/off the lamp by just waving in front of the headlamp. In this way you can activate the lamp with thick gloves, and avoid touching the switch button with dirty hands. To avoid unintentional activation you have to activate the sensor with a dual movement.



// Flexible lighting position



The lamp head is easily adjusted to obtain the optimum work lighting angle.

NIGHT VIEW – *for work in the dark*

// New headlamp that keeps your night vision

- Designed for work in the dark
- Rechargeable with touchless sensor function
- Illuminates your entire work space
- Durable, sturdy and waterproof
- Switch between normal white light and red light



3
years
warranty

PATENT PROTECTED

// Choose between white and red work light

The red light is intended for work in the dark and provides light without overexposing the retinas while at the same time keeping the eyes adjusted to the dark.

The red-light functionality is mostly known from the military to read maps on maneuvers at night, but is also needed in civilian professions for work at night, for instance on ships and offshore. On ships it is particularly useful on the bridge at night, because it preserves your night vision so you can work at the control panel. Headlamps with red-light mode are also well suited for security guards that work at night in dark surroundings.

// Newest lighting technology

The NIGHT VIEW provides extremely powerful illumination which spreads the uniform light to the maximum and lightens up your entire field of view. You avoid turning the head to illuminate your actual workspace from a limited headlamp beam.

NIGHT VIEW is provided with the very newest rechargeable battery technology with extraordinary long duration, and sets new standards for professional work light. When set on sensor mode NIGHT VIEW is turned on/off only by waving a hand in front of the lamp. Thus, the light can easily be switched on/off, even when wearing thick gloves.



Keep your night vision

STANDARD HEADLAMP



NIGHT VIEW HEADLAMP



NIGHT VIEW

€ 84.90

03.5438

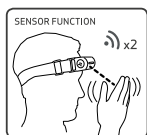

6000 K



632 nm

EU DESIGN PATENT
2635946



STAR – work light and floodlight in one

// STAR is the missing link between a work light and a floodlight. It is a new multifunction work light that does it all!

- Extremely powerful illumination, up to 1000 lumen
- Rechargeable up to 5 h operation time
- Waterproof IP65
- Ergonomic design for a comfortable, firm hand grip
- Flexible handle for multifunctional positioning and application
- Sturdy handle with built-in magnet
- Direct mounting on the SCANGRIP TRIPOD
- Durable housing made of shock-resistant plastic material
- Built-in powerbank



ORIGINAL
SCANGRIP



SINCE 1906

3
years
warranty

PATENT PROTECTED

// Multifunctional work light

STAR is designed to be the work light that does it all. The lamp is ergonomically designed to be used as a hand held work light. Extending the position of the handle, the lamp transforms itself to be a searchlight.

// Handy floodlight

Due to the extremely powerful light output, STAR is also applicable for illumination of a larger working area, in spite of its small size compared to other floodlights. The handle is designed for direct mounting on the SCANGRIP TRIPOD.

// Flexible positioning

Due to the flexible handle the STAR can stand in different positions to obtain the optimal lighting angle for a specific work task. The handle is also clickable in fixed position to serve as a hook for suspension. Using the powerful built-in magnet in the handle the STAR can be placed in flexible positions on any metalized surface.



EU DESIGN
PATENT
3451038



// Powerbank

Built-in power bank with USB outlet to charge mobile devices.



Flexible positioning



STAR
€ 99.90
03.5620



Position the light directly on the SCANGRIP TRIPOD up to 3 m

Handheld work light



NOVA range – world's best work lights for the professional user

// SCANGRIPs range of NOVA work lights are the best, most powerful and sturdy COB LED work lights on the market at all. Made to last and do the job again and again. Even coming with an extended 3-year warranty like all our WORK LIGHTS for high performance.

- Most sturdy and durable work lights made for ROUGH SERVICE USE
- Extremely powerful illumination, up to 12.000 lumen
- Light dimmable in 5 steps
- Waterproof (IP67) for all kinds of outdoor weather conditions
- Stands and suspensions for flexible lighting positioning



3
years
warranty

PATENT PROTECTED

// NOVA work lights for every working situation

The NOVA range provides the widest range of durable work lights in the world. So, you just choose your favourite NOVA model between the various models. And choose if your NOVA should be portable, rechargeable, with exchangeable batteries or with cable.

// Extreme durability

All NOVAs are made of die casted aluminium which makes them extremely sturdy and shockproof. Also, the NOVAs are designed to endure the rough, wet and dirty conditions of the professional working environment, and withstand even outdoor work in all kinds of weather conditions, as they are completely waterproof (IP67).

// Designed for efficient workshop use

The COB (chip on board) LED provides a uniform and completely even illumination with colour temperature close to daylight which is particularly effective as work lighting. The light dimmer function makes it possible to adjust the light into different levels.

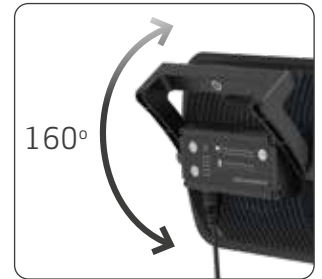

Flexible stand



Slim design

// Various NOVA models

Rechargeable and portable



1000 / 2000 lumen

Rechargeable with DUAL SYSTEM



4000 / 6000 lumen

With cable



4000 / 6000 / 12.000 lumen

DUAL 2 in 1 SYSTEM

Durable work lights designed for ROUGH SERVICE USE

NOVA MINI – extremely compact handheld work light

// With its extremely compact and unique design, the NOVA MINI is a brand-new hand held floodlight that is the ultimate “must-have” for professionals in all industries.



- Ultra-slim and compact design
- Extremely powerful illumination, up to 1000 lumen
- SMART GRIP 4-in-1 system for a comfortable, firm hand grip and flexible positioning
- Stepless dimmer function
- Charging indicator



3
years
warranty

PATENT PROTECTED

ORIGINAL
SCANGRIP



SINCE 1906



// Small-sized with super powerful illumination

Featuring the latest LED technology, NOVA MINI is incredibly powerful and provides up to 1000 lumen – which is absolutely unique for such a small lamp. NOVA MINI is supplied with a practical on/off button on the side that is also acting as a light control. Adjust the light output with the stepless dimmer function in the range of 10 % to 100 %.

As part of the popular NOVA family, NOVA MINI is based on all the same unique and well-known features that the NOVA series is known for. With its compact dimensions, it is more than twenty times smaller than the NOVA 12K and fits perfectly into your pocket.

// SMART GRIP 4-in-1 system

The lamp is supplied with a special, patented SMART GRIP 4-in-1 system that integrates several multi-functions in the same unit. The ring is based on the functionality you know from e.g. mobile phones which makes it easier and more convenient to keep the lamp in your hand for a long time. It relieves the muscles and increases ergonomics.

The clip is designed to fit the work belt and carry the lamp the entire day, and when both hands are needed for a task, the strong built-in magnet can be used for flexible positioning. Furthermore, SMART GRIP can be used as a stand on any available surface.

pat. pend.
SMART GRIP 4 in 1



NOVA MINI

€ 74.90

03.6010



A charge indicator on the side of the lamp keeps you informed about the battery level.

NOVA R handlamp – portable, rechargeable work light

// The handheld NOVA R work light provides powerful illumination and long operating time – perfect to carry around from job to job.

- Rechargeable COB LED work light, up to 2000 lumen
- Ultra-slim and compact design
- Light dimmable in 5 steps
- Flexible positioning
- Built-in powerbank

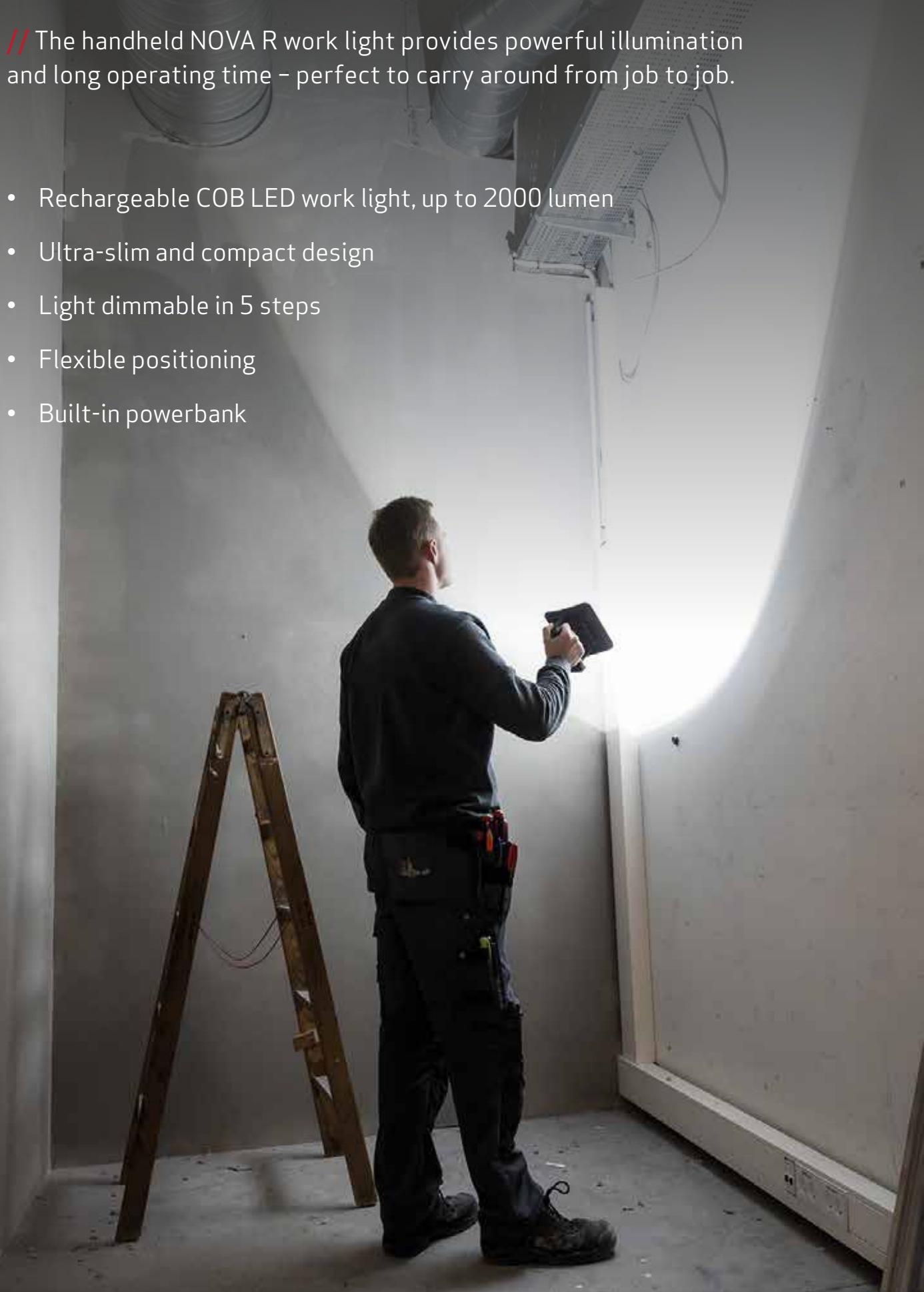

ORIGINAL
SCANGRIP



SINCE 1906

3
years
warranty

PATENT PROTECTED



EU DESIGN
PATENT
4070035

// Portable and universal work light

The NOVA R handlamp is a universal all-around work light designed for the professional user. Featuring the latest high-performance COB LED technology, NOVA R is providing up to 2000 lumen with uniform and even illumination. The light dimmer function makes it possible to adjust the light to five different levels.

The durable construction approves the NOVA R handlamp to ROUGH SERVICE USE which makes it perfect for the demanding, rough working environment.



As an extra feature, NOVA R has also a built-in power bank with USB outlet to charge mobile devices.



Light dimmable in 5 steps

// Multifunctional design for high flexibility

NOVA R is easy to carry and is ergonomically designed for a good grip on the handle, which is also equipped with powerful integrated magnets for flexible mounting. Due to the flexible handle, NOVA R can be placed in different positions to obtain the desired lighting angle. The handle is also designed for direct mounting on the TRIPOD or the SCAFFOLDING BRACKET.



NOVA R
€ 104.90
03.5456



NOVA – the world’s most durable work lights

// The original NOVA work lights are the best, most powerful and sturdy COB LED work lights on the market at all. These are universal work lights for the most challenging lighting operations in every rough and demanding working environment.

- Rechargeable versions with advanced DUAL SYSTEM
- Display for battery capacity and remaining operating time
- Integrated carrying handle
- BLUETOOTH light control app for NOVA 12K



3
years
warranty

PATENT PROTECTED

// Designed for efficient workshop use



The light dimmer function makes it possible to adjust the light into five different levels. With the integrated carrying handle, it is convenient to hand carry the lamp. The flexible stand can be used as a hanger and to position the lamp in the desired lighting angle. The stand is designed for direct mounting on the SCANGRIP TRIPOD.

EU DESIGN
PATENT
2954123



// Rechargeable NOVA's

The NOVA's with the unique DUAL SYSTEM are both rechargeable and with cable providing you unlimited application possibilities. The DUAL SYSTEM connection is improved for easier and faster mounting and disconnecting the cable. The rechargeable versions are also supplied with a user-friendly display showing both battery capacity and the remaining operating time.



NOVA 4K C+R

€ 209.90

03.5441

Work light with DUAL SYSTEM providing up to 4000 lumen

DUAL 2 in 1 SYSTEM



NOVA 6K C+R

€ 249.90

03.5443

Work light with DUAL SYSTEM providing up to 6000 lumen

DUAL 2 in 1 SYSTEM



// NOVA's with cable

The NOVA range offers 3 cable models, all providing extremely powerful illumination. With a light output of up to 12.000 lumen, NOVA 12K is designed for the most challenging lighting operations.

With the integrated BLUETOOTH light control feature you can easily control up to four work lights. The light control also makes it possible to turn on/off the lamp and adjust the light output to suit the work task in question. The BLUETOOTH application is perfect when working with one or more hard-to-reach lamps, for example positioned on the SCANGRIP TRIPOD.



LIGHT CONTROL



Bluetooth®



NOVA 4K

€ 134.90

03.5440

Work light with 5 m cable providing up to 4000 lumen



NOVA 6K

€ 154.90

03.5442

Work light with 5 m cable providing up to 6000 lumen



NOVA 12K

€ 279.90

03.5444



Work light with BLUETOOTH and 5 m cable providing up to 12.000 lumen

VEGA LITE - a range of LED floodlights

ORIGINAL
SCANGRIP
SINCE 1906

// Innovative, high performance work lights

The VEGA LITE range consists of 4 high quality floodlights in cool design offering very powerful illumination at an attractive price.

- Powerful, diffused, non-blinding illumination
- Durable housing made of highly shock-resistant plastic material
- Rechargeable and cabled versions available
- For indoor as well as outdoor use
- No fire hazard due to minimum heat production

// Floodlight with 3 colour temperature settings

VEGA LITE COLOUR is developed especially for house painters and other professional craftsmen working on surface preparation, such as filling, wallpapering, and sanding.

It provides 5000 lumen and features 3 different colour temperature settings including warm (2500 Kelvin), medium (4500 Kelvin), and cold light (6500 Kelvin). Select exactly the colour temperature that suits the work situation best. This functionality is also useful for other indoor tasks, like setting up tiles, ceilings, floors, etc. in the construction industry.

NEW



VEGA LITE COLOUR

€ 179.90

03.5459

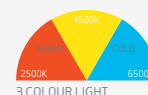

Floodlight with 3 colour temperature settings providing 5000 lumen. With 2 power outlets

2 power outlets



3
years
warranty

PATENT PROTECTED

// Powerful, diffused LED light

The many powerful LEDs of the VEGA LITE floodlights provide a diffused and pleasant, non-blinding, uniform work light, with a large dispersion. The entire range has been upgraded and now provides even more lumen than the previous versions.

// Designed for professionals

The lightweight, sturdy and durable housing of the VEGA LITEs is made of a highly shock-resistant plastic material, constructed for use in the demanding working environment. Contrary to traditional halogen work lights heat production is minimal avoiding fire hazard. The stand is made of powder coated steel and can be mounted directly on the SCANGRIP TRIPOD.

// Unique functionality

The VEGA LITE C+R is with the unique DUAL SYSTEM which means **both** rechargeable **and** with 5 m cable providing complete flexibility and unlimited application possibilities.

// Power outlet

Both the new VEGA LITE COMPACT, VEGA LITE and VEGA LITE COLOUR floodlights are born with power outlet which offers additional functionality in daily use as more lamps can be connected in a string. Also, the outlet can be used as power source for tools and machinery.

DUAL 2 in 1 SYSTEM



EU DESIGN
PATENT
2954123



VEGA LITE provides 6000 lumen and is designed for "rough-service-use" with 2 power outlets on the back

DUAL 2 in 1 SYSTEM



VEGA LITE C+R

€129.90

03.5451

Floodlight with DUAL SYSTEM providing up to 2500 lumen

VEGA LITE COMPACT

€129.90

03.5673

Floodlight with 3 m cable and 1 power outlet providing 4000 lumen

VEGA LITE

€149.90

03.5453

Floodlight with 5 m cable and 2 power outlets providing 6000 lumen

AREA LITE CO

// 360° high performance LED work light

- A must-have universal light for any working site
- Illuminates the entire room and working area
- Powerful, diffused, non-blinding illumination
- Durable housing made of highly shock-resistant plastic material

ORIGINAL
SCANGRIP
SINCE 1906



3
years
warranty

PATENT PROTECTED

// Illuminating the entire working area

The AREA LITE CO is a real basic work light especially designed to illuminate the entire room 360° around. The AREA LITE CO provides a diffused and pleasant, non-blinding, and uniform work light with large dispersion. These features are ideal for the demanding craftsman who requires powerful and efficient illumination of not only larger surfaces but the entire room carrying out any kind of repair, paint or construction work.

// Powerful 360° work light

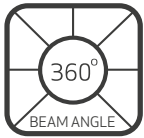

The light output of the upgraded AREA LITE CO has been increased from 4000 lumen to 6000 lumen which is very powerful compared to similar lamps on the market. AREA LITE CO is extremely sturdy and durable and withstands being dropped.

// Flexible positioning

The AREA LITE CO can be positioned directly on the workbench or hang in the sturdy hook from any mounting option available. SCANGRIP mounting stands offer completely flexible lighting solutions; the lamp can be mounted directly onto the TRIPOD without any time spent on fastening obtaining a height of up to 3 m. If you need a mobile light that can be moved quickly from place to place the lamp can be mounted directly on the WHEEL STAND.



EU DESIGN
PATENT
4070035

Strong built-in nylon strap with hook for suspension. The strap is also designed as a practical carrying strap



AREA LITE CO

€ 159.90

03.5637

360° work light with 5 m cable and power outlet providing 6000 lumen



More lamps can be connected in a string by the power outlet of the AREA LITE CO and can also be used as power source for various tools and machinery.



STANDS and SUSPENSIONS

// Designed for direct mounting of work lights without bracket. Made of durable and sturdy powder coated steel for both indoor and outdoor use.

// High stability tripod

The SCANGRIP TRIPOD is indispensable for stationary positioning of the work light for illumination in a specific working area. The SCANGRIP TRIPOD is extendable from only 1.35 m up to 3 m which gives you complete flexibility to position the light in the requested height.

The stable construction of the SCANGRIP TRIPOD 3M makes it safe even when fully extended. It is supplied with anchor points that provide an opportunity for extra stability if the tripod is exposed to strong wind or standing on an uneven surface. To increase safety when in use, the cable of the lamp can be fixed in the safety clips placed on each separate leg.

// Lightweight TRIPOD with QUICK RELEASE function



With its lightweight and extremely handy design, the SCANGRIP TRIPOD 2M is indispensable for stationary positioning of the work light for illumination in a specific working area. The tripod is extendable from 0.9 meter up to 2 meters, which gives you complete flexibility to position the light in the requested height. When mounted on the tripod the light can be tilted to provide the optimum beam angle.

Featuring a compact design and QUICK RELEASE function, it is easy and convenient to carry the tripod and set it up where illumination is needed. The tripod is extremely durable and can be applied for both indoor and outdoor use. The stable construction makes it safe even when fully extended. It is made of black painted aluminum.

QUICK RELEASE function



Welded steel mounting cap 10 mm thread

SCANGRIP TRIPOD 3M

€ 119.90

03.5431

6 kg
Max load 10 kg

360° locking system for a firm grip

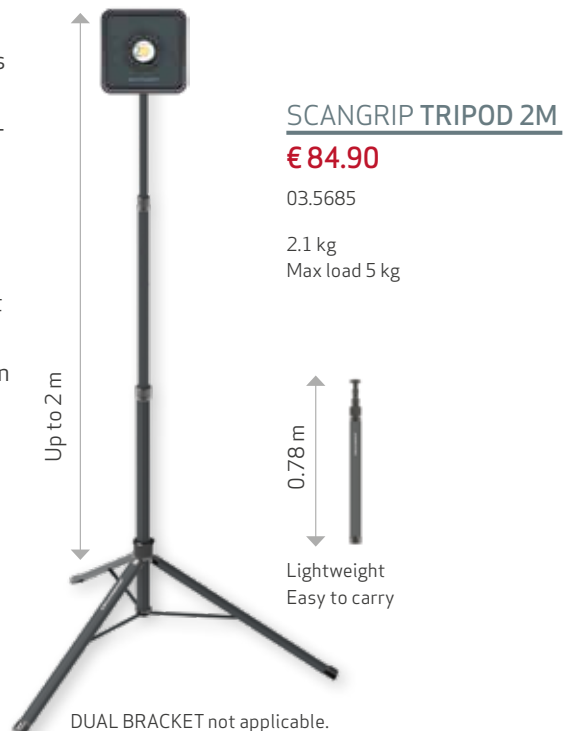

SCANGRIP TRIPOD 2M

€ 84.90

03.5685

2.1 kg
Max load 5 kg

0.78 m
Lightweight
Easy to carry

DUAL BRACKET not applicable.

// Wheel stand for mobile positioning

The SCANGRIP WHEEL STAND makes it easy to move the light to where you need it, and at the same time you avoid uncomfortable and heavy lifting from one workplace to the other. It is upgraded with a new base which is equipped with 5 wheels for improved safety and stability and easy maneuverability.



As an additional feature, it now comes with a flexible bracket that enables you to easily position a second work light to illuminate from below. The extra mounting bracket is adjustable in the height and provides complete flexibility to position the light in the optimum height.



WHEEL STAND

€ 159.90

03.5682

6.6 kg
Max load 10 kg

// Suspensions for flexible positioning

DUAL BRACKET

€ 26.90

03.5308



Dual bracket for positioning of two lamps on TRIPOD or WHEEL STAND

SCAFFOLDING BRACKET

€ 31.90

03.5341



For flexible positioning on scaffolding or any round object ø40-50 mm



MAGNET BRACKET

€ 31.90

03.5390



For flexible positioning of the work light on any magnetic surface

MAGNET BRACKET - Large

€ 54.90

03.5391



// SCANGRIP DIFFUSER provides a large dispersion and spreads the light

Enlightens the entire working area, even into the darkest corner and softens the light avoiding hard shadows. Minimizes reflections and harsh light and provides non-blinding work light.



Easy and safe mounting with strong magnets

SCANGRIP DIFFUSER

€ 10.90

03.5750

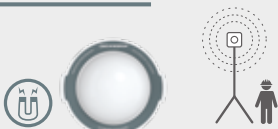

SCANGRIP DIFFUSER - Large

€ 15.90

03.5751



NEW

SCANGRIP DIFFUSER - Medium

€ 8.90

03.5922



SITE LIGHT – high-performance construction site lights

// SCANGRIP presents new, powerful SITE LIGHT work lights that are made in Denmark and provide extremely high light output at a very attractive price.

The SITE LIGHTs feature active cooling and have a long lifetime. Available in two variants providing 40.000 lumen and 80.000 lumen.

- Powerful illumination with wide beam angle
- Light dimmable in 4 steps
- BLUETOOTH light control
- Compact and low weight
- Waterproof (IP65) for all kinds of outdoor weather conditions



SITE LIGHT 80

€ 1069.90

03.5269

 Large area light with BLUETOOTH and dimmer function providing up to 80.000 lumen

SITE LIGHT 40

€ 669.90

03.5268

 Large area light with BLUETOOTH and dimmer function providing up to 40.000 lumen

3
years
warranty

PATENT PROTECTED

ORIGINAL
SCANGRIP



SINCE 1906

MADE IN DENMARK



EU DESIGN
PATENT
7180187

Bluetooth®

BLUETOOTH - Light control app

- Dimmer light output into 4 levels
- Switch on/off
- Group control function, up to 4 lamps
- Assign pin code



Compliant with iPhone 5 or higher / Android 5.0 or higher. Go to iTunes App Store to download the app or download the app from scangrip.com

// Powerful illumination and BLUETOOTH light control

Based on the newest state-of-the-art LED technology, the SITE LIGHTs provide an extremely high light output and a wide 120° beam angle, ensuring super bright illumination of a large work area. The dimmer function enables you to adjust the light in four different levels, and by using the BLUETOOTH light control app, you can turn on/off the work light and adjust the light remotely through your mobile device. When the work lights are mounted on high masts, this feature reduces the power consumption on an everyday basis as you only use the amount of light necessary to do the job.

// Compact design for easy mounting



The SITE LIGHTs are designed with a built-in handle for easy carrying and mounting on tripod and masts. They are extremely compact and low weight compared to other solutions on the market, which makes the mounting of the work lights more convenient. The SITE LIGHTs come with

10-meter cable and include a DIN14640 connection adapter with bracket for mounting on a tripod.

// Built to do the job at the construction site

The SITE LIGHTs are completely dust and waterproof (IP65) and tolerate all kinds of weather conditions from -25 to +40 °C. Featuring high-quality components and active cooling, the work lights have a long lifetime and keep a high performance level throughout the day.



**TRANSPORT CASE
SITE LIGHT 80**

€ 171.90

49.0351

**TRANSPORT CASE
SITE LIGHT 40**

€ 96.90

49.0350

The transport cases enable you to safely transport your SITE LIGHT work light to the building site. They are sturdy and high-quality cases that can withstand shocks and rough handling during transport.

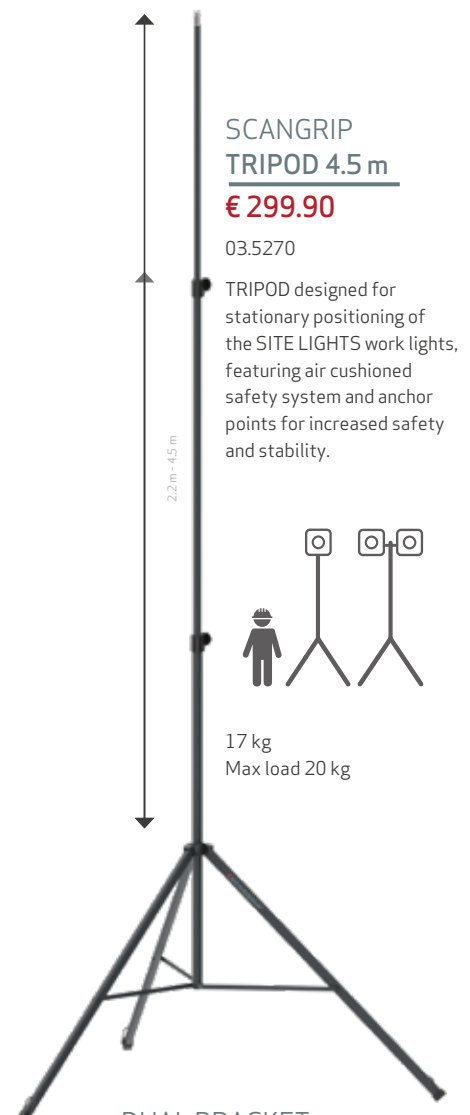

**SCANGRIP
TRIPOD 4.5 m**

€ 299.90

03.5270

TRIPOD designed for stationary positioning of the SITE LIGHTs work lights, featuring air cushioned safety system and anchor points for increased safety and stability.

17 kg
Max load 20 kg

**DUAL BRACKET
SITE LIGHT**

€ 53.90

03.5758



Dual bracket for positioning of two SITE LIGHTs

ROPE LIGHT - 25 m flexible rope light providing 20.000 lumen



// Illuminate your surroundings and stay safe on the worksite with a practical and legal rope light.

- EMC certified rope light with built-in power supply
- Maximum safety with low voltage (48 V DC)
- No risk of electrical shock
- Made of durable and heat-resistant silicone

3
years
warranty

PATENT PROTECTED



// Maximum safety

ROPE LIGHT runs on low voltage (48 V DC), which means that there is no risk of electrical shock if the rope should be accidentally pinched or cut. This distinguishes ROPE LIGHT from all other rope lights on the market, which use 230 V power directly connected with the risk of fatal shocks. Only light ropes operated through a power supply are legal. ROPE LIGHT is made of heat resistant silicone and fully flexible, even in extreme cold down to -20 °C. With IP65, the rope light is suitable for use in humid working environments.

ROPE LIGHT is flicker-free, which means that there is no annoying flicker effect that can be a nuisance during the work and, in the worst case, cause misjudgment of rotating tools. ROPE LIGHT is EMC certified and in compliance with all applicable legislation in the area (EMC directive 2014/30/EU).

// Easy and convenient connection

ROPE LIGHT is delivered on an impact-resistant drum with a practical carrying handle. The power supply is built-in with a fixed 1.5 m connection cable, making it easy to connect to a standard power socket. To avoid overheating, always unwind the light rope completely from the drum before connecting the power. For convenient storage, the power cable can be wrapped around the drum under the light rope when not in use.



Durable silicone bendable down to -20 °C and passed 650 °C glow-wire testing



High IP for use in moist environment



Flicker free



ROPE LIGHT

€ 399.90

03.5815

25 m flexible rope light providing 20.000 lumen



Built-in power supply with over-temperature protection and 1.5 m cable



FLEX WEAR – flexible work light designed to wear

// Indispensable little companion you can take with you everywhere

FLEX WEAR is a small wearable flexible work light designed with a 2-step main light providing as much as 150 lumen and a spotlight providing 75 lumen. It increases safety and working comfort making you visible moving around and providing light to illuminate your workspace. It can also be used as a pocket light with the built-in clip, as an inspection light or positioned fixed with the built-in magnet. The design of FLEX WEAR is smooth, compact and lightweight, only 42 g.



NEW

FLEX WEAR

€ 30.90

03.5810



Use as flashlight



Built-in magnet



Clip onto your clothes

// FLEX WEAR including headband and cap mount

With the accessories included in the FLEX WEAR KIT it can be used as a headlamp or mounted on a cap. Use the spotlight for a long-distance light wearing it on the side of your head. Fixed on the headband or cap mount FLEX WEAR provides total flexibility to obtain the best possible lighting angle since it can be turned 360° around both axes.

- Clip onto your cap
- Use as a headlamp
- Clip onto your clothes
- Use as a flashlight

NEW

FLEX WEAR KIT

€ 41.90

03.5811

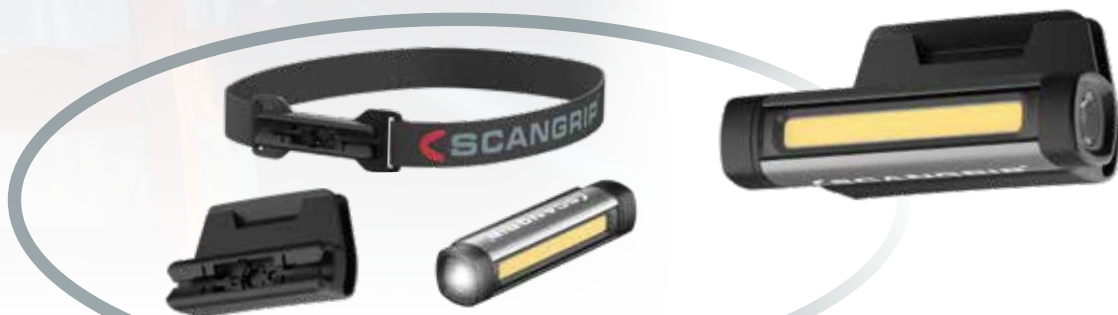

FLEX WEAR is 100 % flexible work light with numerous areas of application. Use it exactly where you want: in your chest or pant pocket with the built-in clip, on your cap with the special mounting device or use it as headlamp mounted on the headband. FLEX WEAR can also be used as a flashlight for inspection or positioned and fixed with the built-in magnet to illuminate your work area.

ORIGINAL
SCANGRIP



SINCE 1906

3
years
warranty

PATENT PROTECTED

FLASHLIGHT *series*

// SCANGRIP provides the strongest and most comprehensive range of LED work lights on the market. We are now proud to present an upgraded and re-designed flashlight series providing extremely high light output and improved functionality for an even better user experience.

The new flashlights are available both as rechargeable and with batteries, providing brand-new features and accessories to increase work efficiency.

- BOOST MODE
- Practical clip-on holster for the work belt
- One-hand operated magnetic switch
- Higher lumen output
- Long operation time



FLASH series with batteries

// The new durable flashlight series with Alkaline batteries is designed for the rough and demanding work environment providing high-quality flashlights for all types of inspection tasks.

EU DESIGN
PATENT
7180187

Dimmable keychain light with integrated USB charger cable

Ultra-compact and bright LED keychain light that provides up to 75 lumen.

FLASH MICRO R

€ 14.90

03.5113



FLASH MICRO R comes in a display of 12 pcs.



Powerbank with battery indicator

Designed for the I-VIEW headlamp but can be used for recharging any SCANGRIP work light as well as other devices. Featuring battery indicator and intelligent load detection. Modern and durable design.

SCANGRIP POWERBANK

€ 29.90

03.5782

4000 mAh aluminum powerbank

The new ultra-slim FLASH PENCIL

A must-have for everybody doing daily inspection tasks. It is so thin, only ø15 mm. Supplied with a clip and designed to always have in the chest pocket, right at your fingertips.

Weighing only 32 g the FLASH PENCIL is incredibly lightweight.

FLASH PENCIL

€ 19.90

03.5130

Ultra-slim pencil flashlight providing 75 lumen



FLASH PEN

€ 27.90

03.5131

Pencil flashlight with boost mode providing up to 200 lumen

FLASH 300

€ 34.90

03.5132

Flashlight with boost mode providing up to 300 lumen
Incl. silicone wrist strap and clip-on holster

FLASH 600

€ 44.90

03.5133

Flashlight with boost mode providing up to 600 lumen
Incl. silicone wrist strap and clip-on holster

3
years
warranty

Rechargeable FLASH R series

// Sturdy and powerful flashlights of extraordinary high quality providing extremely bright illumination and durability. Easily recharged by the enclosed USB cable.

The new WORK PEN 200 R is a real work light for professional inspection work. It is extremely powerful for its small size. Supplied with a clip for the chest pocket and built-in magnets for flexible positioning.

EU DESIGN
PATENT
7180187



MINI LITE A

€ 8.90

03.5102

Small pocket-sized flashlight with keychain providing 100 lumen



Pocket sized FLASH 12-24V

With a new brushed-up look, the FLASH 12-24V is designed to easily charging directly from the cigarette lighter socket in your car. No need of charger device, cable, or batteries!

FLASH 12-24V

€ 29.90

03.5124

Rechargeable flashlight providing 130 lumen

FLASH 1000 R

€ 69.90

03.5138

Rechargeable flashlight with boost mode providing up to 1.000 lumen
Incl. silicone wrist strap and clip-on holster

FLASH 600 R

€ 59.90

03.5137

Rechargeable flashlight with boost mode providing up to 600 lumen
Incl. silicone wrist strap and clip-on holster

FLASH PEN R

€ 39.90

03.5136

Rechargeable pencil flashlight with boost mode providing up to 300 lumen

WORK PEN 200 R

€ 29.90

03.5127

Rechargeable LED penlight providing up to 200 lumen



LINE LIGHT – *unique lighting concept*

// LINE LIGHT is a flexible lighting solution for universal application designed for use anywhere where strong, efficient and concentrated light in a specific working area is needed. Now in a new upgraded version with double lumen output.

- Most competitive solution on the market
- “Unbreakable” - extremely sturdy and shockproof
- Waterproof to resist wet and dirty workshop environment
- Low voltage 24 VDC
- Technical lifetime of LEDs 100.000 hours
- Made in Denmark



ORIGINAL
SCANGRIP



SINCE 1906

MADE IN DENMARK

3
years
warranty

PATENT PROTECTED

// Bright illumination exactly where you need it

By means of a built-in prism, LINE LIGHT concentrates the light in a 75° beam angle providing an extremely bright and powerful illumination of the specific working area. Blinding during work is avoided, and the lamp itself can be turned to provide the optimum lighting angle.

// Innovative LED technology

The LINE LIGHT series is based on the newest state-of-the-art LED technology and provides much more light compared to the traditional 36 W fluorescent tubes which are commonly used within the industry.

The quality of the light is extremely powerful, like daylight which is optimum for precise recognition of colours, shades and other product details. The uniform, flicker free illumination without strobe effects also minimizes the risk of accidents.

// Extreme durability

LINE LIGHT is constructed by a closed "unbreakable" extruded acrylic profile which makes it extremely sturdy and shockproof to endure even strong strokes, shocks and vibrations from industrial machinery.

LINE LIGHT endures the rough, wet and dirty conditions of the professional working environment within the industry and is resistant to both oil and chemicals. The IP67 classification means that it is resistant to both dust and water. LINE LIGHT is completely maintenance free.

// Reduced power consumption

Compared to traditional fluorescent tube lighting, the electricity consumption is considerably reduced when using LINE LIGHT which presents serious cost savings on electricity.



// Dimmer

With the dimmer function it is possible to adjust the light intensity stepless from 1-100 % to meet individual working conditions. LINE LIGHT 2-POST and LINE LIGHT 4 are delivered incl. dimmer, and can also be bought separately and retrofitted on all existing LINE LIGHT installations.

BEAM
ANGLE
75°



IP67



EU DESIGN
PATENT
1882523



ULTRA
SLIM
DESIGN
Ø25 mm

FLEXIBLE lighting solution for 2-post lifts and mobile column lifts

ORIGINAL
SCANGRIP



SINCE 1906

MADE IN DENMARK

LINE LIGHT 2-POST is a universal all-in-one solution always available at hand and ready to use when needed.

The lighting unit can be positioned everywhere underneath the car with magnets and can be moved under the car to the actual repair work.

Due to the 5 m spiral cable, the lamp can easily be used for illumination around the entire car, or as a dedicated lamp for engine bay or wheel arch illumination.

- Fits all 2-post lifts and mobile column lifts regardless of type
- Powerful illumination providing 2 x 1250 lumen
- Easy and uncomplicated to mount
- No drilling in the lift construction
- Incl. DIMMER function

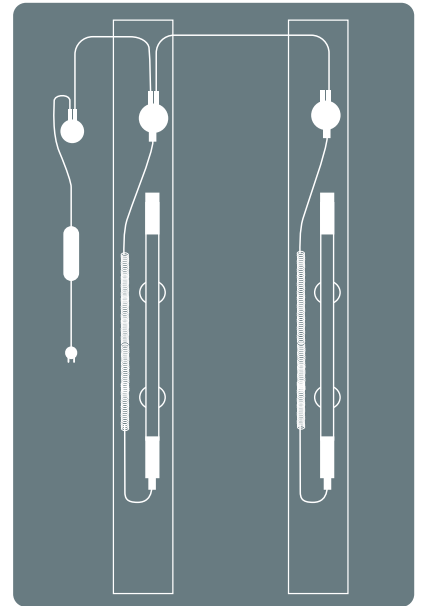

LINE LIGHT 2-POST

€ 403.90

03.5225



FLEXIBLE MAGNETIC SUSPENSION



3
years
warranty

PATENT PROTECTED

COMPLETE lighting solution for automotive lifts

- Extremely powerful illumination of working area - improved lumen output
- Improve work efficiency and working conditions
- Avoid blinding the mechanic during work
- Adjustable lighting angle

// Compact design

Compared to traditional 36 W fluorescent tubes, LINE LIGHT provides an extremely bright and powerful illumination of the entire undercarriage. The slim and compact design leaves space for the center jack to pass.

// Easy DIY installation

As LINE LIGHT is a low operating voltage (24 V DC) system, you can easily do the installation yourself. All basic fittings are supplied with each kit together with power supply and cable. The pre-defined LINE LIGHT kits are considered universal and will fit the majority of all automotive 4-post lifts, regardless of the manufacturer or brand.

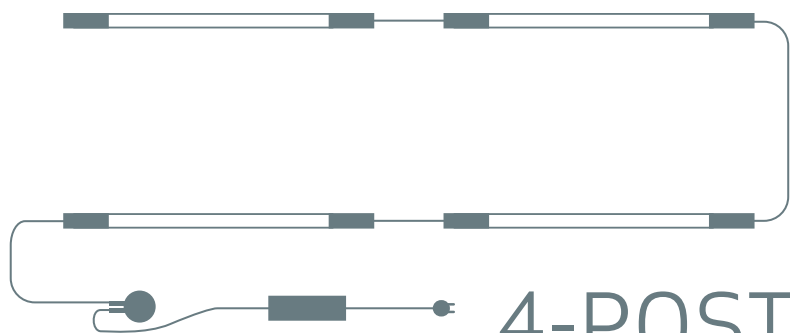

4-POST LIFTS

BEAM ANGLE
75°



Blinding of the mechanic during work is avoided, and the lamp itself can be turned to provide the optimum lighting angle during work.



Example of LINE LIGHT solution mounted in a truck mechanic's pit

LINE LIGHT 1

€ 241.90

03.5203

1 complete lighting unit 1630 mm incl. 25 W power supply, cable and suspension providing 2750 lumen

LINE LIGHT 2

€ 393.90

03.5202

2 complete lighting units 1234 mm each providing 2000 lumen, incl. 80 W power supply, cable and suspension

LINE LIGHT 4

€ 1009.90

03.5201

4 complete lighting unit 1630 mm each providing 2750 lumen, incl. 80 W power supply, cable, suspension and dimmer function

LINE LIGHT 6

€ 1514.90

03.5200

6 complete lighting units 1630 mm each providing 2750 lumen, incl. 2 pcs 80 W power supply, cable and suspension

FLEXIBLE lighting units for customized installations

The LINE LIGHT lighting units are available in different lengths which can either be used alone or connected in a string to fit all kinds of application.

The lighting units can be combined exactly the way you want offering a flexible lighting solution.

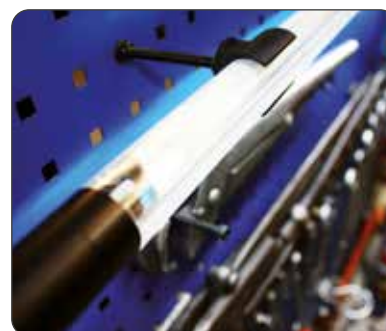
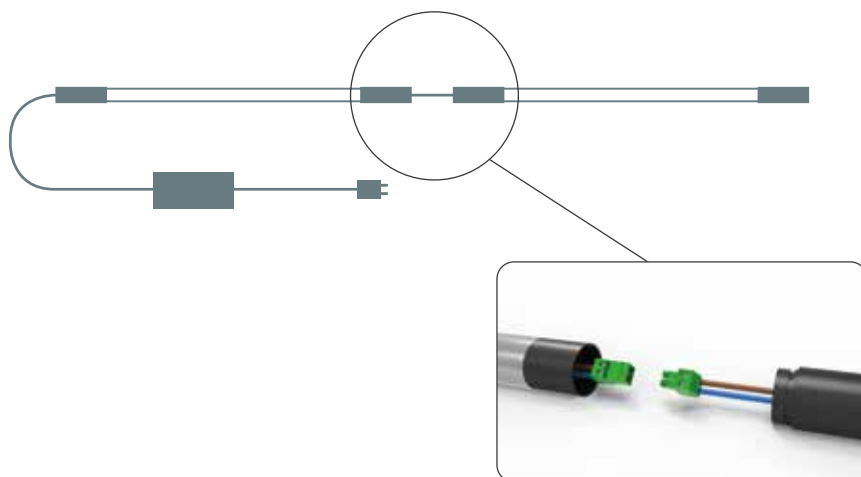

// Flexibility that meets your specific needs

Combine lighting units with power supply, cable and suitable suspensions. A range of flexible suspensions makes it possible to position the lighting units exactly where you need it.

DESIGN YOURSELF

LINE LIGHT 75

€ 120.90

03.5221

Lighting unit 838 mm
providing 1250 lumen

LINE LIGHT 120

€ 201.90

03.5222

Lighting unit 1234 mm
providing 2000 lumen

LINE LIGHT 160

€ 231.90

03.5223

Lighting unit 1630 mm
providing 2750 lumen

LINE LIGHT 200

€ 272.90

03.5224

Lighting unit 2027 mm
providing 3500 lumen

3

years
warranty

PATENT PROTECTED



MAG series

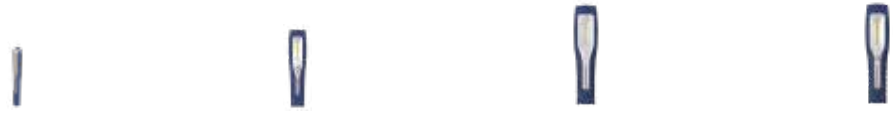

| | MAG PEN 3 | MINI MAG PRO | MAG | MAG PRO |
|-----------------------------------|-----------------------------|---------------------------------|-------------------------------------|---------------------------------|
| Product number | 03.5116 | 03.5692 | 03.5400 | 03.5690 |
| Light source | COB LED Spot: CREE XP-G2 | COB LED Spot: High power LED | 10 SMD LEDs Spot: High power LED | COB LED Spot: High power LED |
| LED performance, lumen/W | 180 | 165 | 118 | 185 |
| Luminous flux, lumen | 15-150 Spot: 80 | 20-200 Spot: 80 | 150-300 Spot: 80 | 60-600 Spot: 150 |
| Adjustable light output | Stepless | Stepless | 2 levels | Stepless |
| CRI | Ra > 80 | Ra > 80 | Ra > 80 | Ra > 80 |
| CCT | 6000 K | 6000 K | 6000 K | 6000 K |
| Operating time with max. lumen, h | 2 | 2 | 2.5 | 1.5 |
| Operating time with min. lumen, h | 20 | 20 | 5 | 15 |
| Charging time, h | 3.5 | 3 | 4 | 4 |
| Battery | 3.7 V / 750 mAh Li-ion | 3.7 V / 1200 mAh Li-ion | 3.7 V / 2200 mAh Li-ion | 3.7 V / 2600 mAh Li-ion |
| Protection class | IP20 | IP54 | IP20 | IP54 |
| Impact protection | IK07 | IK07 | IK07 | IK07 |
| Impact resistance | 1 m | 1 m | 1 m | 1 m |
| Cable | 1 m USB | 1 m USB | 1 m USB | 1 m USB |
| Operating voltage AC | - | - | - | - |
| Charging voltage/current DC | 5 V / 1 A | 5 V / 1 A | 5 V / 1 A | 5 V / 1 A |
| Power consumption | Max 2.5 W | Max 2.5 W | Max 3.5 W | Max 6.5 W |
| Charger incl. | No | No | Country depended | Country depended |
| Temperature | -10 to +40 °C | -10 to +40 °C | -10 to +40 °C | -10 to +40 °C |
| Dimensions | 174 x 31 x 21 mm | 200 x 40 x 28 mm | 260 x 61 x 43 mm | 261 x 62 x 43 mm |
| Net weight | 78 g | 157 g | 252 g | 339 g |
| Price | € 37.90 | € 42.90 | € 52.90 | € 64.90 |

UNIFORM series



| | UNIPEN | MINIFORM | UNIFORM | SUPERFORM | UV-FORM |
|-----------------------------------|---------------------------------|---------------------------------|---------------------------------|---------------------------------|-----------------------------------|
| Product number | 03.5420 | 03.5404 | 03.5407 | 03.5406 | 03.5408 |
| Light source | COB LED Spot: High power LED | COB LED Spot: High power LED | COB LED Spot: High power LED | COB LED | COB LED Spot: High power UV-light |
| LED performance, lumen/W | 125 | 165 | 150 | 130 | 128 |
| Luminous flux, lumen | 75-150 Spot: 75 | 100-200 Spot: 120 | 250-500 Spot: 175 | 750 | 125-250 Spot: UV |
| Adjustable light output | 2 levels | 2 levels | 2 levels | No | 2 levels |
| Beam angle | - | 110° | - | - | - |
| CRI | Ra > 80 | Ra > 80 | Ra > 80 | Ra > 80 | Ra > 80 |
| CCT | 6000 K | 6000 K | 6000 K | 6000 K | 6000 K |
| Operating time with max. lumen, h | 2 | 3 | 2 | - | 2.5 |
| Operating time with min. lumen, h | 4 | 6 | 4.5 | - | 5 |
| Charging time, h | 2.5 | 3 | 5 | - | 3 |
| Battery | 3.7 V / 750 mAh Li-ion | 3.7 V / 1600 mAh Li-ion | 3.6 V / 3000 mAh Li-ion | - | 3.7 V / 1600 mAh Li-ion |
| Protection class | IP65 | IP65 | IP65 | IP54 | IP20 |
| Impact protection | IK07 | IK07 | IK07 | IK08 | IK07 |
| Impact resistance | 1 m | 1 m | 1 m | 1 m | 1 m |
| Cable | 1 m USB | 1 m USB | 1 m USB | 5 m HO5RN-F 2x1 mm ² | 1 m USB |
| Operating voltage AC | - | - | - | 100-240 V | - |
| Charging voltage/current DC | 5 V / 1 A | 5 V / 1 A | 5 V / 1 A | - | 5 V / 1 A |
| Power consumption | Max 1.5 W | Max 2.5 W | Max 6 W | Max 8 W | Max 3 W |
| Charger incl. | No | Country depended | Country depended | - | Country depended |
| Temperature | -10 to +40 °C | -10 to +40 °C | -10 to +40 °C | -10 to +40 °C | -10 to +40 °C |
| Dimensions | 155 x 27 x 21 mm | 122 x 60 x 28 mm | 190 x 60 x 32 mm | 270 x 49 x 31 mm | 155 x 60 x 32 mm |
| Net weight | 80 g | 130 g | 263 g | 710 g | 156 g |
| Price | € 45.90 | € 56.90 | € 89.90 | € 61.90 | € 79.90 |

Optional accessory for
03.5691 MAG PRO WIRELESS

SCANGRIP[®]

INNOVATION FROM DENMARK

MAG PRO WIRELESS



NEW



NEW



| | MAG PRO WIRELESS |
|-----------------------------------|---------------------------------|
| Product number | 03.5691 |
| Light source | COB LED Spot: High power LED |
| LED performance, lumen/W | 185 |
| Luminous flux, lumen | 60-600 Spot: 150 |
| Adjustable light output | Stepless |
| CRI | Ra > 80 |
| CCT | 6000 K |
| Operating time with max. lumen, h | 1.5 |
| Operating time with min. lumen, h | 15 |
| Charging time, h | USB: 4 h - Wireless: 7 h |
| Battery | 3.7 V / 2600 mAh Li-ion |
| Protection class | IP54 |
| Impact protection | IK07 |
| Impact resistance | 1 m |
| Cable | 1 m USB |
| Operating voltage AC | - |
| Charging voltage/current DC | 5 V / 1 A |
| Power consumption | Max 6.5 W |
| Charger incl. | - |
| Temperature | -10 to +40 °C |
| Dimensions | 261 x 62 x 43 mm |
| Net weight | 340 g |
| Price | € 74.90 |

| | CHARGING PAD |
|-----------------------------------|-----------------------|
| Product number | 03.5928 |
| Light source | - |
| LED performance, lumen/W | - |
| Luminous flux, lumen | - |
| Adjustable light output | - |
| CRI | - |
| CCT | - |
| Operating time with max. lumen, h | - |
| Operating time with min. lumen, h | - |
| Charging time, h | - |
| Battery | - |
| Protection class | IP30 |
| Impact protection | IK07 |
| Impact resistance | 1 m |
| Cable | USB (excl.) |
| Operating voltage AC | 100-240 V AC 50/60 Hz |
| Charging voltage/current DC | 5 V / DC 1 A |
| Power consumption | Max 5 W |
| Charger incl. | - |
| Temperature | -10 to +40 °C |
| Dimensions | 183 x 84 x 13 mm |
| Net weight | 115 g |
| Price | € 29.90 |

| | STAR | STARLITE |
|-----------------------------------|-------------------------|-------------------------------------|
| Product number | 03.5620 | 03.5671 |
| Light source | COB LED | COB LED |
| LED performance, lumen/W | 140 | 175 |
| Luminous flux, lumen | 500-1000 | 400 |
| Adjustable light output | 2 levels | - |
| CRI | Ra > 80 | Ra > 80 |
| CCT | 6000 K | 6000 K |
| Operating time with max. lumen, h | 2.5 | - |
| Operating time with min. lumen, h | 5 | - |
| Charging time, h | 8 | - |
| Battery | 3.7 V / 5200 mAh Li-ion | - |
| Protection class | IP65 | IP40 |
| Impact protection | IK07 | IK08 |
| Impact resistance | 1 m | 1 m |
| Cable | 1 m USB | 5 m / 2x1.0 mm ² H05RN-F |
| Operating voltage AC | - | 100-240 V |
| Charging voltage/current DC | 5 V / 1 A | - |
| Power consumption | Max 8.5 W | Max 4.5 W |
| Charger incl. | Country depended | - |
| Temperature | -10 to +40 °C | -10 to +40 °C |
| Dimensions | 156 x 103 x 98 mm | 340 x 40 x 25 mm |
| Net weight | 620 g | 600 g |
| Price | € 99.90 | € 34.90 |

SLIM series



| | MINI SLIM | SLIM |
|-----------------------------------|---------------------------------|---------------------------------|
| Product number | 03.5610 | 03.5612 |
| Light source | COB LED Spot: High power LED | COB LED Spot: High power LED |
| LED performance, lumen/W | 170 | 155 |
| Luminous flux, lumen | 100-200 spot: 100 | 250-500 spot: 100 |
| Adjustable light output | 2 levels | 2 levels |
| Beam angle | - | - |
| CRI | Ra > 80 | Ra > 80 |
| CCT | 6000 K | 6000 K |
| Operating time with max. lumen, h | 2.5 | 2.5 |
| Operating time with min. lumen, h | 5 | 5 |
| Charging time, h | 3 | 4.5 |
| Battery | 3.7 V / 1200 mAh Li-ion | 3.6 V / 3000 mAh Li-ion |
| Protection class | IP30 | IP30 |
| Impact protection | IK07 | IK07 |
| Impact resistance | 1 m | 1 m |
| Cable | 1 m USB | 1 m USB |
| Operating voltage AC | - | - |
| Charging voltage/current DC | 5 V / 1 A | 5 V / 1 A |
| Power consumption | Max 2 W | Max 4 W |
| Charger incl. | Country depended | Country depended |
| Temperature | -10 to +40 °C | -10 to +40 °C |
| Dimensions | 132 x 41 x 30 mm | 165 x 44 x 28 mm |
| Net weight | 101 g | 224 g |
| Price | € 62.90 | € 77.90 |

STICK LITE series



| | STICK LITE S | STICK LITE M |
|-----------------------------------|-------------------------|-------------------------|
| Product number | 03.5665 | 03.5666 |
| Light source | COB LED | COB LED |
| LED performance, lumen/W | 165 | 130 |
| Luminous flux, lumen | 20-200 Spot: 50 | 40-400 Spot: 75 |
| Adjustable light output | Stepless | Stepless |
| Beam angle | 110° / 35° | 110° / 35° |
| CRI | Ra > 80 | Ra > 80 |
| CCT | 6000 K | 6000 K |
| Operating time with max. lumen, h | 2 | 2 |
| Operating time with min. lumen, h | 20 | 20 |
| Charging time, h | 2.5 | 3 |
| Battery | 3.7 V / 1200 mAh Li-ion | 3.7 V / 1800 mAh Li-ion |
| Protection class | IP20 | IP20 |
| Impact protection | IK07 | IK07 |
| Impact resistance | 1 m | 1 m |
| Cable | 1 m USB | 1 m USB |
| Operating voltage AC | - | - |
| Charging voltage/current DC | 5 V / 1 A | 5 V / 1 A |
| Power consumption | Max 2.5 W | Max 4 W |
| Charger incl. | No | No |
| Temperature | -10 to +40 °C | -10 to +40 °C |
| Dimensions | 150 x 34 x 13 mm | 250 x 34 x 15 mm |
| Net weight | 52 g | 88 g |
| Price | € 24.90 | € 34.90 |

LINE LIGHT inspection



| | LINE LIGHT C+R | LINE LIGHT R |
|-----------------------------------|-------------------------------------|--------------------------------|
| Product number | 03.5243 | 03.5244 |
| Light source | 36 SMD LED Spot: CREE XP-G2 | 20 SMD LED Spot: CREE XP-G2 |
| LED performance, lumen/W | 189 | 189 |
| Luminous flux, lumen | 900 Spot: 150 | 600 Spot: 150 |
| Illuminance, lux@0.5 m | 1800 Spot: 1500 | 1200 Spot: 1500 |
| Adjustable light output | No | No |
| Beam angle | 75° Spot: 50° | 75° Spot: 50° |
| CRI | Ra > 80 | Ra > 80 |
| CCT | 6500 K | 6500 K |
| Operating time with max. lumen, h | 2.5 Spot: 8 | 1.5 Spot: 4 |
| Operating time with min. lumen, h | - | - |
| Charging time, h | 4 | 6 |
| Battery | 3.7 V / 5200 mAh Li-ion | 3.7 V / 2600 mAh Li-ion |
| Protection class | IP65 | IP65 |
| Impact protection | IK07 | IK07 |
| Impact resistance | 1 m | 1 m |
| Cable | 5 m / 2 x 1 mm ² H05RN-F | 1 m USB |
| Operating voltage AC | - | - |
| Charging voltage/current DC | 4.2 V / 3.5 A | 5 V / 1 A |
| Power consumption | Max 8 W | Max 5.5 W |
| Charger incl. | Yes | Country depended |
| Temperature | -10 to +40 °C | -10 to +40 °C |
| Dimensions | ø25 x 461 mm | ø25 x 357 mm |
| Net weight | 300 g | 220 g |
| Price | € 104.90 | € 92.90 |

BONNET LIGHTS



| | LINE LIGHT BONNET C+R | NOVA BONNET |
|-----------------------------------|---------------------------------------|-------------------------|
| Product number | 03.5240 | 03.5457 |
| Light source | 64 SMD LED | High efficiency COB LED |
| LED performance, lumen/W | 189 | 160 |
| Luminous flux, lumen | 700-1400 | 200-2000 |
| Illuminance, lux@0.5 m | 1000-2000 | - |
| Adjustable light output | 2 levels | 5 levels |
| Beam angle | 75° | - |
| CRI | Ra > 80 | Ra > 80 |
| CCT | 6500 K | 6000 K |
| Operating time with max. lumen, h | 1.5 | 2 |
| Operating time with min. lumen, h | 3 | 20 |
| Charging time, h | 4 | 5 |
| Battery | 3.7 V / 5200 mAh Li-ion | 7.3 V / 4000 mAh Li-ion |
| Protection class | IP65 | IP67 |
| Impact protection | IK07 | IK07 |
| Impact resistance | 1 m | 1 m |
| Cable | 5 m / 2 x 1.0 mm ² H05RN-F | 1 m USB |
| Operating voltage AC | - | - |
| Charging voltage/current DC | 4.2 V / 3.5 A | 5 V / 2 A |
| Power consumption | Max 13 W | Max 16 W |
| Charger incl. | Yes | Yes |
| Temperature | -10 to +40 °C | -10 to +40 °C |
| Dimensions | ø25 x 1017 mm | 1135 x 220 x 163 mm |
| Net weight | 470 g (980 g incl. rack) | 1.69 kg (NOVA R 790 g) |
| Price | € 169.90 | € 149.90 |



Headlamps



Upgraded 2023



NEW



| | ZONE 2 | ZOOM | NIGHT VIEW |
|-----------------------------------|-------------------------|------------------------|--------------------------|
| Product number | 03.5850 | 03.5627 | 03.5438 |
| Light source | COB LED | LED | Ultra high CRI + COB LED |
| LED performance, lumen/W | 155 | 120 | 100 |
| Luminous flux, lumen | 20/100/200 (Step 1/2/3) | 10/80/220 (Step 1/2/3) | 80-160 |
| Adjustable light output | 3 levels | 3 levels | 2 levels |
| Beam angle | 120° / 60° | 10° / 60° | 120° / 60° |
| CRI | Ra > 80 | Ra > 80 | Ra > 80 |
| CCT | 6000 K | 6000 K | 6000 K RED 632 nm |
| Operating time with max. lumen, h | 2 | 4.5 | 2.5 |
| Operating time with min. lumen, h | 22 | 19 | 5 |
| Charging time, h | 2.5 | 2.5 | 4 |
| Battery | 3.7 V / 1200 mAh Li-ion | 3.7V/2000 mAh Li-ion | 3.8 V / 1600 mAh Li-ion |
| Protection class | IP54 | IP54 | IP65 |
| Impact protection | IK07 | IK07 | IK07 |
| Impact resistance | 1 m | 1 m | 1 m |
| Cable | 1 m USB | 1 m USB | 1 m USB |
| Operating voltage AC | - | - | - |
| Charging voltage/current DC | 5 V / 1 A | 5 V / 1 A | 5 V / 1 A |
| Power consumption | Max 2.5 W | Max 5.5 W | Max 3 W |
| Charger incl. | No | No | Country depended |
| Temperature | -10 to +40 °C | -10 to +40 °C | -10 to +40 °C |
| Dimensions | 84 x 31 x 37 mm | 78 x 46.4 x 46.6 mm | 105 x 52 x 43 mm |
| Net weight | 75 g | 109 g | 130 g |
| Price | € 39.90 | € 29.90 | € 84.90 |

Headlamps



Optional accessory for 03.5626 I-VIEW



| | I-VIEW | POWERBANK |
|-----------------------------------|-------------------------|-------------------|
| Product number | 03.5626 | 03.5782 |
| Light source | COB LED | - |
| LED performance, lumen/W | 175 | - |
| Luminous flux, lumen | 40-400 | - |
| Adjustable light output | Stepless | - |
| Beam angle | 120° / 60° | - |
| CRI | Ra > 80 | - |
| CCT | 6000 K | - |
| Operating time with max. lumen, h | 1.5 | - |
| Operating time with min. lumen, h | 15 | - |
| Charging time, h | 3.5 | 3 |
| Battery | 3.8 V / 1600 mAh Li-ion | 3.65 V / 4000 mAh |
| Protection class | IP65 | IP20 |
| Impact protection | IK07 | IK07 |
| Impact resistance | 1 m | 1 m |
| Cable | 1 m USB | Spiral cable |
| Operating voltage AC | - | - |
| Charging voltage/current DC | 5 V / 1 A | 5 V / 2 A |
| Power consumption | Max 3.25 W | Max 8 W |
| Charger incl. | No | - |
| Temperature | -10 to +40 °C | -10 to +40 °C |
| Dimensions | 100 x 50 x 38 mm | ø28 x 103 mm |
| Net weight | 100 g | 132 g |
| Price | € 71.90 | € 29.90 |

Accessories NEW

| | Product number | Price |
|---|----------------|----------------|
|  <p>I-VIEW HARD HAT BRACKET Incl. 3 pcs adhesive bases 103 x 33,5 x 28 mm 22 g</p> | 03.5797 | € 14.90 |
|  <p>ADHESIVE MOUNTING BASES For 03.5797 HARD HAT BRACKET</p> | 03.5798 | € 7.90 |

Headlamps



| | HEAD LITE S | HEAD LITE A | HEAD LITE |
|-----------------------------------|--------------------------------------|--------------------------|-------------------------|
| Product number | 03.5645 | 03.5670 | 03.5669 |
| Light source | COB LED | COB LED | COB LED Spot: 1 SMD LED |
| LED performance, lumen/W | 155 | 127 | 127 |
| Luminous flux, lumen | 100 | 15-150 | 15-150 Spot: 75 |
| Adjustable light output | Stepless | Stepless | Stepless |
| Beam angle | 110° | 120°/100° | 120°/100° Spot: 15° |
| CRI | Ra > 80 | Ra > 80 | Ra > 80 |
| CCT | 6000 K | 6000 K | 6000 K / 6000 K |
| Operating time with max. lumen, h | 1 | 6 | 1.5 |
| Operating time with min. lumen, h | 10 | 60 | 15 |
| Charging time, h | - | - | 3 |
| Battery | Excl. (use 2 x AAA / 1.5 V Alkaline) | 3 x AAA / 1.5 V Alkaline | 3.7 V / 800 mAh Li-ion |
| Protection class | IP30 | IP54 | IP54 |
| Impact protection | IK07 | IK07 | IK07 |
| Impact resistance | 1 m | 1 m | 1 m |
| Cable | - | - | 1 m USB |
| Operating voltage AC | - | - | - |
| Charging voltage/current DC | 5 V / 1 A | 5 V / 1 A | 5 V / 1 A |
| Power consumption | Max 1.5 W | Max 2 W | Max 2 W |
| Charger incl. | - | - | No |
| Temperature | -10 to +40 °C | -10 to +40 °C | -10 to +40 °C |
| Dimensions | 55 x 32.5 x 22 mm | 70 x 35 x 40 mm | 74 x 41 x 41 mm |
| Net weight | 65 g | 100 g | 73 g |
| Price | € 14.90 | € 21.90 | € 32.90 |

Lighting to wear



| | FLEX WEAR |
|-----------------------------------|-----------------------------|
| Product number | 03.5810 |
| Light source | COB LED / LED |
| LED performance, lumen/W | 160 |
| Luminous flux, lumen | 75/150 (Step 1/2) Spot: 100 |
| Adjustable light output | 2 levels |
| Beam angle | 110° / 14° |
| CRI | Ra > 80 |
| CCT | 6000 K |
| Operating time with max. lumen, h | 2 |
| Operating time with min. lumen, h | 4 |
| Charging time, h | 2.5 |
| Battery | 3.7V/800 mAh Li-ion |
| Protection class | IP20 |
| Impact protection | IK07 |
| Impact resistance | 1 m |
| Cable | 1 m USB |
| Operating voltage AC | - |
| Charging voltage/current DC | 5 V / 1 A |
| Power consumption | Max 1.5 W |
| Charger incl. | No |
| Temperature | -10 to +40 °C |
| Dimensions | 89 x 26 x 21 mm |
| Net weight | 42 g |
| Price | € 30.90 |

FLEX WEAR KIT NEW

| | Product number | Price |
|--|----------------|----------------|
| | 03.5811 | € 41.90 |
| FLEX WEAR KIT: FLEX WEAR including headband and cap mount | | |

NOVA
rechargeable series

| | NOVA MINI | NOVA R | NOVA 4K C+R | NOVA 6K C+R |
|-----------------------------------|-------------------------|-------------------------|--|--|
| Product number | 03.6010 | 03.5456 | 03.5441 | 03.5443 |
| Light source | High efficiency COB LED | High efficiency COB LED | High efficiency COB LED | High efficiency COB LED |
| LED performance, lumen/W | 155 | 160 | 170 | 160 |
| Luminous flux, lumen | 100-1000 | 200-2000 | 400-4000 | 600-6000 |
| Adjustable light output | Stepless | 5 levels | 5 levels | 5 levels |
| Beam angle | - | - | - | - |
| CRI | Ra > 80 | Ra > 80 | Ra > 80 | Ra > 80 |
| CCT | 6000 K | 6000 K | 6000 K | 6000 K |
| Operating time with max. lumen, h | 1.5 | 2 | 1 | 1 |
| Operating time with min. lumen, h | 15 | 20 | 14 | 12 |
| Charging time, h | 5 | 5 | 2 | 2 |
| Battery | 3.65 V / 4000 mAh | 7.3 V / 4000 mAh Li-ion | 11.1 V / 4400 mAh Li-ion | 11.1 V / 5200 mAh Li-ion |
| Protection class | IP65 | IP67 | IP67 | IP67 |
| Impact protection | IK07 | IK07 | IK07 | IK07 |
| Impact resistance | 1 m | 1 m | 1 m | 1 m |
| Cable | 1 m USB | 1 m USB | 5 m / 2 x 0.75 mm ² H05RN-F | 5 m / 2 x 0.75 mm ² H05RN-F |
| Operating voltage AC | - | - | - | - |
| Charging voltage/current DC | 5 V / 1 A | 5 V / 2 A | 12.6 V / 2.4 A | 12.6 V / 4.3 A |
| Power consumption | Max 10 W | Max 16 W | Max 29 W | Max 42 W |
| Charger incl. | No | Yes | Yes | Yes |
| Temperature | -10 to +40 °C | -10 to +40 °C | -10 to +40 °C | -10 to +40 °C |
| Dimensions | 104 x 38 x 96 mm | 163 x 63 x 163 mm | 235 x 88 x 233 mm | 267 x 87 x 262 mm |
| Net weight | 254 g | 790 g | 2.3 kg | 2.91 kg |
| Price | € 74.90 | € 104.90 | € 209.90 | € 249.90 |

 NOVA
cable series

| | NOVA 4K | NOVA 6K | NOVA 12 K |
|-----------------------------------|-------------------------------------|-------------------------------------|-------------------------------------|
| Product number | 03.5440 | 03.5442 | 03.5444 |
| Light source | High efficiency COB LED | High efficiency COB LED | High efficiency COB LED |
| LED performance, lumen/W | 160 | 160 | 170 |
| Luminous flux, lumen | 400-4000 | 600-6000 | 1200-12000 |
| Adjustable light output | 5 levels | 5 levels | 5 levels |
| Beam angle | - | - | - |
| CRI | Ra > 80 | Ra > 80 | Ra > 80 |
| CCT | 6000 K | 6000 K | 6000 K |
| Operating time with max. lumen, h | - | - | - |
| Operating time with min. lumen, h | - | - | - |
| Battery | - | - | - |
| Protection class | IP67 | IP67 | IP67 |
| Impact protection | IK07 | IK07 | IK07 |
| Impact resistance | 1 m | 1 m | 1 m |
| Cable | 5 m / 3 x 1 mm ² H05RN-F | 5 m / 3 x 1 mm ² H05RN-F | 5 m / 3 x 1 mm ² H05RN-F |
| Operating voltage AC | 100-240 V | 100-240 V | 100-240 V |
| Charging voltage/current DC | - | - | - |
| Power consumption | Max 30 W | Max 42 W | Max 86 W |
| Charger incl. | - | - | - |
| Temperature | -10 to +40 °C | -10 to +40 °C | -10 to +40 °C |
| Dimensions | 235 x 88 x 233 mm | 267 x 87 x 262 mm | 302 x 102 x 298 mm |
| Net weight | 2.38 kg | 2.66 kg | 4 kg |
| Price | € 134.90 | € 154.90 | € 279.90 |

VEGA LITE series



| | VEGA LITE C+R | VEGA LITE COMPACT | VEGA LITE | VEGA LITE COLOUR |
|-----------------------------------|--|---------------------------------------|---------------------------------------|---------------------------------------|
| Product number | 03.5451 | 03.5673 | 03.5453 | 03.5459 |
| Light source | 66 SMD LED | 83 SMD LED | 123 SMD LED | 123 SMD LED |
| LED performance, lumen/W | 189 | 189 | 189 | 189 |
| Luminous flux, lumen | 1250-2500 | 4000 | 6000 | 5000 |
| Adjustable light output | 2 levels | - | - | - |
| Beam angle | 100° | 100° | 100° | 100° |
| CRI | Ra > 80 | Ra > 80 | Ra > 80 | Ra > 80 |
| CCT | 6000 K | 6000 K | 6000 K | 2500 K - 4500 K - 6500 K |
| Operating time with max. lumen, h | 1.5 | 2 | - | - |
| Operating time with min. lumen, h | 3 | 20 | - | - |
| Charging time, h | 1.5 | 5 | - | - |
| Battery | 11.1 V / 2600 mAh Li-ion | 7.3 V / 4000 mAh Li-ion | - | - |
| Protection class | IP54 | IP67 | IP54 | IP54 |
| Impact protection | IK07 | IK07 | IK07 | IK07 |
| Impact resistance | - | - | - | - |
| Cable | 5 m / 2 x 0.75 mm ² H05RN-F | 3 m / 3 x 1.5 mm ² H05RN-F | 5 m / 3 x 1.5 mm ² H07RN-F | 5 m / 3 x 1.5 mm ² H07RN-F |
| Operating voltage AC | 100-240 V | 100-240 V | 100-240 V | 100-240 V |
| Charging voltage/current DC | 12.6 V / 2.4 A | - | - | - |
| Power consumption | Max 18 W | Max 32 W | Max 45 W | Max 45 W |
| Charger incl. | Yes | - | - | - |
| Temperature | -10 to +40 °C | -10 to +40 °C | -10 to +40 °C | -10 to +40 °C |
| Dimensions | 288 x 103 x 280 mm | 288 x 103 x 280 mm | 318 x 117 x 310 mm | 318 x 117 x 310 mm |
| Net weight | 2.59 kg | 2.46 kg | 3.43 kg | 3.69 kg |
| Price | € 129.90 | € 129.90 | € 149.90 | € 179.90 |

AREA LITE 360°



| | AREA LITE CO |
|-----------------------------------|-------------------------------------|
| Product number | 03.5637 |
| Light source | 168 SMD LED |
| LED performance, lumen/W | 189 |
| Luminous flux, lumen | 6000 |
| Adjustable light output | No |
| Beam angle | 360° |
| CRI | Ra > 80 |
| CCT | 6000 K |
| Operating time with max. lumen, h | - |
| Operating time with min. lumen, h | - |
| Battery | - |
| Protection class | IP54 |
| Impact protection | IK07 |
| Impact resistance | 1 m |
| Cable | 5 m / 3 x 1 mm ² H05RN-F |
| Operating voltage AC | 220-240 V |
| Charging voltage/current DC | - |
| Power consumption | Max 45 W |
| Charger incl. | - |
| Temperature | -10 to +30 °C |
| Dimensions | 305 x 199 mm |
| Net weight | 2.95 kg |
| Price | € 159.90 |

SCANGRIP PRODUCT LINES



Specialized work lights for the painting industry



Explosion proof lights



Portable lights for fast curing



One lighting solution for all battery packs

SITE LIGHT series



| | SITE LIGHT 40 | SITE LIGHT 80 | ROPE LIGHT |
|-----------------------------------|--------------------------------------|--------------------------------------|---|
| Product number | 03.5268 | 03.5269 | 03.5815 |
| Light source | 432 SMD LEDs | 864 SMD LEDs | 120 SMD LEDs/m |
| LED performance, lumen/W | 189 | 189 | 116 |
| Luminous flux, lumen | 10000-40000 | 20000-80000 | 20000 |
| Adjustable light output | 4 levels | 4 levels | No |
| Beam angle | 120° | 120° | 120° |
| CRI | Ra > 80 | Ra > 80 | Ra > 80 |
| CCT | 6000 K | 6000 K | 6000 K |
| Operating time with max. lumen, h | - | - | - |
| Operating time with min. lumen, h | - | - | - |
| Charging time, h | - | - | - |
| Battery | - | - | - |
| Protection class | IP65 | IP65 | IP65 |
| Impact protection | IK08 | IK08 | IK07 |
| Impact resistance | 1 m | 1 m | 1 m |
| Cable | 10 m / 3 x 1 mm ² H07RN-F | 10 m / 3 x 1 mm ² H07RN-F | 1.5 m / 2 x 1.0 mm ² H05RN-F |
| Operating voltage AC | 220-240 V | 220-240 V | 220-240 V |
| Charging voltage/current DC | - | - | - |
| Power consumption | Max 315 W | Max 630 W | Max 205 W |
| Charger incl. | - | - | - |
| Temperature | -25 to +40 °C | -25 to +40 °C | -20 to +40 °C |
| Dimensions | 278 x 241 x 160 mm | 415 x 241 x 160 mm | ø200 x 325 mm |
| Net weight | 4.95 kg | 6.70 kg | 4.68 kg |
| Price | € 669.90 | € 1069.90 | € 399.90 |

MINI LITE A



| | MINI LITE A |
|-----------------------------------|------------------------|
| Product number | 03.5102 |
| Light source | LG |
| LED performance, lumen/W | 158 |
| Luminous flux, lumen | 100 |
| Adjustable light output | No |
| Beam angle | 10° |
| Beam distance | Up to 80 m |
| CRI | Ra > 75 |
| CCT | 6000 K |
| Operating time with max. lumen, h | 4.5 |
| Operating time with min. lumen, h | - |
| Charging time, h | - |
| Battery | 3xAAA / 1.5 V Alkaline |
| Protection class | IP54 |
| Impact protection | - |
| Impact resistance | 1 m |
| Cable | - |
| Charging voltage/current DC | - |
| Power consumption | Max 2 W |
| Charger incl. | - |
| Temperature | -10 to +40 °C |
| Dimensions | ø28 x 102 mm |
| Net weight | 72 g |
| Price | € 8.90 |

FLASH series



| | FLASH PENCIL | FLASH PEN | FLASH 300 | FLASH 600 | FLASH MICRO R |
|-----------------------------------|---------------------------|--------------------------|--------------------------|------------------------|------------------------|
| Product number | 03.5130 | 03.5131 | 03.5132 | 03.5133 | 03.5113 |
| Light source | LUMILEDS | CREE | CREE | CREE | LED |
| LED performance, lumen/W | 124 | 142 | 165 | 165 | 103 |
| Luminous flux, lumen | 75 | 100-200 | 150-300 | 300-600 | 7.5-75 |
| Adjustable light output | No | BOOST mode | BOOST mode | BOOST mode | Stepless |
| Beam angle | 15° | 10°-60° | 10°-60° | 10°-60° | 110° |
| Beam distance | 40 m | 80 m | 100 m | 150 m | 10 m |
| CRI | Ra > 70 | Ra > 70 | Ra > 65 | Ra > 65 | Ra > 80 |
| CCT | 6000 K | 6000 K | 6000 K | 6000 K | 6000 K |
| Operating time with max. lumen, h | 2.5 | 3.5 | 3 | 2 | 0.25 |
| Operating time with min. lumen, h | - | - | - | - | 2.5 |
| Charging time, h | - | - | - | - | 2.5 |
| Battery | 2 x AAAA / 1.5 V Alkaline | 2 x AAA / 1.5 V Alkaline | 3 x AAA / 1.5 V Alkaline | 2 x C / 1.5 V Alkaline | 3.7 V / 100 mAh Li-ion |
| Protection class | IP54 | IP54 | IP54 | IP54 | IP20 |
| Impact protection | IK07 | IK07 | IK07 | IK07 | - |
| Impact resistance | 1 m | 1 m | 1 m | 1 m | 1 m |
| Cable | - | - | - | - | USB cable |
| Charging voltage/current DC | - | - | - | - | - |
| Power consumption | Max 1.6 W | Max 1.2 W | Max 4.8 W | Max 7 W | Max 1.2 W |
| Charger incl. | - | - | - | - | - |
| Temperature | -10 to +40 °C | -10 to +40 °C | -10 to +40 °C | -10 to +40 °C | -10 to +40 °C |
| Dimensions | ø15 x 131 mm | ø20 x 153 mm | ø32 x 133 mm | ø36 x 174 mm | 55 x 15 x 25 mm |
| Net weight | 32 g | 62 g | 122 g | 292 g | 17 g |
| Price | € 19.90 | € 27.90 | € 34.90 | € 44.90 | € 14.90 |

FLASH R series



| | FLASH 12-24V | WORK PEN 200 R | FLASH PEN R | FLASH 600 R | FLASH 1000 R |
|-----------------------------------|--------------------------|------------------------|-------------------------|-------------------------|-------------------------|
| Product number | 03.5124 | 03.5127 | 03.5136 | 03.5137 | 03.5138 |
| Light source | SAMSUNG LED | COB LED / CREE | CREE | CREE | CREE |
| LED performance, lumen/W | 140 | 120 | 165 | 165 | 148 |
| Luminous flux, lumen | 130 | 20-200 Spot: 150 | 150-300 | 300-600 | 500-1000 |
| Adjustable light output | No | Stepless | BOOST mode | BOOST mode | BOOST mode |
| Beam angle | 10°-70° | 105° / 20° | 10°-60° | 10°-70° | 10°-60° |
| Beam distance | 100 m | 40 m | 100 m | 150 m | 250 m |
| CRI | Ra > 70 | Ra > 80 | Ra > 65 | Ra > 65 | Ra > 70 |
| CCT | 6000 K | 6000 K | 6000 K | 6000 K | 6000 K |
| Operating time with max. lumen, h | 1 | 1 | 7 | 7 | 5 |
| Operating time with min. lumen, h | - | 10 | - | - | - |
| Charging time, h | 2 | 2.5 | 3 | 4 | 4 |
| Battery | 3.7 V / 550 mAh Li-ion | 3.7 V / 750 mAh Li-ion | 3.7 V / 1100 mAh Li-ion | 3.7 V / 2600 mAh Li-ion | 3.7 V / 4000 mAh Li-ion |
| Protection class | IP30 | IP30 | IP54 | IP54 | IP54 |
| Impact protection | IK07 | IK07 | IK07 | IK07 | IK07 |
| Impact resistance | 1 m | 1 m | 1 m | 1 m | 1 m |
| Cable | Cigarette Plug Connector | 1 m USB | 1 m USB | 1 m USB | 1 m USB |
| Charging voltage/current DC | 10-28 V | 5 V / 1 A | 5 V / 1 A | 5 V / 1 A | 5 V / 2 A |
| Power consumption | Max 2 W | 4 W | 4 W | 6 W | 12 W |
| Charger incl. | No | No | No | No | No |
| Temperature | -10 to +40 °C | -10 to +40 °C | -10 to +40 °C | -10 to +40 °C | -10 to +40 °C |
| Dimensions | ø30 x 105 mm | ø21 x 172 mm | ø24 x 169 mm | ø38 x 185 mm | ø42 x 196 mm |
| Net weight | 88 g (100 g with cover) | 54 g | 83 g | 253 g | 345 g |
| Price | € 29.90 | € 29.90 | € 39.90 | € 59.90 | € 69.90 |

LINE LIGHT series



| | LINE LIGHT 2-POST | LINE LIGHT 1 | LINE LIGHT 2 | LINE LIGHT 4 | LINE LIGHT 6 |
|-----------------------------------|--|--|--|--|--|
| Product number | 03.5225 | 03.5203 | 03.5202 | 03.5201 | 03.5200 |
| Light source | 2 x 96 SMD LED | 216 SMD LED | 2 x 156 SMD LED | 4 x 216 SMD LED | 6 x 216 SMD LED |
| LED performance, lumen/W | 189 | 189 | 189 | 189 | 189 |
| Luminous flux, lumen | 2 x 12.5-1250 | 2750 | 2 x 2000 | 4 x 2750 | 6 x 2750 |
| Illuminance, lux@0.5 m | 2 x 20-2000 | 3000 | 2 x 2800 | 4 x 27.5-2750 | 6 x 3000 |
| Adjustable light output | Stepless | No | No | Stepless | No |
| Beam angle | 75° | 75° | 75° | 75° | 75° |
| CRI | Ra > 80 | Ra > 80 | Ra > 80 | Ra > 80 | Ra > 80 |
| CCT | 6000 K | 6000 K | 6000 K | 6000 K | 6000 K |
| Operating time with max. lumen, h | - | - | - | - | - |
| Operating time with min. lumen, h | - | - | - | - | - |
| Charging time, h | - | - | - | - | - |
| Battery | - | - | - | - | - |
| Protection class | IP67 | IP67 | IP67 | IP67 | IP67 |
| Impact protection | IK07 | IK07 | IK07 | IK07 | IK07 |
| Impact resistance | 1 m | 1 m | 1 m | 1 m | 1 m |
| Cable | 8 m / H03VV-F 2 x 0.5 mm ² | 8 m / H03VV-F 2 x 0.5 mm ² | 8 m / H03VV-F 2 x 0.5 mm ² | 8 m / H03VV-F 2 x 0.5 mm ² | 8 m / H03VV-F 2 x 0.5 mm ² |
| Operating voltage AC | - | - | - | - | - |
| Charging voltage/current DC | 24 V | 24 V | 24 V | 24 V | 24 V |
| Power consumption | Max 2 x 24 W | Max 26 W | Max 2 x 38 W | Max 4 x 104 W | Max 6 x 156 W |
| Power supply incl. | 25 W POWER SUPPLY UNIT 03.5229 | 25 W POWER SUPPLY UNIT 03.5229 | 80 W POWER SUPPLY UNIT 03.5226 | 80 W POWER SUPPLY UNIT 03.5226 | 2 x 80 W POWER SUPPLY UNIT 03.5226 |
| Temperature | -10 to +40 °C | -10 to +40 °C | -10 to +40 °C | -10 to +40 °C | -10 to +40 °C |
| Dimensions | 2 x ø25 x 770 mm | ø25 x 1630 mm | 2 x ø25 x 1234 mm | 4 x ø25 x 1630 mm | 6 x ø25 x 1630 mm |
| Net weight* | 4.1 kg | 2.03 kg | 4.52 kg | 6.7 kg | 10.24 kg |
| Price | € 403.90 | € 241.90 | € 393.90 | € 1009.90 | € 1514.90 |

*Weight includes all parts and accessories included

LINE LIGHT series



| | LINE LIGHT 75 | LINE LIGHT 120 | LINE LIGHT 160 | LINE LIGHT 200 |
|-----------------------------------|-----------------|-----------------|-----------------|-----------------|
| Product number | 03.5221 | 03.5222 | 03.5223 | 03.5224 |
| Light source | 96 SMD LED | 156 SMD LED | 216 SMD LED | 276 SMD LED |
| LED performance, lumen/W | 189 | 189 | 189 | 189 |
| Luminous flux, lumen | 1250 | 2000 | 2750 | 3500 |
| Illuminance, lux@0.5 m | 2000 | 2800 | 3000 | 3200 |
| Adjustable light output | No | No | No | No |
| Beam angle | 75° | 75° | 75° | 75° |
| CRI | Ra > 80 | Ra > 80 | Ra > 80 | Ra > 80 |
| CCT | 6000 K | 6000 K | 6000 K | 6000 K |
| Operating time with max. lumen, h | - | - | - | - |
| Operating time with min. lumen, h | - | - | - | - |
| Charging time, h | - | - | - | - |
| Battery | - | - | - | - |
| Protection class | IP67 | IP67 | IP67 | IP67 |
| Impact protection | IK07 | IK07 | IK07 | IK07 |
| Impact resistance | 1 m | 1 m | 1 m | 1 m |
| Cable | - | - | - | - |
| Operating voltage AC | - | - | - | - |
| Charging voltage/current DC | 24 V | 24 V | 24 V | 24 V |
| Power consumption | Max 10 W | Max 16 W | Max 22 W | Max 28 W |
| Power supply incl. | - | - | - | - |
| Temperature | -10 to +40 °C | -10 to +40 °C | -10 to +40 °C | -10 to +40 °C |
| Dimensions | ø25 x 838 mm | ø25 x 1234 mm | ø25 x 1630 mm | ø25 x 2027 mm |
| Net weight* | 390 g | 530 g | 670 g | 860 g |
| Price | € 120.90 | € 201.90 | € 231.90 | € 272.90 |

All prices are gross prices, VAT exclusive and subject to change without notice, errors and omissions excepted.

// Certified and strictly approved

SCANGRIP's expert staff make sure that our lights meet all standards and regulations. Our work lights are manufactured at our own factories and subject to strict quality controls in full compliance with local regulations. Our lights meet the highest standards and are certified according to EU's regulations, directives, and harmonized standards. We are ISO9001 certified by Bureau Veritas.

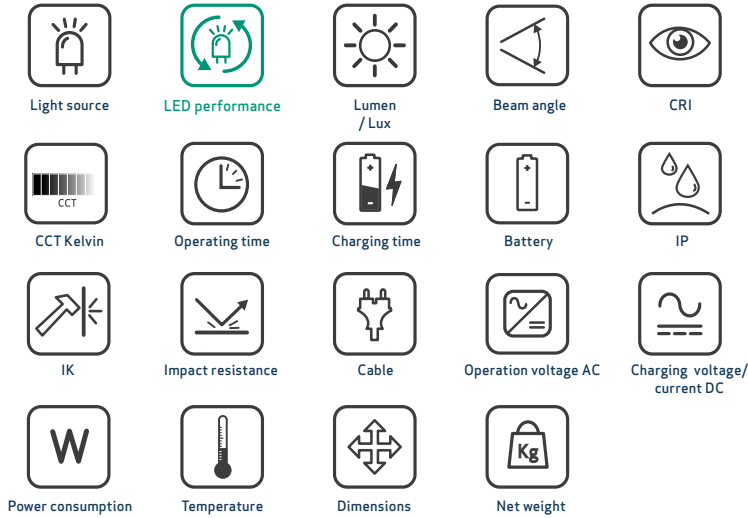

// Chargers for all countries

Electrical plugs and voltages differ from country to country around the world. SCANGRIP offers chargers to all country variants worldwide. Go to our website for a complete list of chargers for our rechargeable work lights and all other accessories available.



Combine LINE LIGHT lighting units with power supply, cable and suitable suspensions.

A range of flexible suspensions makes it possible to position the lighting units exactly where you need it.

| POWER SUPPLY/CABLE | Product number | Price |
|----------------------|------------------------|------------------------|
| | LINE LIGHT DIMMER | 03.5264 € 70.90 |
| 2 m cable 5 m cable | 25 W power supply unit | 03.5229 € 31.50 |
| 2 m cable 5 m cable | 80 W power supply unit | 03.5226 € 51.90 |
| | POWER CABLE 8 m | 03.5215 € 8.50 |

| SUSPENSIONS | Product number | Price |
|-------------|--|------------------------|
| | CLIP - 1 pc. - incl. fittings for suspension | 03.5214 € 6.70 |
| | CLIP - 1 pc. - incl. fittings for suspension | 03.5216 € 23.90 |
| | CLIP with ø30 mm magnet for suspension | 03.5279 € 20.90 |
| | LARGE MAGNET - ø60 mm with clip | 03.5276 € 26.90 |
| | FLEXIBLE MAGNET SUSPENSION - Ball socket joint with strong magnet for suspension for LINE LIGHT 2-POST | 03.5257 € 42.90 |
| | MAGNET - With small clip - ø30 mm | 03.5246 € 15.90 |
| | CLIP - Small metal clip | 03.5213 € 4.20 |





SCANGRIP is Europe's leading manufacturer of work lights for professionals providing the strongest and most comprehensive ranges of work lights with the latest LED lighting technology available on the market.

SCANGRIP is innovation from Denmark and receives strong recognition in the marketplace for its product design, and the products are known for their high quality.

SCANGRIP strives for perfection, and is continuously optimizing and improving light output, battery capacity, design and ergonomics, durability, user-friendliness, and functionality. The aim is to set new standards for professional work lights.

SCANGRIP was established in 1906 and has a long, impressive history of manufacturing high-quality hand tools and work lights for the industrial, construction, and automotive sectors.

SCANGRIP is part of Hultafors Group - a global company offering a unique portfolio of premium brands within personal protection, tools, and other equipment for discerning craftsmen. Together, we are on a mission to create a better day for professional users.

